

**ALLEMAAL
YIELEYAAL**

Tekening: **Situatie totaal**

Woningtype:

Bouwnummer:

Bladnummer: **VT-S-01**

Schaal: **1:1000**

Datum: **27-10-2021**

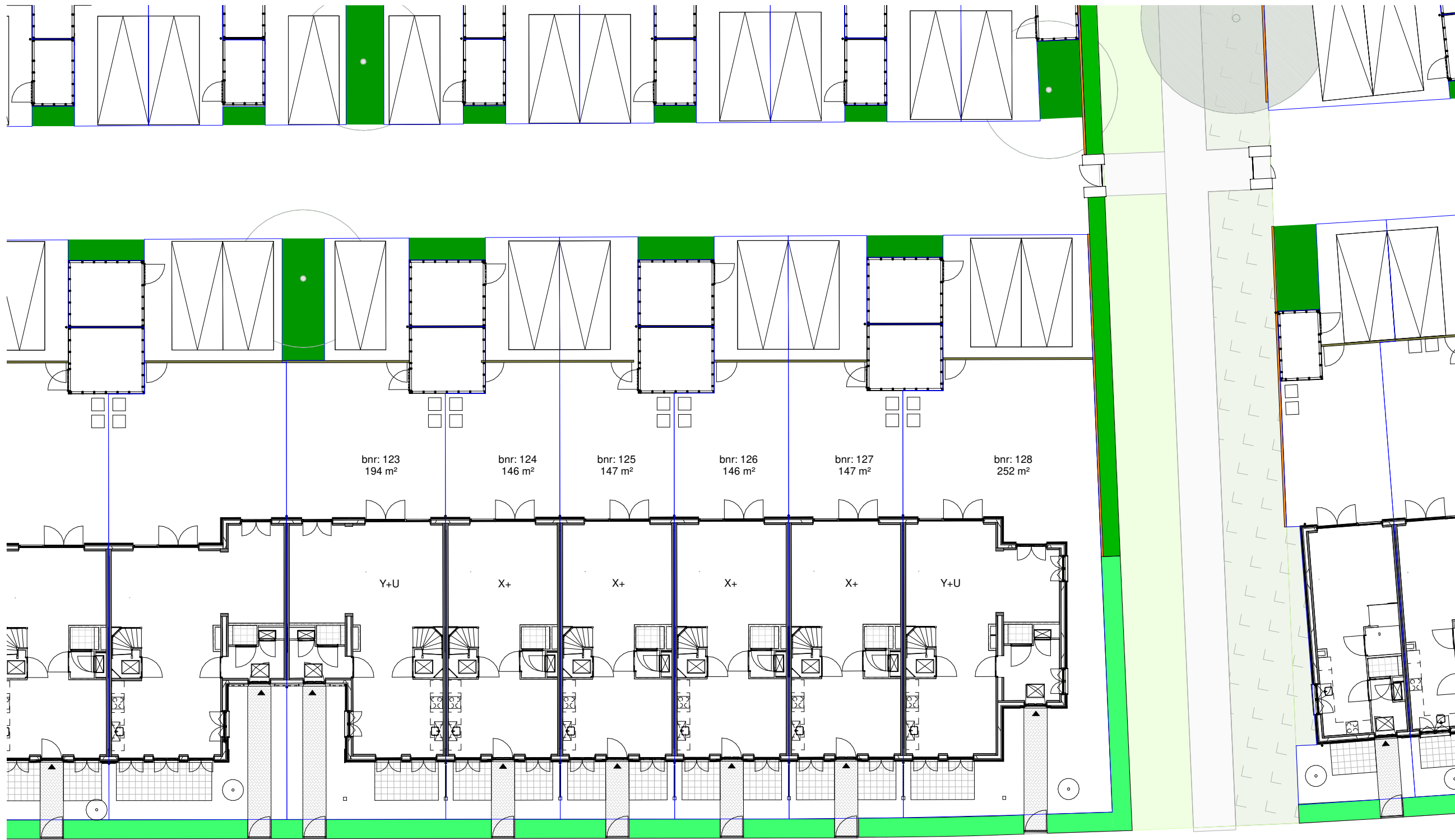

Renvooi

-  - entree woning
-  - parkeervak eigen terrein
-  - erfgrans
-  - beplanting type n.t.b. koper
-  - opstelplaats klike
-  - tuinhekje
-  - klinkerbestrating
-  - betontegels 300x300mm
-  - groen strook
-  - haag h=900mm
-  - haag h=1800mm
-  - bamboehok h=1800mm
-  - gaashek met klimplanten en poort h=1600mm

parkeerplekken en posities bomen en struiken zijn indicatief













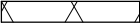

Warmoldstraat



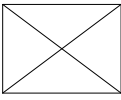

























**ALLEMAAL
YIELEYAAL**

Tekening:	Situatie blok E4
Woningtype:	Y+U, X+
Bouwnummer:	123-128
Bladnummer:	VT-S-12
Schaal:	1:200
Datum:	27-10-2021

Renvooi bouwkundig

	metselwerk kleur A
	dakpannen kleur oranje
	entree woning
	metselwerk
	isolatie
	dragende wand
	niet dragende binnenwand
	binnendeurkozijn (met bovenlicht)
	kruipluik
	opstelplaats wasmachine
	opstelplaats wasdroger
	
	principe opstelling keukenblok

Renvooi installaties

	aansluitpunt licht
	aansluitpunt licht, wand
	centraaldoos met lichtpunt
	armatuur aan de wand
	rookmelder
	aansluitpunt niet bedraad
	verdeelinrichting / meterkast / groepenkast
	beldrukker
	schel
	schakelaar, 1-polig
	werkschakelaar tbv PV-panelen
	schakelaar, 3-polig
	schakelaar, wissel
	schakelaar, kruis
	schakelaar, serie
	wandcontactdoos 1-voudig met beschermingscontact
	wandcontactdoos 2-voudig met beschermingscontact, verticaal
	wandcontactdoos 2-voudig met beschermingscontact
	thermostaatleiding, bedraad
	mechanische ventilatie-unit incl. warmteterugwinunit
	warmtepomp
	inblaasventiel mechanische ventilatie
	uitblaasventiel mechanische ventilatie
	verdeler vloerverwarming
	ruimte voorzien van vloerverwarming
	elektrische radiator
	kanalen in het zicht
	onbenoemde ruimte volgens krijstreepmethode

Disclaimer

De op deze tekeningen aangegeven maten zijn circa maten in millimeters en tussen de wanden / vloeren gemeten, waarbij geen rekening is gehouden met enige wandafwerking, plinten, aftimmering, ect. In verband met de nauwkeurige uitwerking van details, constructie, maatvoering, materialen e.d. kunnen er kleine afwijkingen ontstaan ten opzichte van de nu vermelde gegevens. Deze geringe afwijkingen geven geen aanleiding tot verrekening. Aan de op deze tekening aangegeven maten kunnen derhalve geen rechten worden ontleend. De op deze tekeningen aangegeven maatvoering is niet geschikt voor opdrachten aan derden door koper(s). De posities van aansluitingen en installatie onderdelen zijn indicatief op tekening aangegeven. De exacte aantallen en posities zullen na berekening in het werk door de installateurs worden bepaald en kunnen afwijken van deze tekening.

**ALLEMAAL
YIELEYAAL**

Tekening: Renvooi

Woningtype: -

Bouwnummer: -

Bladnummer: VT-0-00c

Schaal: -

Datum: 27-10-2021



Type: Y+U
bwnr: 123

Type: X+
bwnr: 124

Type: X+
bwnr: 125

Type: X+
bwnr: 126

Type: X+
bwnr: 127

Type: Y+U var
bwnr: 128



Type: Y+U var
bwnr: 128

Type: X+
bwnr: 127

Type: X+
bwnr: 126

Type: X+
bwnr: 125

Type: X+
bwnr: 124

Type: Y+U
bwnr: 123

ALLEMAAL
YIELEYAAL

Tekening: Gevels blok E4

Woningtype: Y+-U, X+

Bouwnummer: 123 t/m 128

Bladnummer: VT-E4-00a

Schaal: 1:150

Datum: 27-10-2021

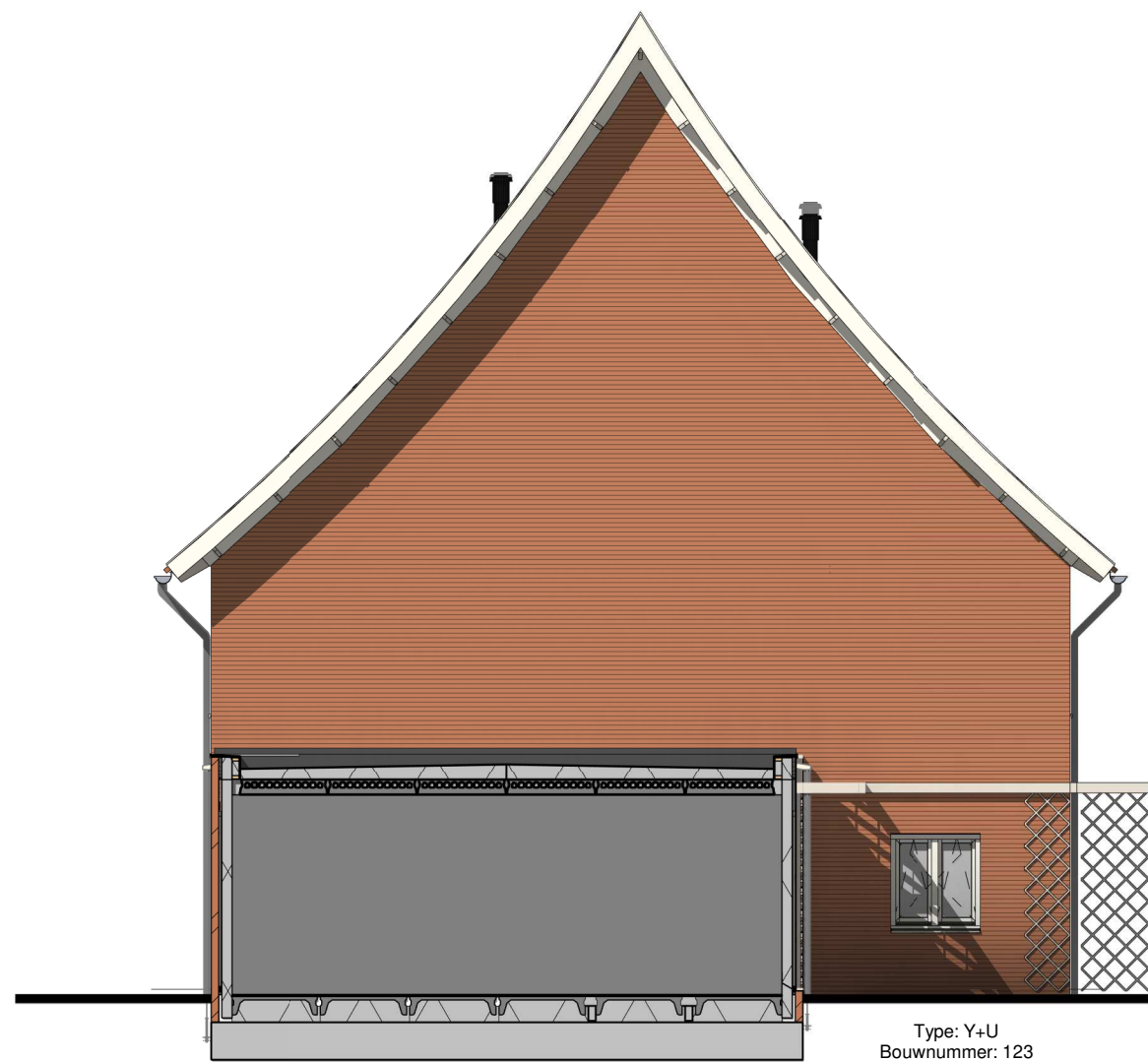

Type: Y+U
Bouwnummer: 123

Linker zijgevel

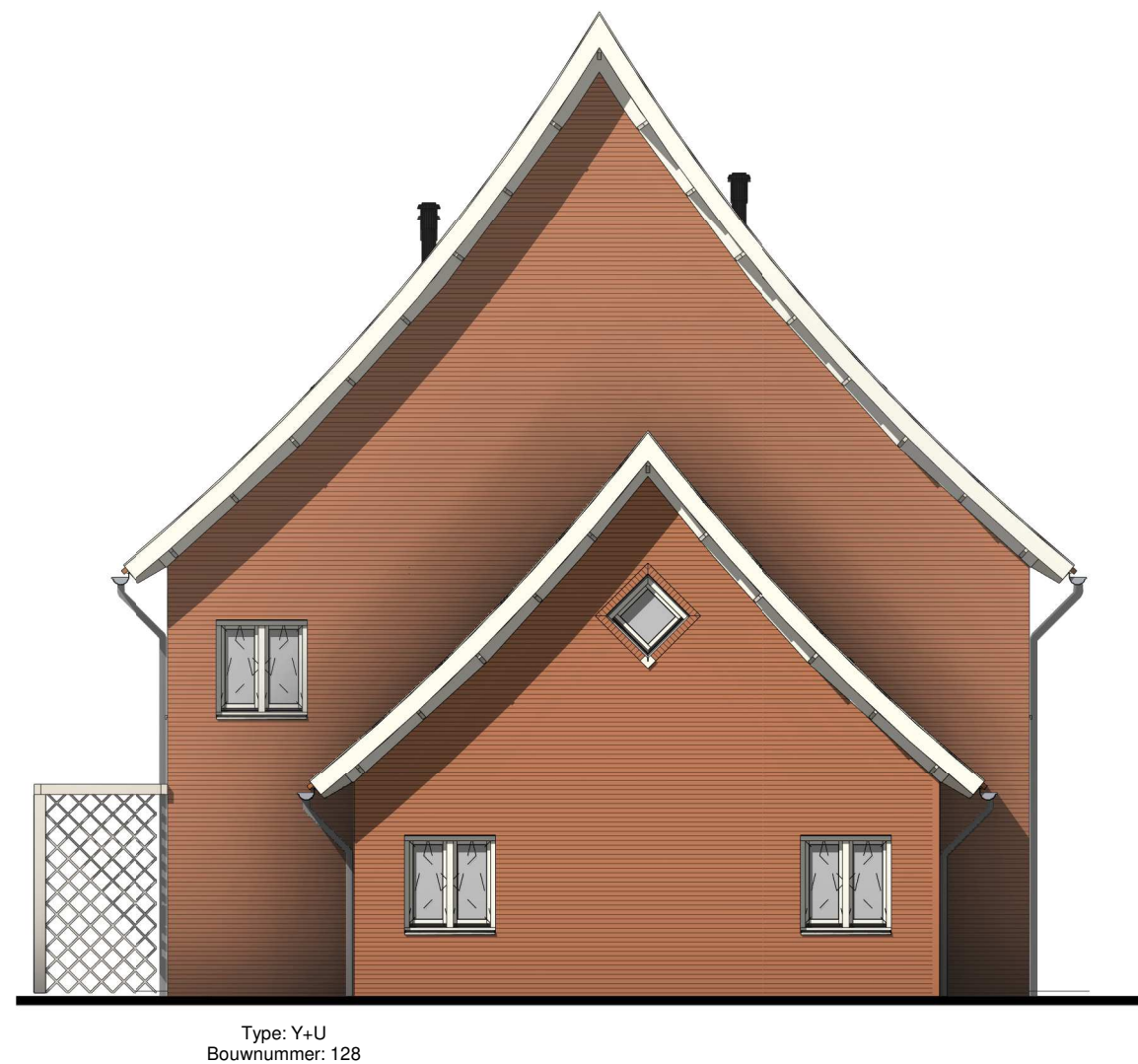

Type: Y+U
Bouwnummer: 128

Rechter zijgevel

ALLEMAAL
YIELEYAAL

Tekening: Zijgevels blok E4

Woningtype: X+, Y+U

Bouwnummer: 123 t/m 128

Bladnummer: VT-E4-00b

Schaal: 1:100

Datum: 27-10-2021

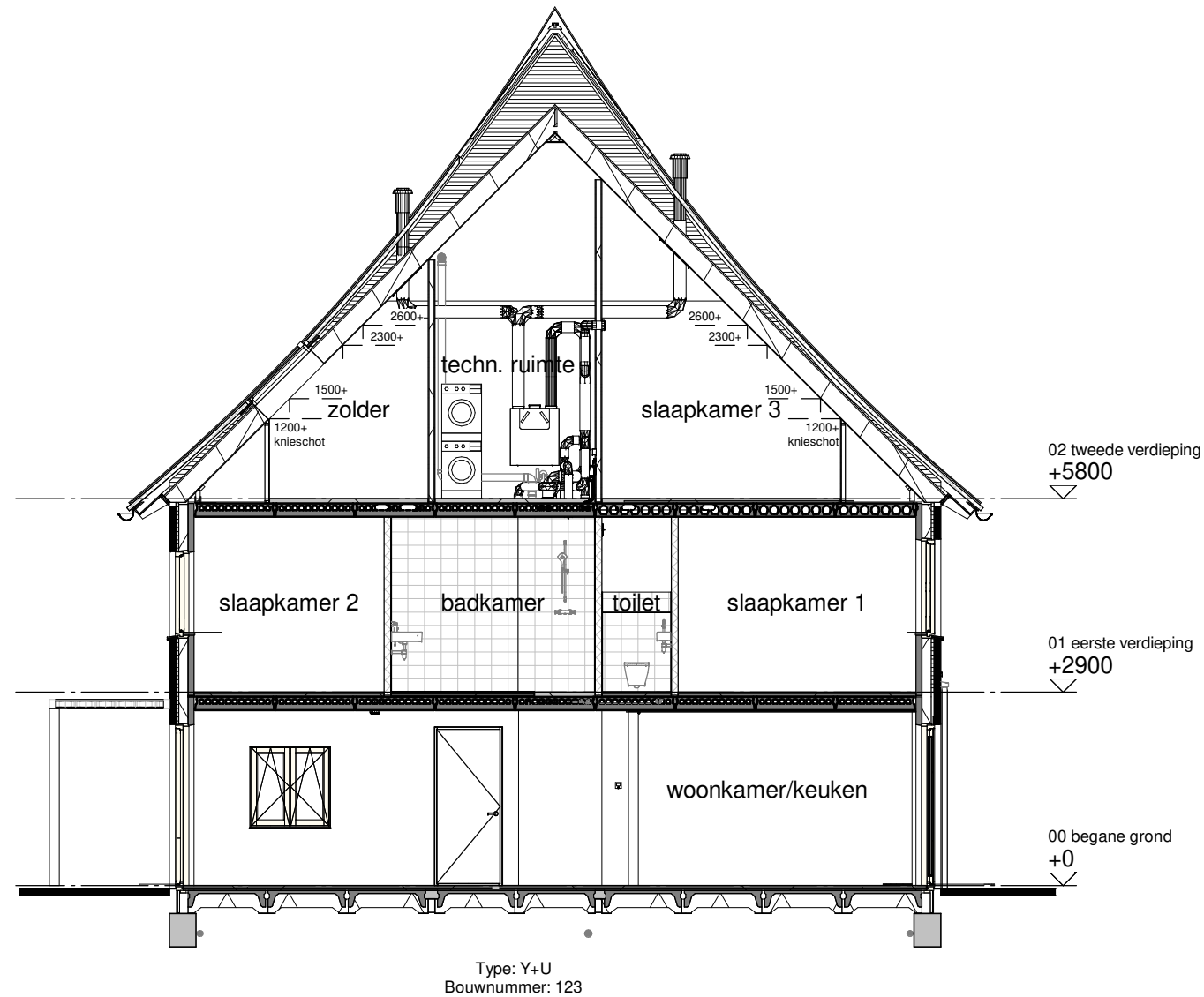

Doorsnede A

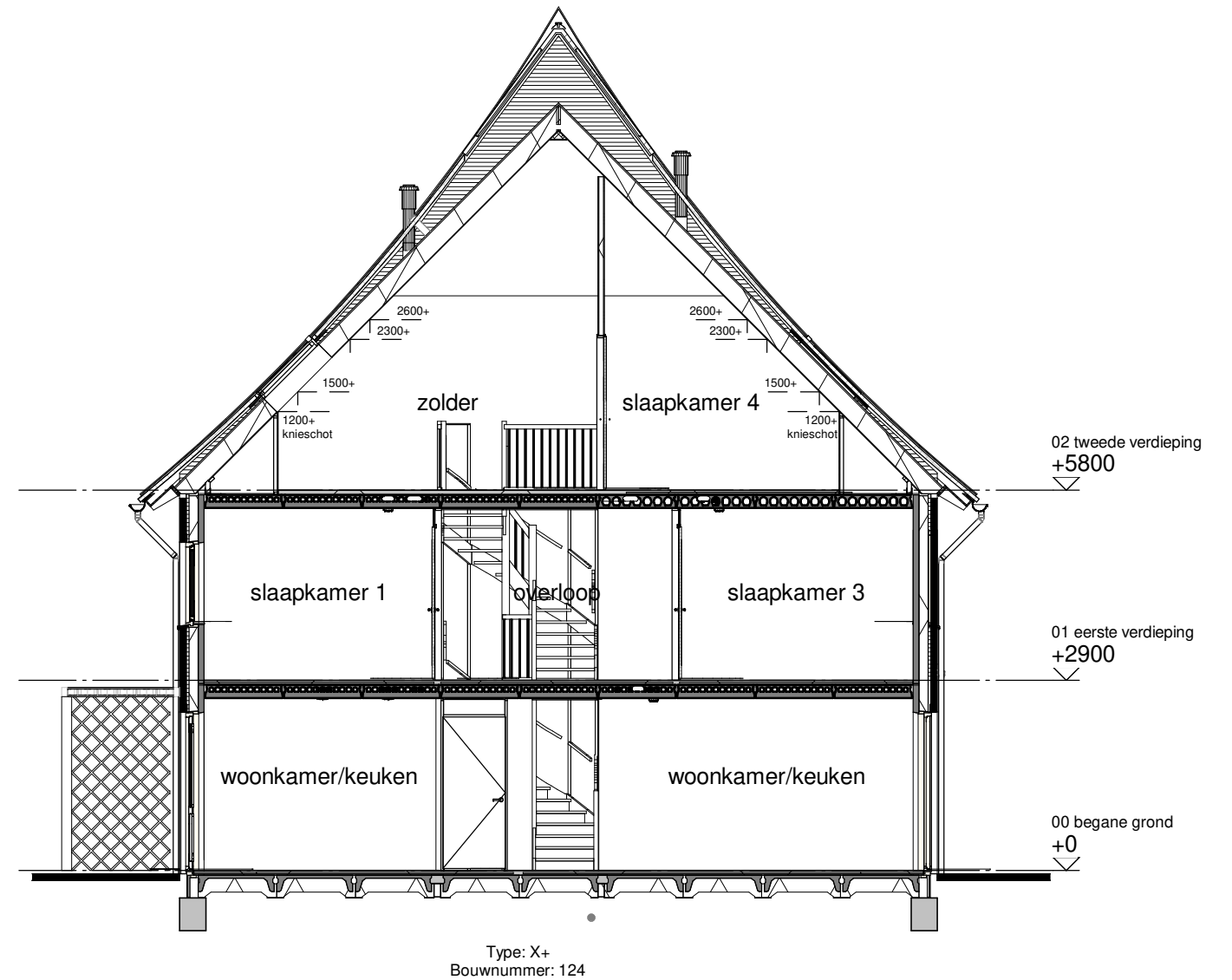

Doorsnede B

**ALLEMAAL
YIELEYAAL**

Tekening: Doorsnedes blok E4

Woningtype: Y+U, X+

Bouwnummer: 123, 124

Bladnummer: VT-E4-00c

Schaal: 1:100

Datum: 27-10-2021

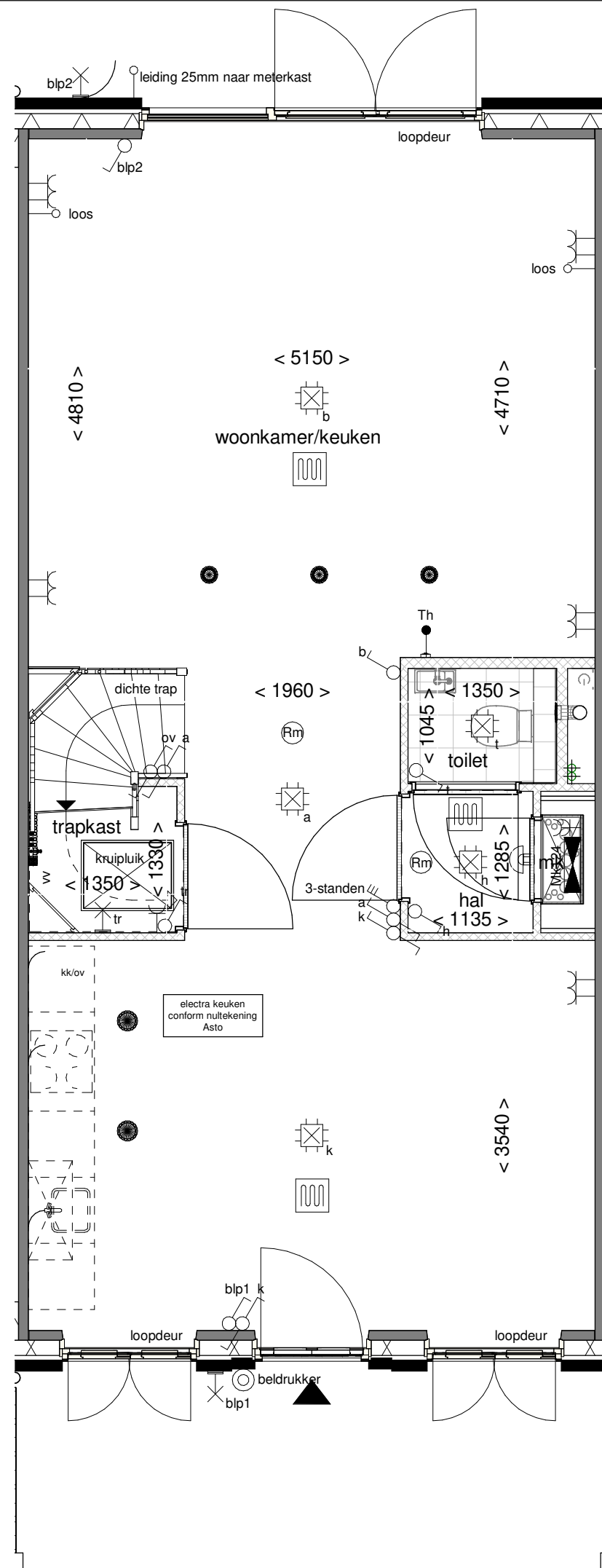

ALLEMAAL
YIELEYAAL

Tekening: Begane grond

Woningtype: X+

Bouwnummer: 124

Bladnummer: VT-E4-124a

Schaal: 1:50

Datum: 27-10-2021

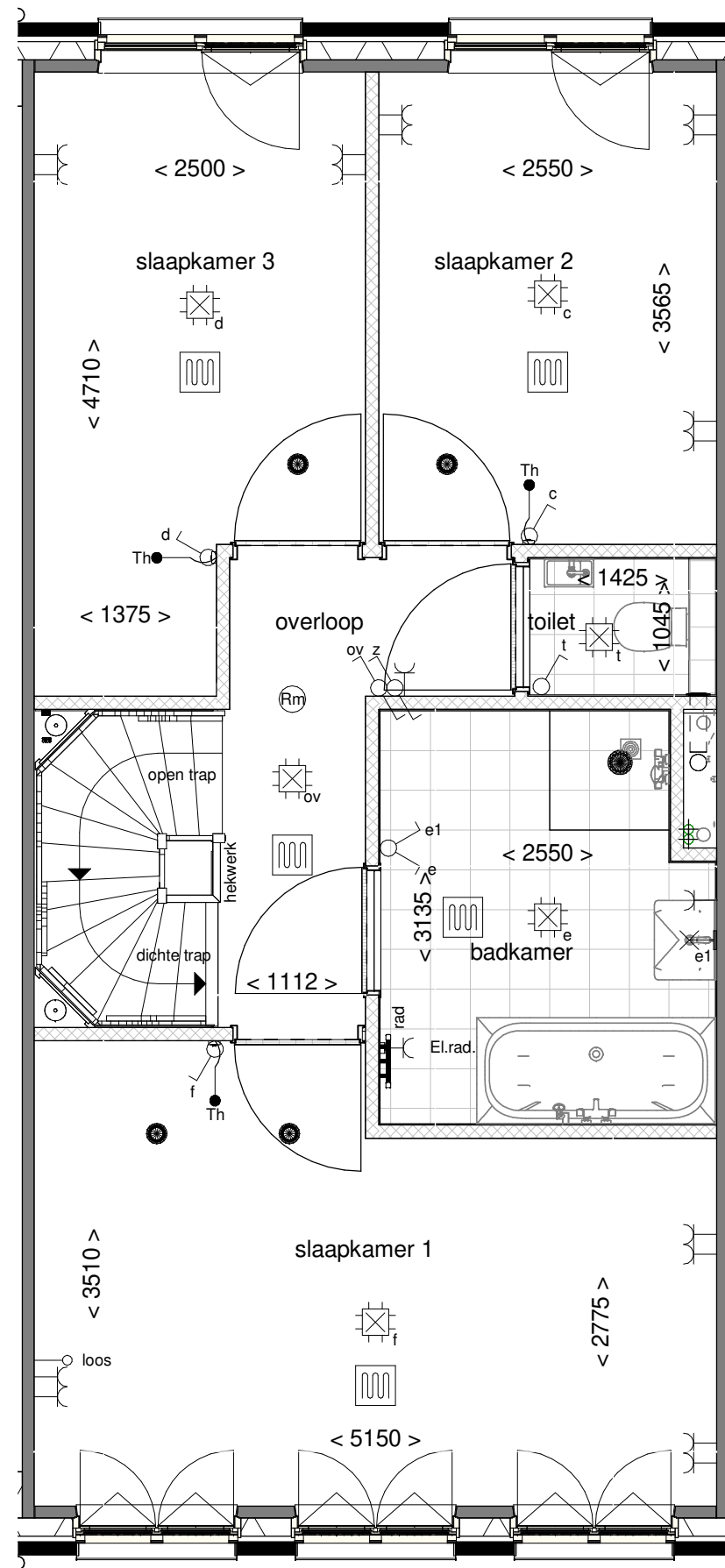

**ALLEMAAL
VIELEJAAR**

Tekening: Eerste verdieping

Woningtype: X+

Bouwnummer: 124

Bladnummer: VT-E4-124b

Schaal: 1:50

Datum: 27-10-2021

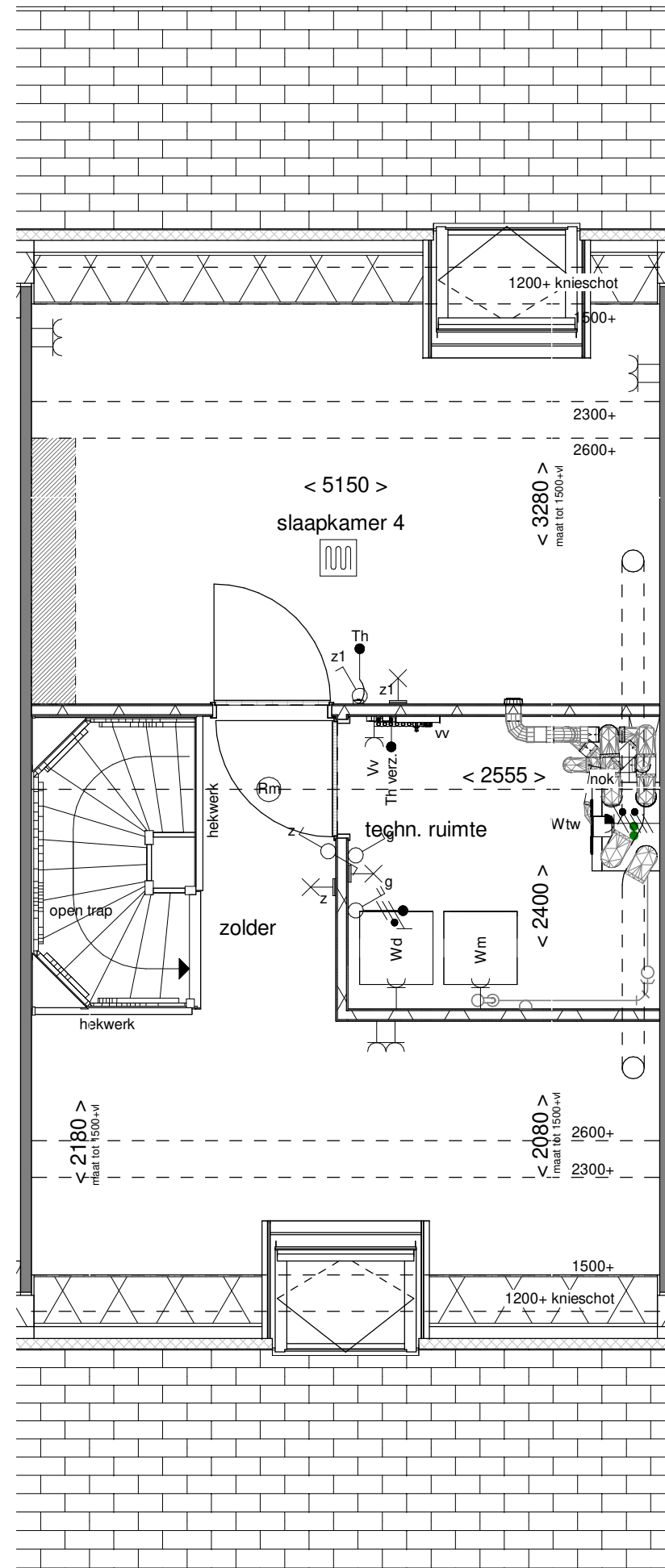

**ALLEMAAL
VIELEVAAL**

Tekening: Tweede verdieping

Woningtype: X+

Bouwnummer: 124

Bladnummer: VT-E4-124c

Schaal: 1:50

Datum: 27-10-2021

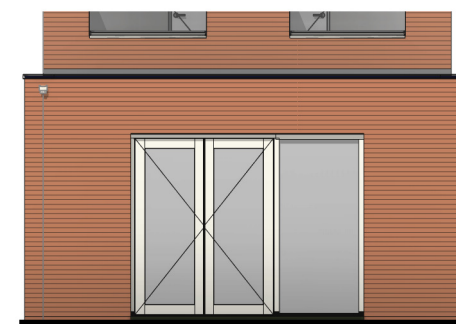
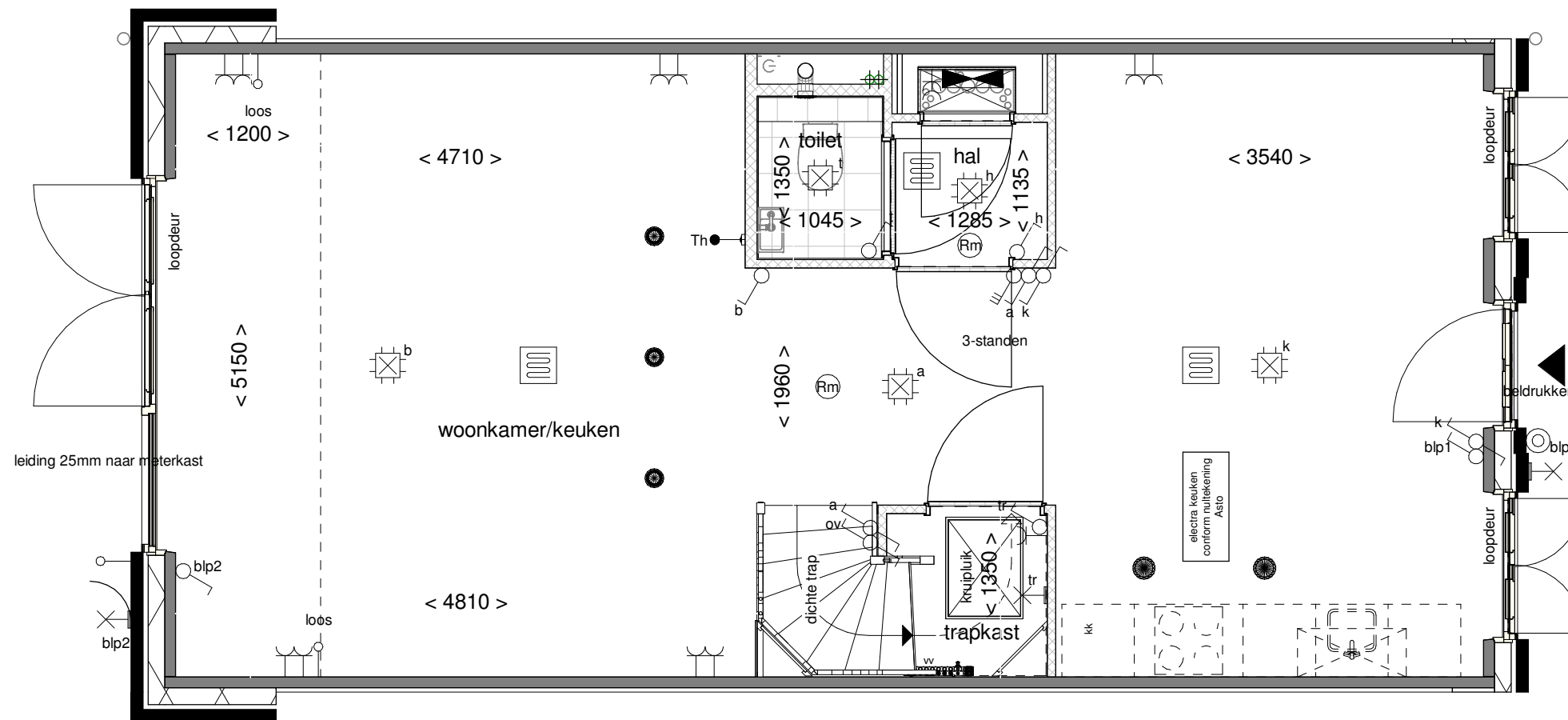

Achtergevel schaal 1:100

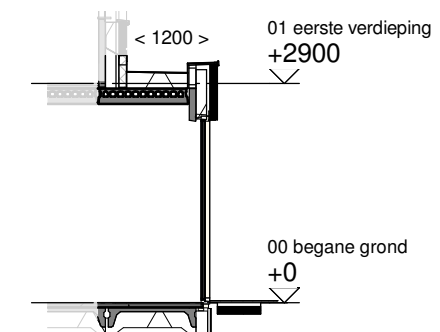

Doorsnede schaal 1:100

**ALLEMAAL
VIELEJAAL**

Optie: **Uitbouw achtergevel
1200mm**

Woningtype: **X54+**

Bouwnummer: -

Optienummer: **0.A.X.12**

Schaal: **1:50 / 1:100**

Datum: **29-09-2021**

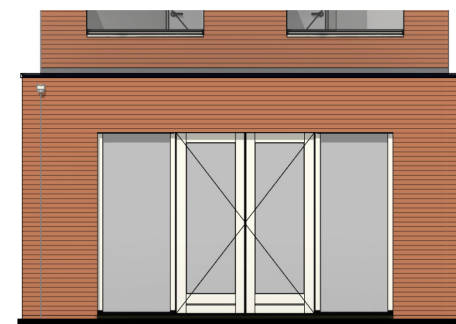
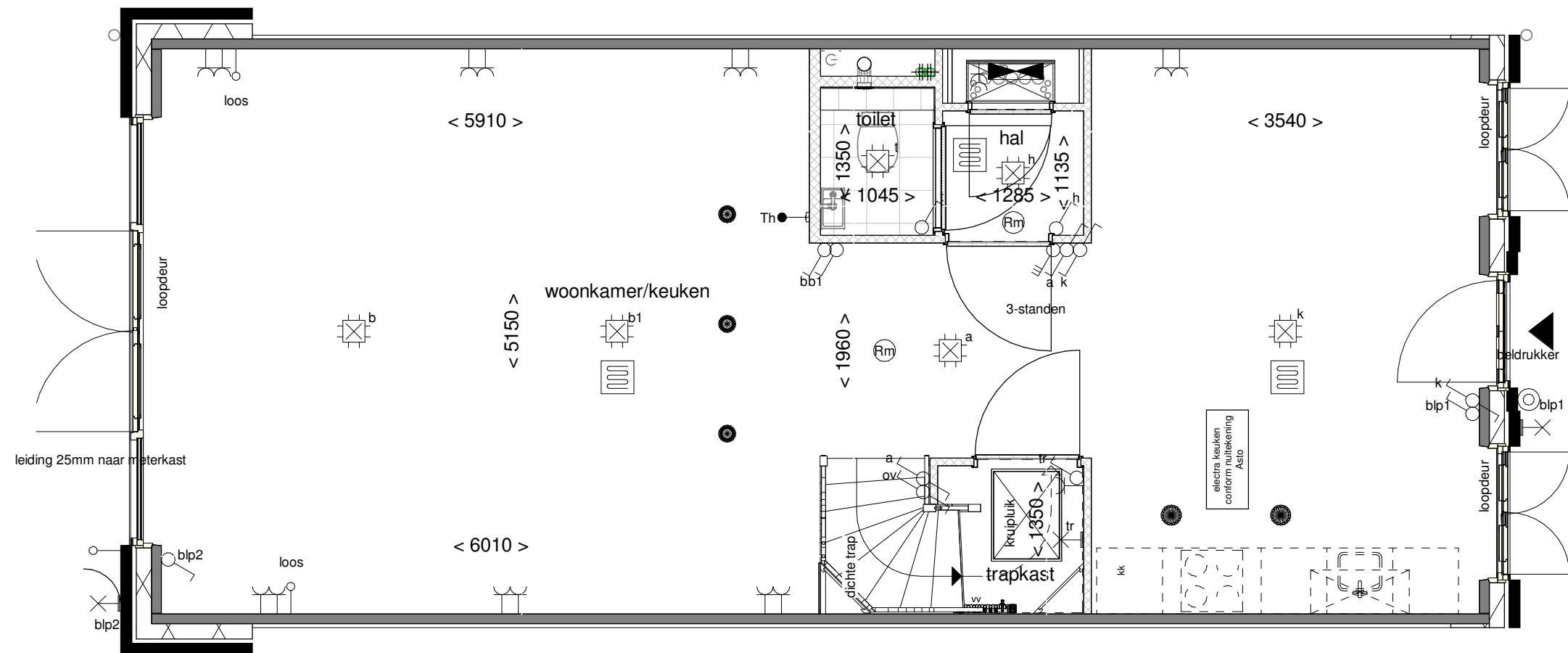

Achtergevel schaal 1:100

**ALLEMAAL
VIELEJAAL**

Optie: Dubbele deuren
achtergevel 3900mm

Woningtype: X54+

Bouwnummer: -

Optienummer: 1.A.X.62

Schaal: 1:50 / 1:100

Datum: 29-09-2021

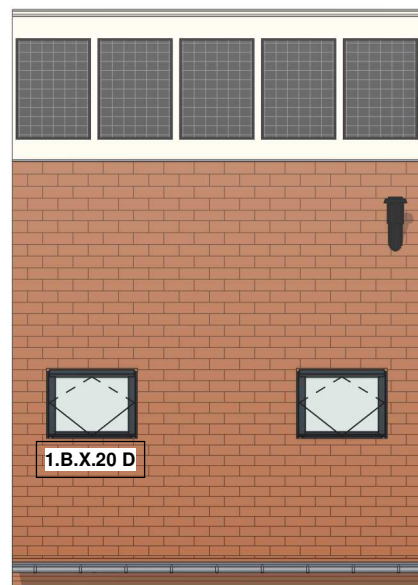
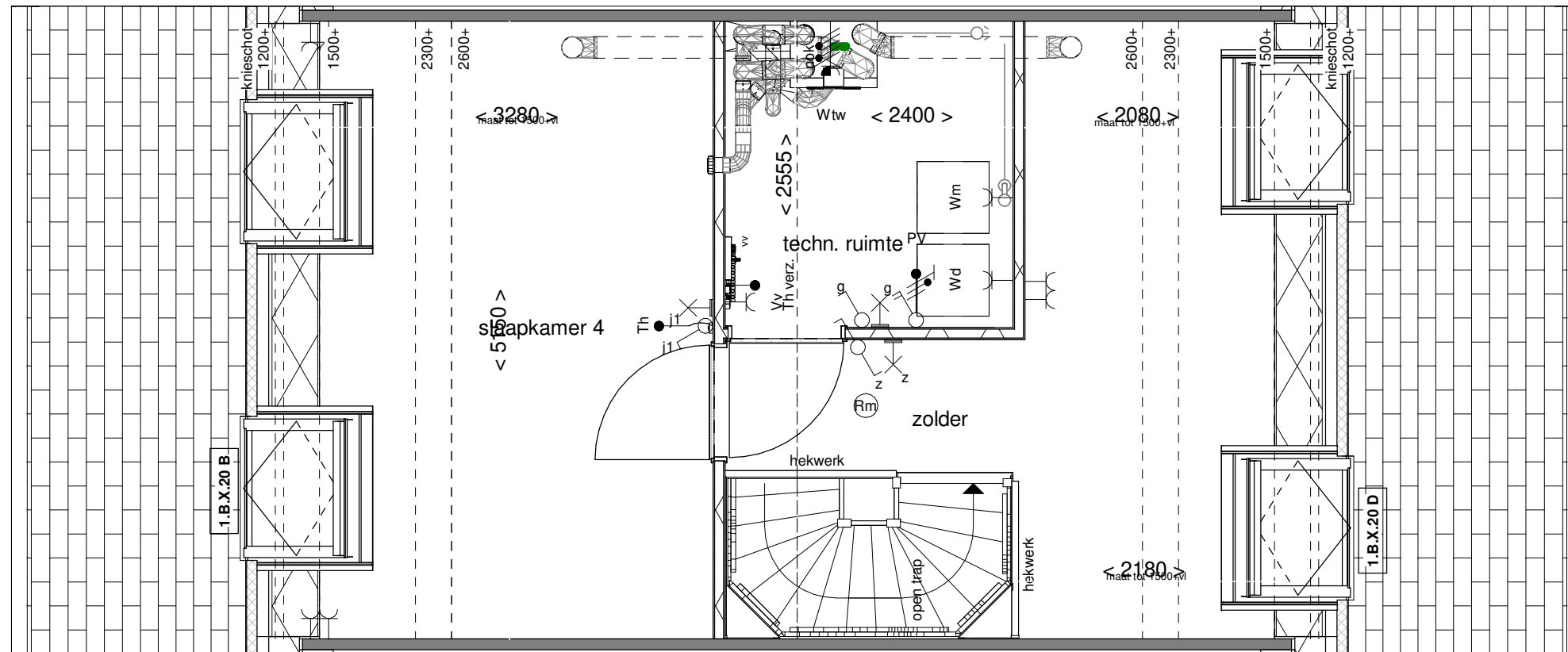

Voorgevel schaal 1:100

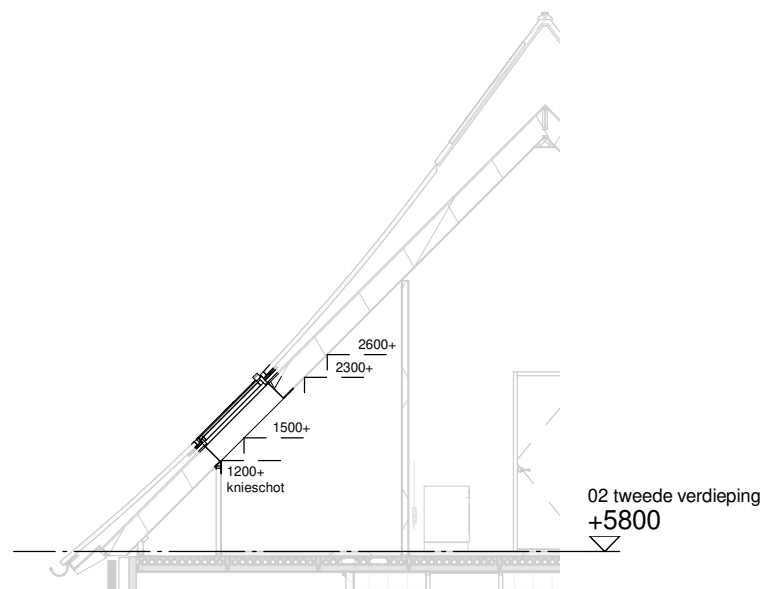

Doorsnede schaal 1:100

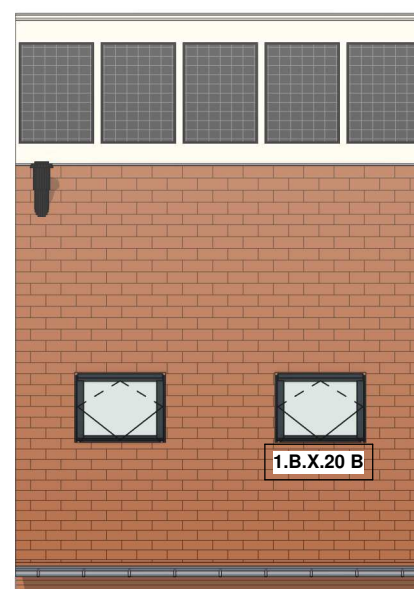

Achtergevel schaal 1:100

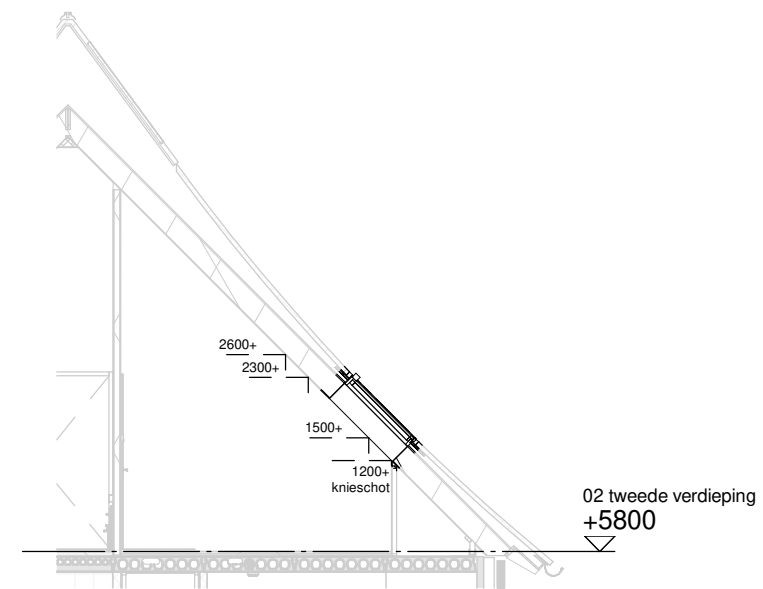

Doorsnede schaal 1:100

**ALLEMAAL
VIELEJAAL**

Optie: Dakramen voor- en achtergevel

Woningtype: X54+

Bouwnummer: -

Optienummer: 1.B.X.20

Schaal: 1:50 / 1:100

Datum: 29-09-2021

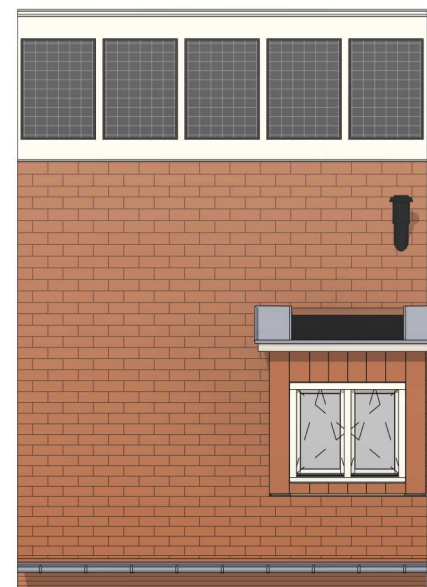
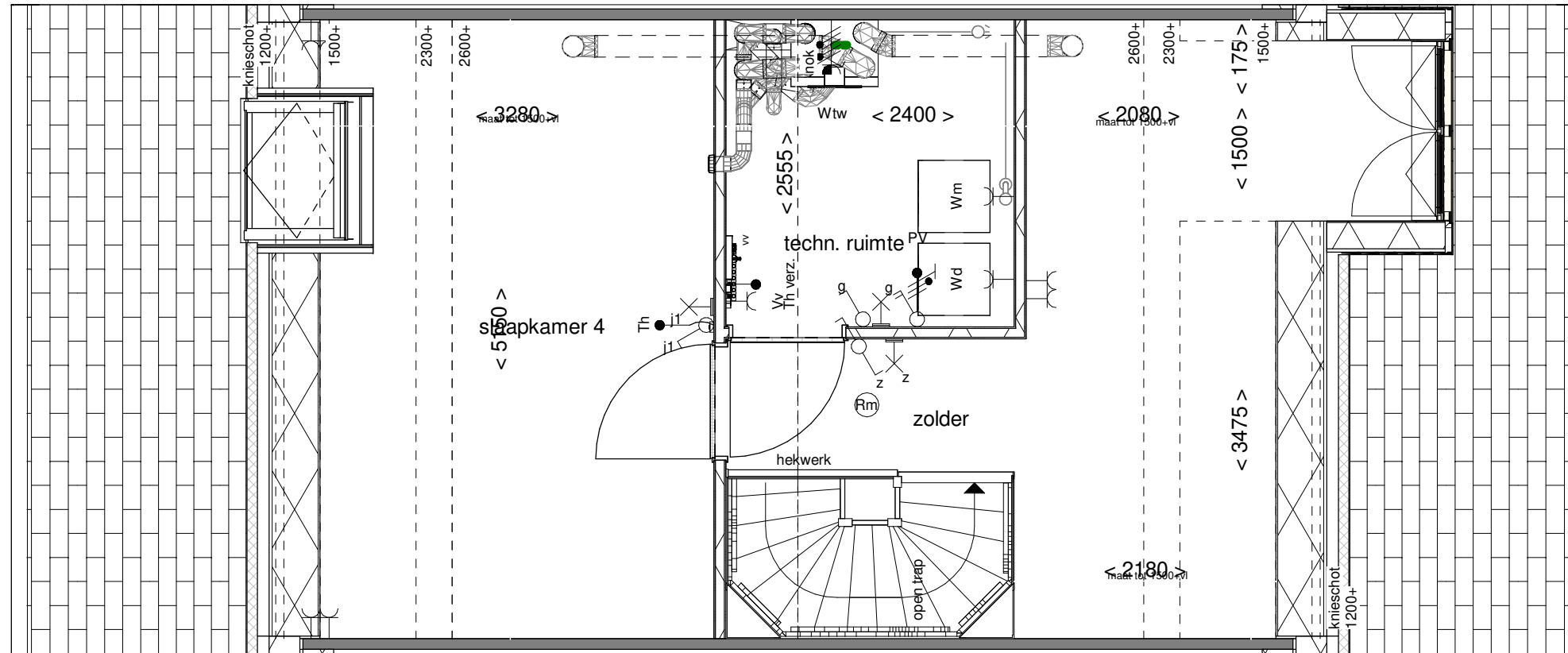

Achtergevel schaal 1:100

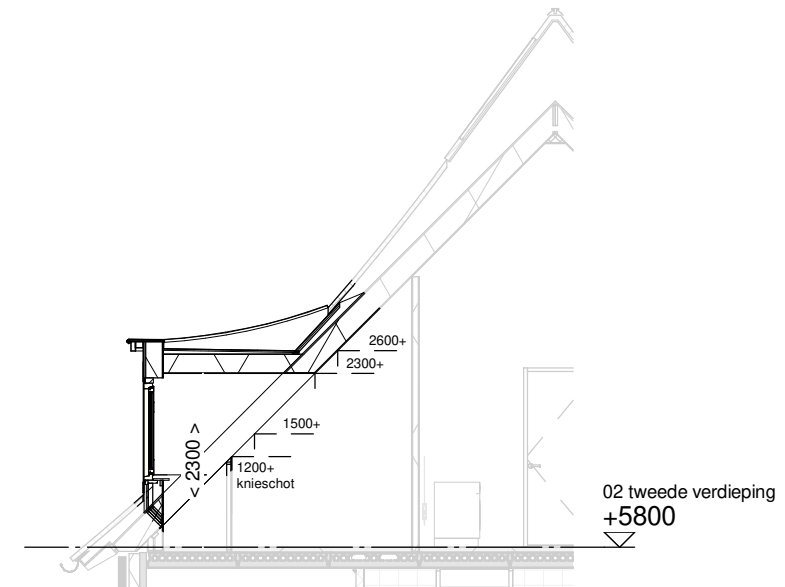

Doorsnede schaal 1:100

**ALLEMAAL
VIELEVAAL**

Optie: Dakkapel
voorgevel 1500mm

Woningtype: X54+

Bouwnummer: -

Optienummer: 1.B.X.33

Schaal: 1:50 / 1:100

Datum: 29-09-2021

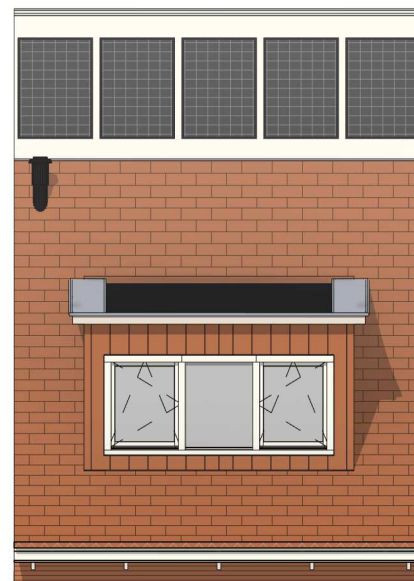
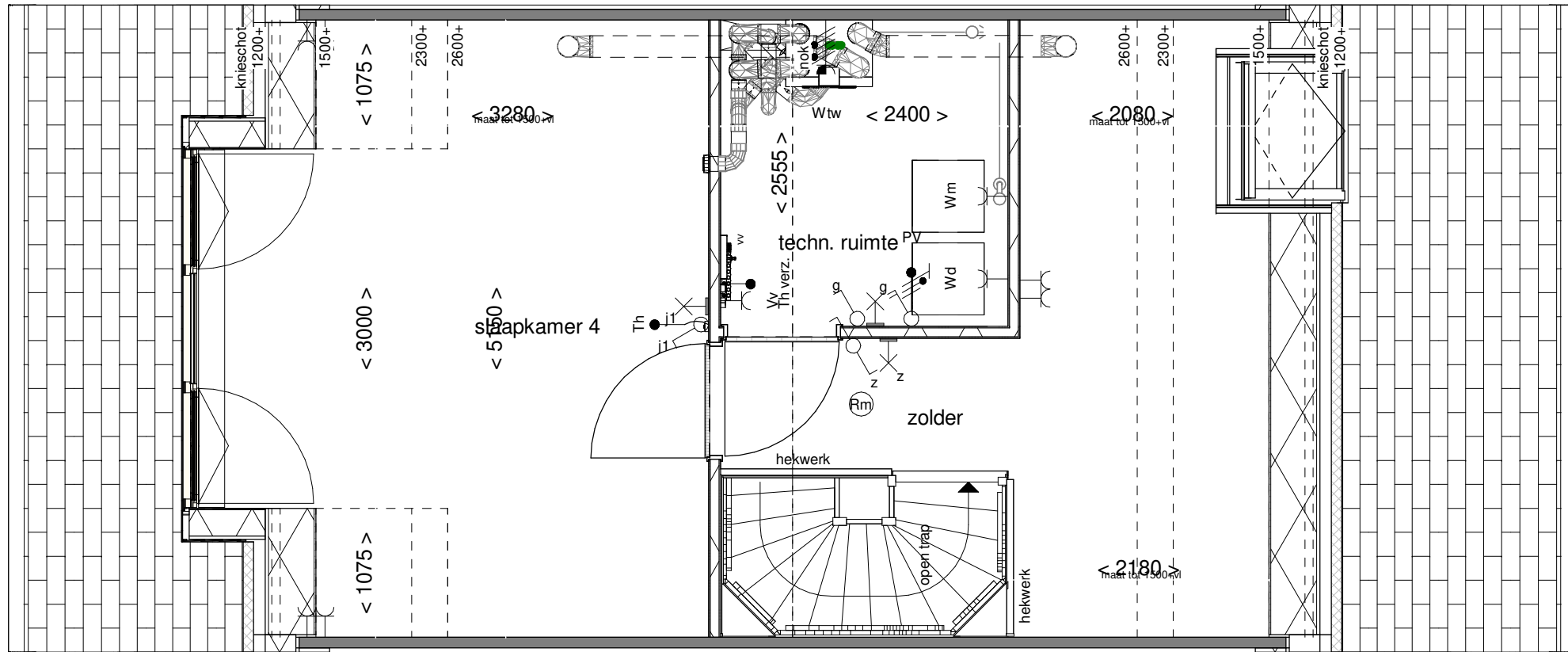

Achtergevel schaal 1:100

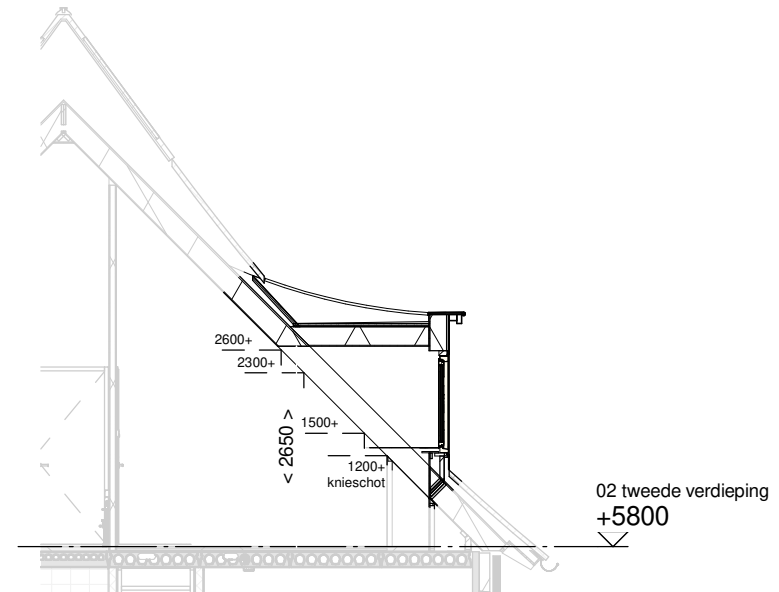

Doorsnede schaal 1:100

**ALLEMAAL
VIELEVAAL**

Optie: Dakkapel
achtergevel 3000mm

Woningtype: X54+

Bouwnummer: -

Optienummer: 1.B.X.34

Schaal: 1:50 / 1:100

Datum: 29-09-2021

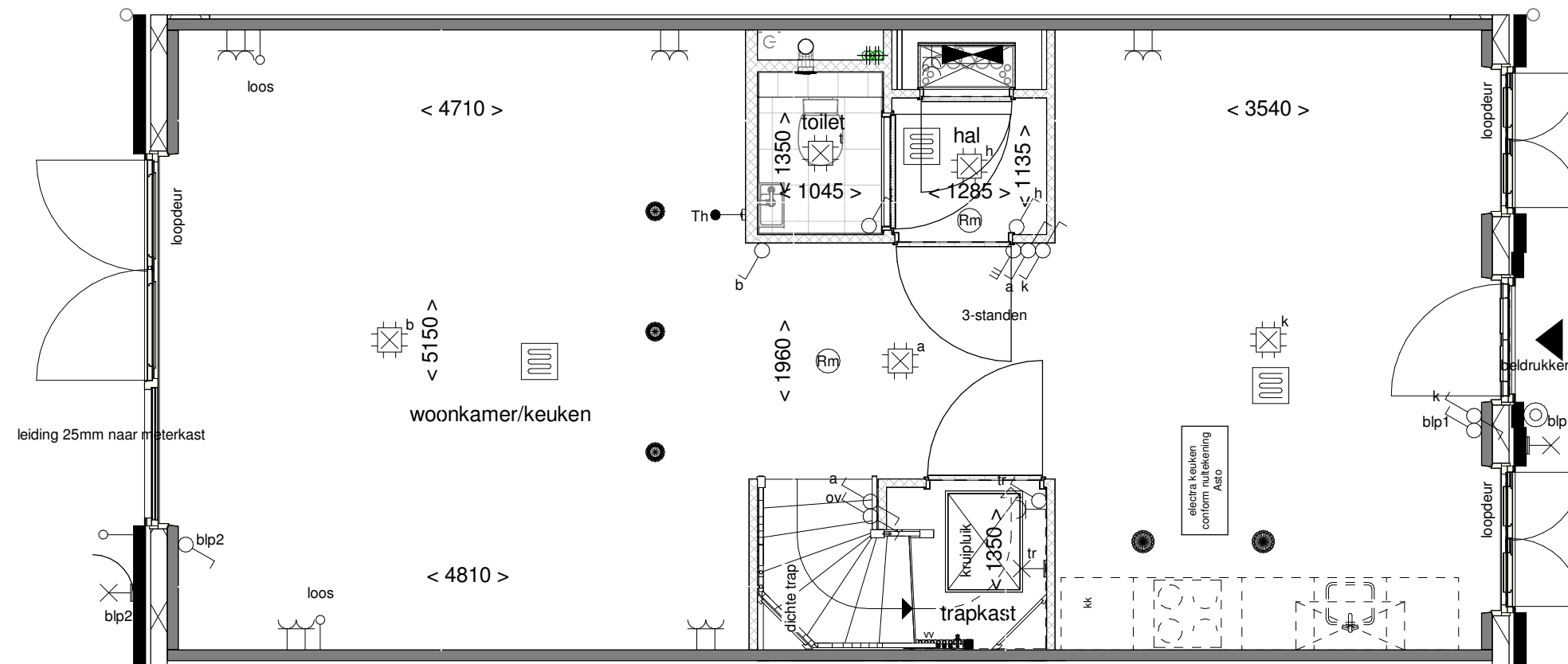

**ALLEMAAL
VIELEYAAL**

Optie: Trapkast

Woningtype: X54+

Bouwnummer: -

Optienummer: 1.C.X.10

Schaal: 1:50

Datum: 29-09-2021

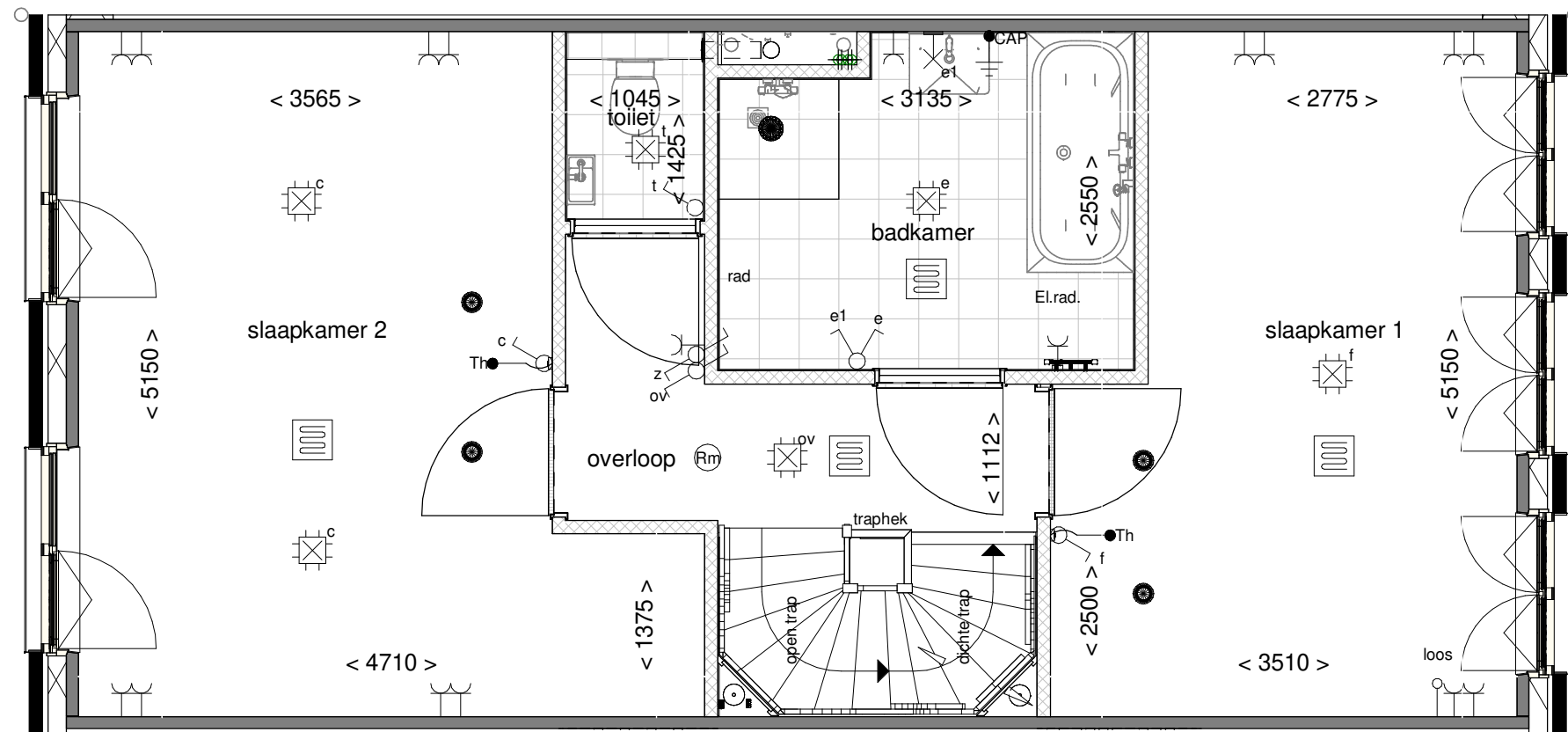

**ALLEMAAL
YIELEYAAL**

Optie: Samenvoegen
slaapkamer 2 en 3

Woningtype: X54+

Bouwnummer: -

Optienummer: 1.C.X.30

Schaal: 1:50

Datum: 29-09-2021

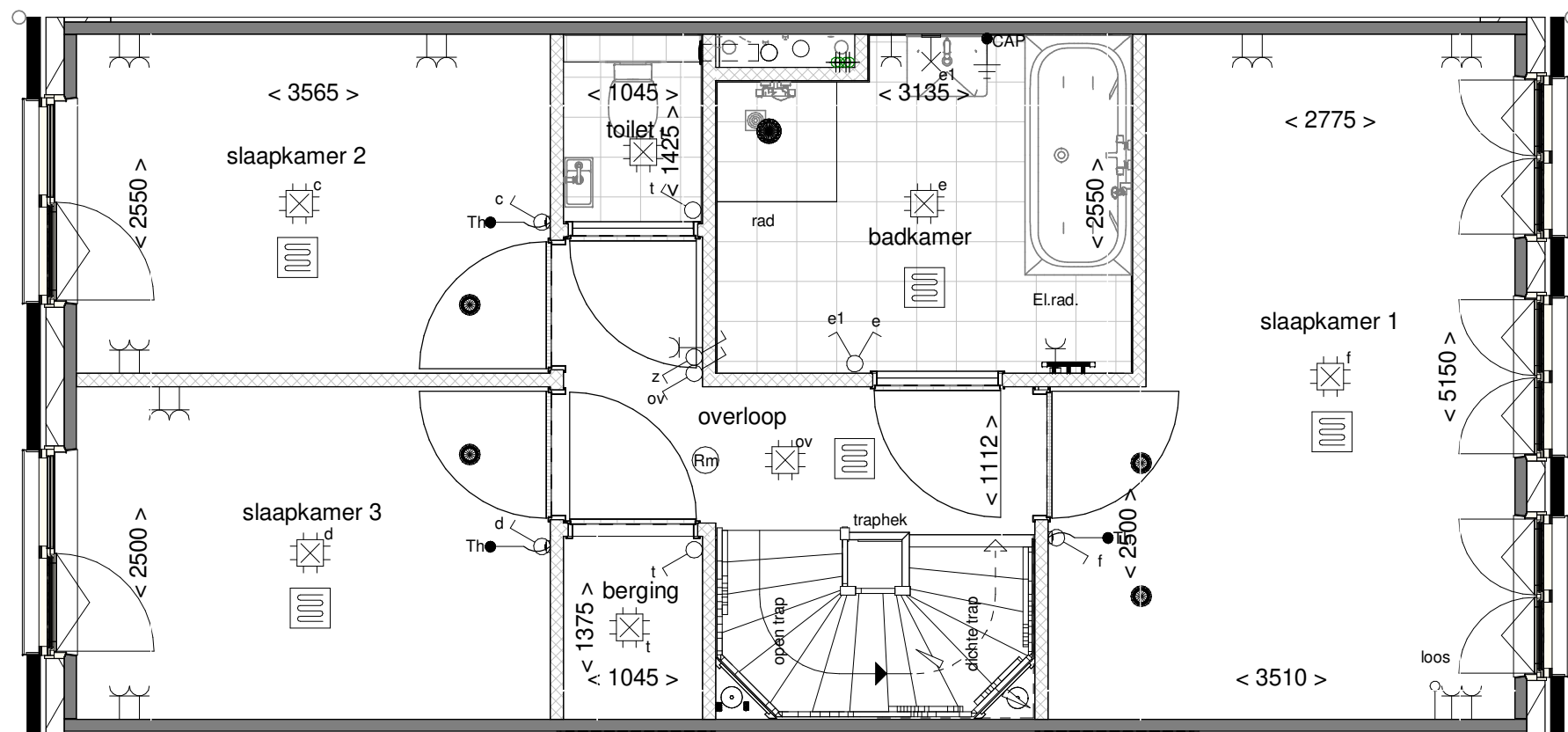

**ALLEMAAL
VIELEJAAR**

Optie: Kast op overloop

Woningtype: X54+

Bouwnummer: -

Optienummer: 1.C.X.34

Schaal: 1:50

Datum: 29-09-2021

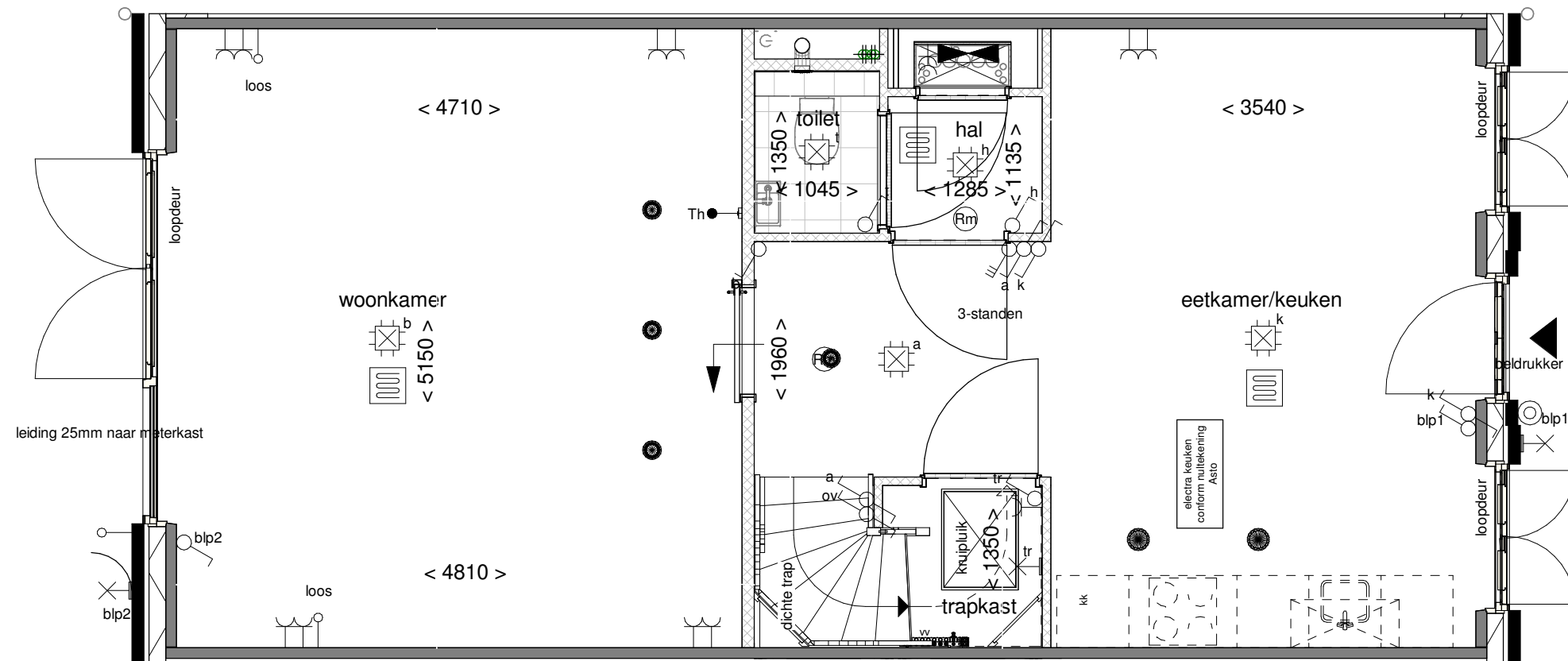

**ALLEMAAL
WIELEYAAL**

Optie: Schuifdeur tussen woonk. en keuken

Woningtype: X54+

Bouwnummer: -

Optienummer: 1.C.X.42

Schaal: 1:50

Datum: 29-09-2021

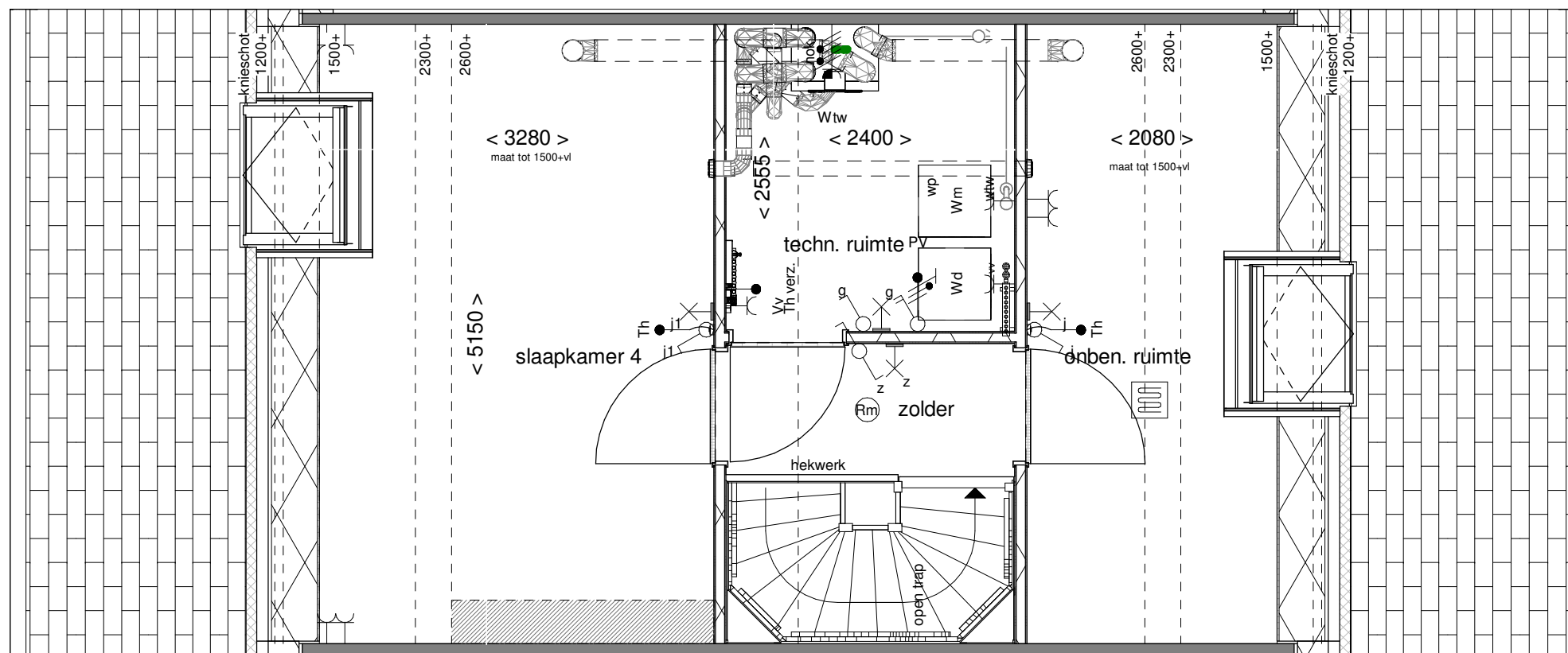

**ALLEMAAL
VIELEJAAL**

Optie: Techn.- en onben.
ruimte en slaapkamer

Woningtype: X54+

Bouwnummer: -

Optienummer: 1.C.X.78

Schaal: 1:50

Datum: 29-09-2021