

**ALLEMAAL  
YIELEYAAL**

Tekening: **Situatie totaal**

Woningtype:

Bouwnummer:

Bladnummer: **VT-S-01**

Schaal: **1:1000**

Datum: **27-10-2021**

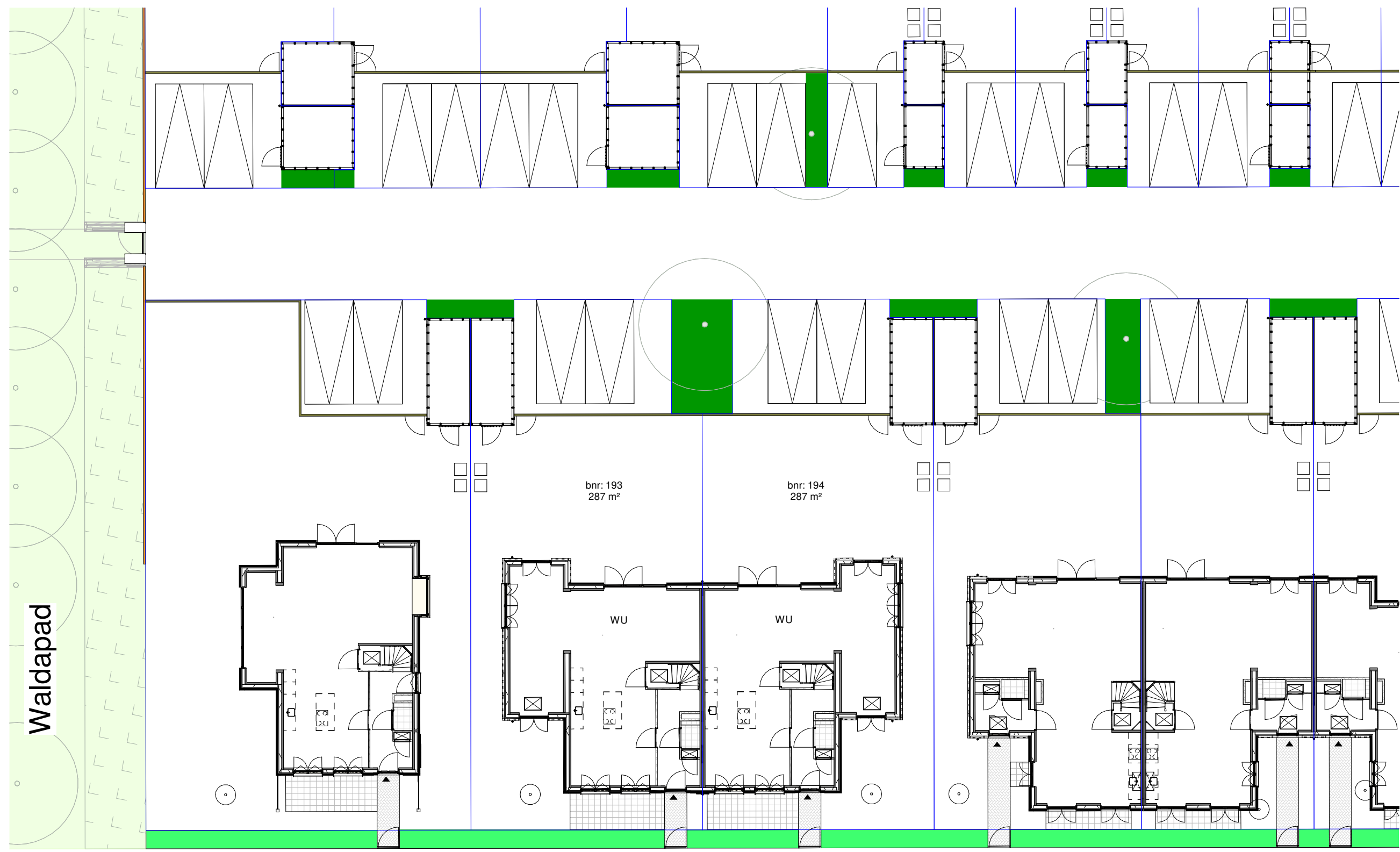

- ### Renvooi
-  - entree woning
  -  - parkeervak eigen terrein
  -  - erfgrans
  -  - beplanting type n.t.b. koper
  -  - opstelplaats kliko
  -  - tuinhekje
  -  - klinkerbestrating
  -  - betontegels 300x300mm
  -  - groen strook
  -  - haag h=900mm
  -  - haag h=1800mm
  -  - bamboehok h=1800mm
  -  - gaashek met klimplanten en poort h=1600mm
- parkeerplekken en posities bomen en struiken zijn indicatief**

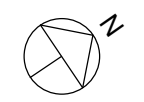

Waldapad

bnr: 193  
287 m<sup>2</sup>

bnr: 194  
287 m<sup>2</sup>

WU

WU

**ALLEMAAL  
YIELEYAAL**

Warmoldstraat

Tekening: Situatie Blok I5

---

Woningtype: WU

---

Bouwnummer: 193-194

---

Bladnummer: VT-S-18











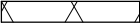

---

Schaal: 1:200



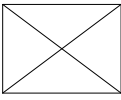

























---

Datum: 27-10-2021

## Renvooi bouwkundig

	metselwerk kleur A
	dakpannen kleur oranje
	entree woning
	metselwerk
	isolatie
	dragende wand
	niet dragende binnenwand
	binnendeurkozijn (met bovenlicht)
	kruipluik
	opstelplaats wasmachine
	opstelplaats wasdroger
	
	principe opstelling keukenblok

## Renvooi installaties

	aansluitpunt licht
	aansluitpunt licht, wand
	centraaldoos met lichtpunt
	armatuur aan de wand
	rookmelder
	aansluitpunt niet bedraad
	verdeelinrichting / meterkast / groepenkast
	beldrukker
	schel
	schakelaar, 1-polig
	werkschakelaar tbv PV-panelen
	schakelaar, 3-polig
	schakelaar, wissel
	schakelaar, kruis
	schakelaar, serie
	wandcontactdoos 1-voudig met beschermingscontact
	wandcontactdoos 2-voudig met beschermingscontact, verticaal
	wandcontactdoos 2-voudig met beschermingscontact
	thermostaatleiding, bedraad
	mechanische ventilatie-unit incl. warmteterugwinunit
	warmtepomp
	inblaasventiel mechanische ventilatie
	uitblaasventiel mechanische ventilatie
	verdeler vloerverwarming
	ruimte voorzien van vloerverwarming
	elektrische radiator
	kanalen in het zicht
	onbenoemde ruimte volgens krijstreepmethode

### Disclaimer

De op deze tekeningen aangegeven maten zijn circa maten in millimeters en tussen de wanden / vloeren gemeten, waarbij geen rekening is gehouden met enige wandafwerking, plinten, aftimmering, ect. In verband met de nauwkeurige uitwerking van details, constructie, maatvoering, materialen e.d. kunnen er kleine afwijkingen ontstaan ten opzichte van de nu vermelde gegevens. Deze geringe afwijkingen geven geen aanleiding tot verrekening. Aan de op deze tekening aangegeven maten kunnen derhalve geen rechten worden ontleend. De op deze tekeningen aangegeven maatvoering is niet geschikt voor opdrachten aan derden door koper(s). De posities van aansluitingen en installatie onderdelen zijn indicatief op tekening aangegeven. De exacte aantallen en posities zullen na berekening in het werk door de installateurs worden bepaald en kunnen afwijken van deze tekening.

**ALLEMAAL  
YIELEYAAL**

Tekening: Renvooi

Woningtype: -

Bouwnummer: -

Bladnummer: VT-0-00c

Schaal: -

Datum: 27-10-2021



Type: WU  
bwnr: 193

Type: WU  
bwnr: 194



Type: WU  
bwnr: 194

Type: WU  
bwnr: 193

ALLEMAAL  
YIELEYAAL

Tekening: Gevels blok I5

Woningtype: W-U

Bouwnummer: 193 t/m 194

Bladnummer: VT-I5-00a

Schaal: 1:150

Datum: 27-10-2021



Type: W-U  
Bouwnummer: 193

Linker zijgevel



Type: W-U  
Bouwnummer: 194

Rechter zijgevel

**ALLEMAAL  
YIELEYAAL**

Tekening: Zijgevels blok I5

Woningtype: W-U

Bouwnummer: 193 t/m 194

Bladnummer: VT-I5-00b

Schaal: 1:100

Datum: 27-10-2021

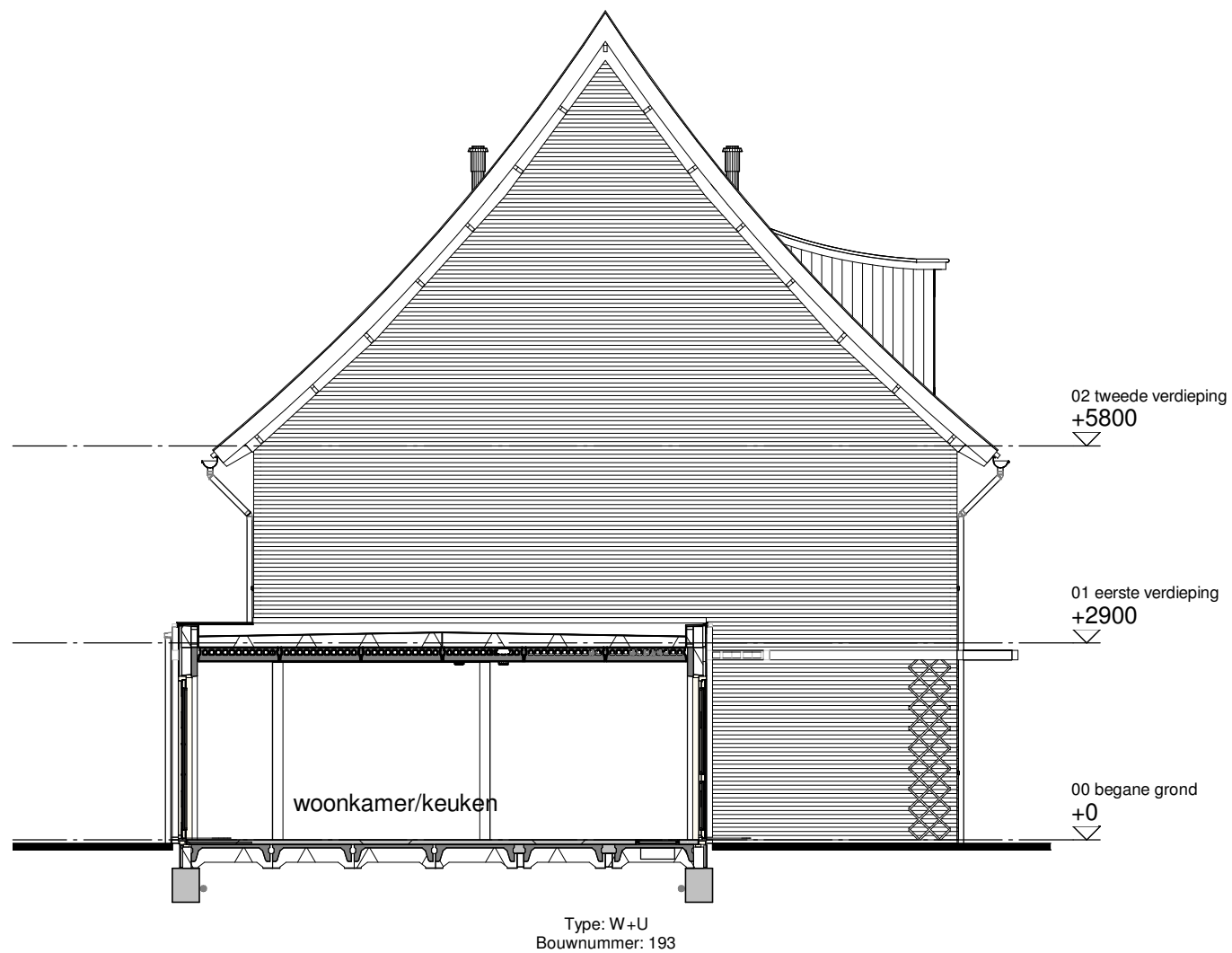

Doorsnede A

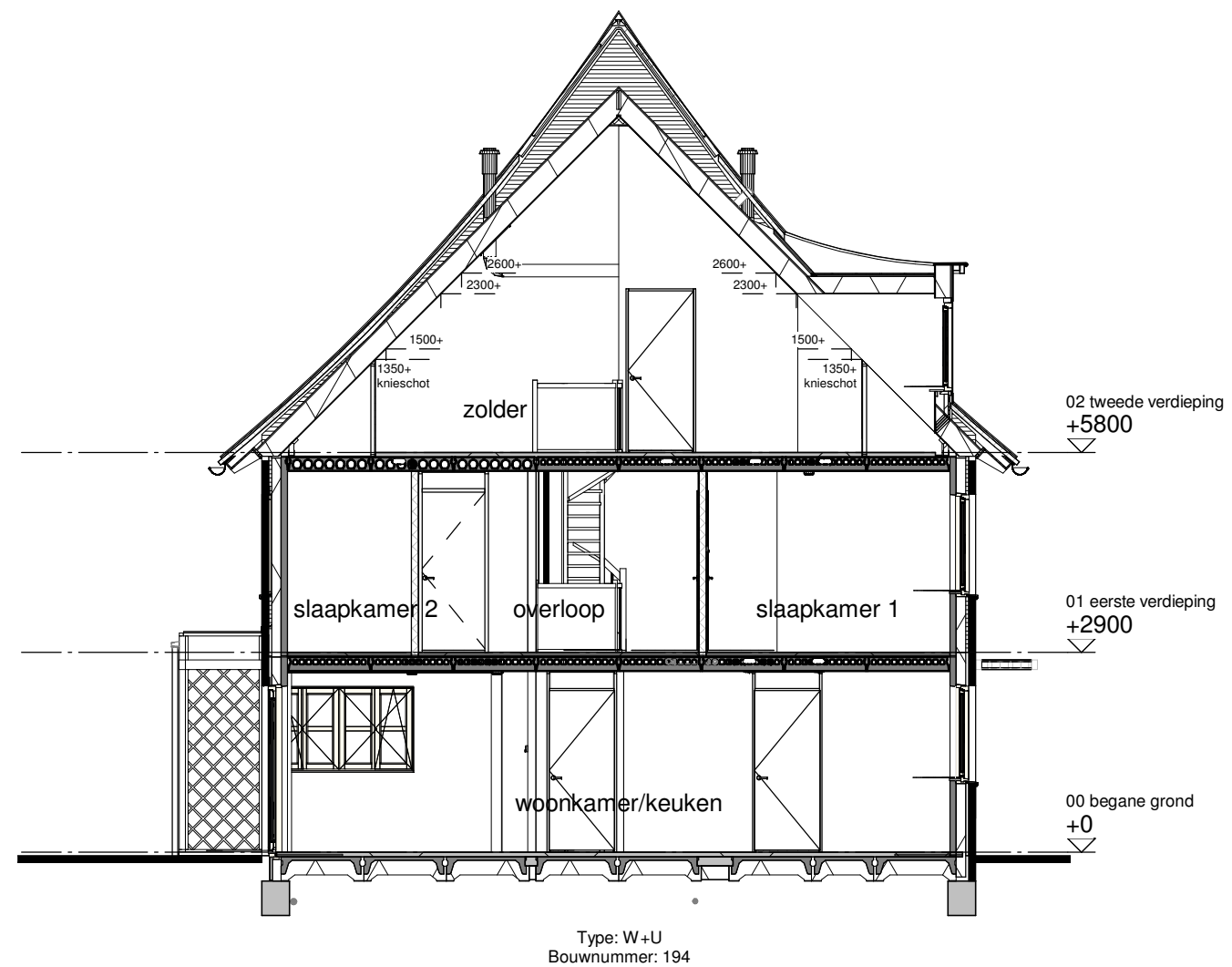

Doorsnede B

**ALLEMAAL  
VIELEYAAL**

Tekening: Doorsneden blok I5

Woningtype: W-U

Bouwnummer: 193-194

Bladnummer: VT-I5-00c

Schaal: 1:100

Datum: 27-10-2021

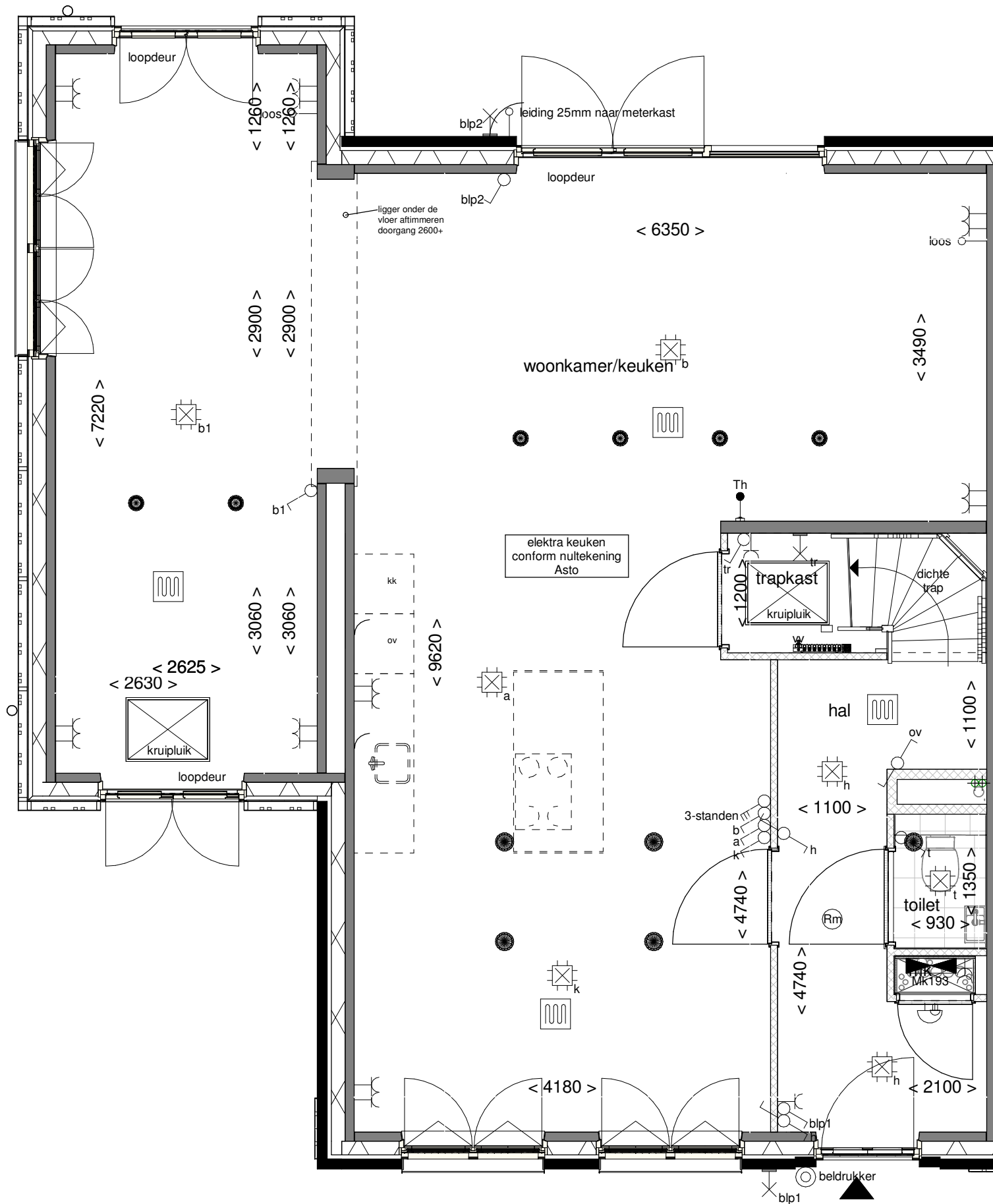

**ALLEMAAL  
VIELEVAAL**

Tekening: Begane grond

Woningtype: W-U

Bouwnummer: 193

Bladnummer: VT-I5-193a

Schaal: 1:50

Datum: 27-10-2021

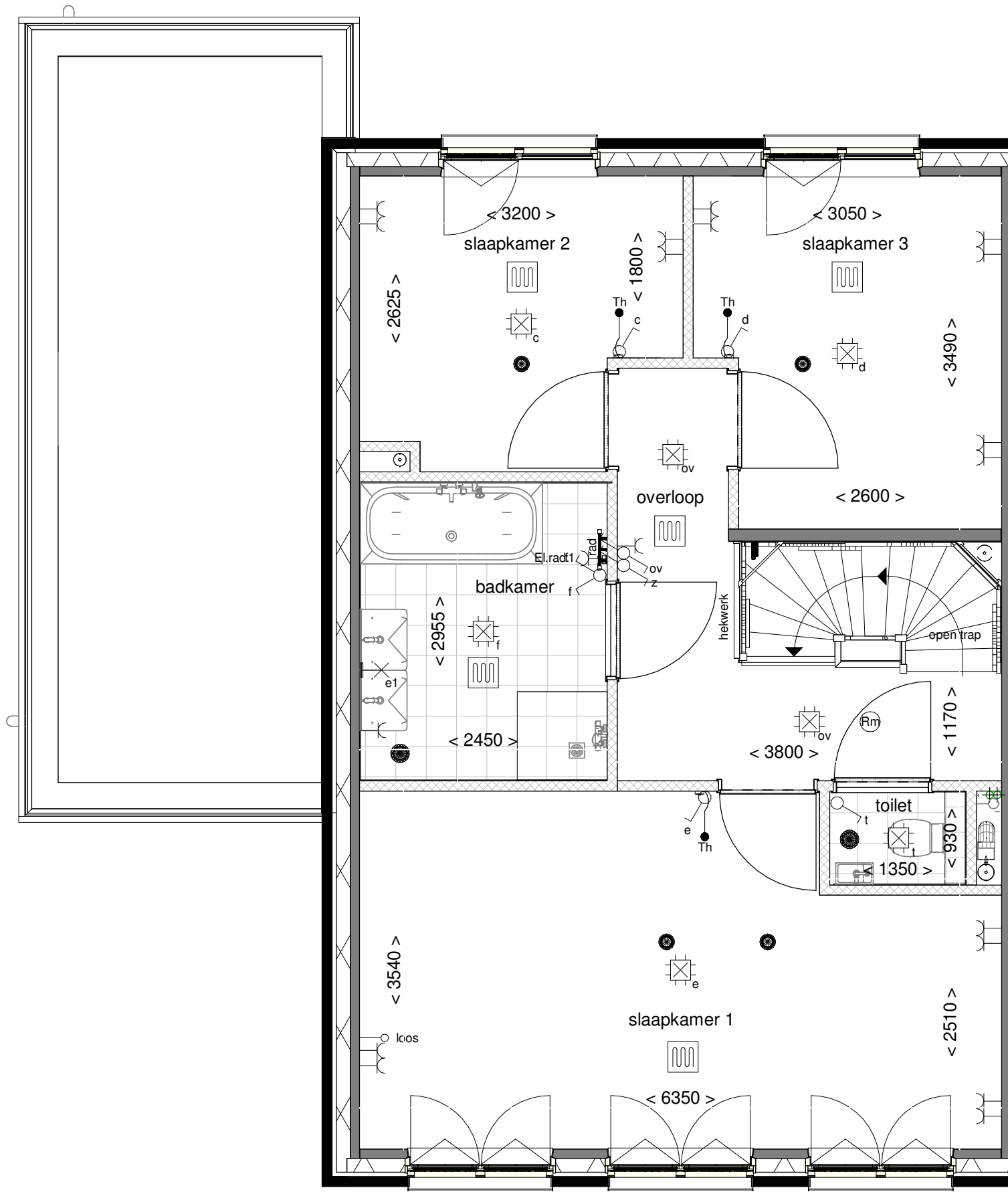

**ALLEMAAL  
VIELEYAAL**

Tekening: Eerste verdieping

Woningtype: W-U

Bouwnummer: 193

Bladnummer: VT-15-193b

Schaal: 1:50

Datum: 27-10-2021



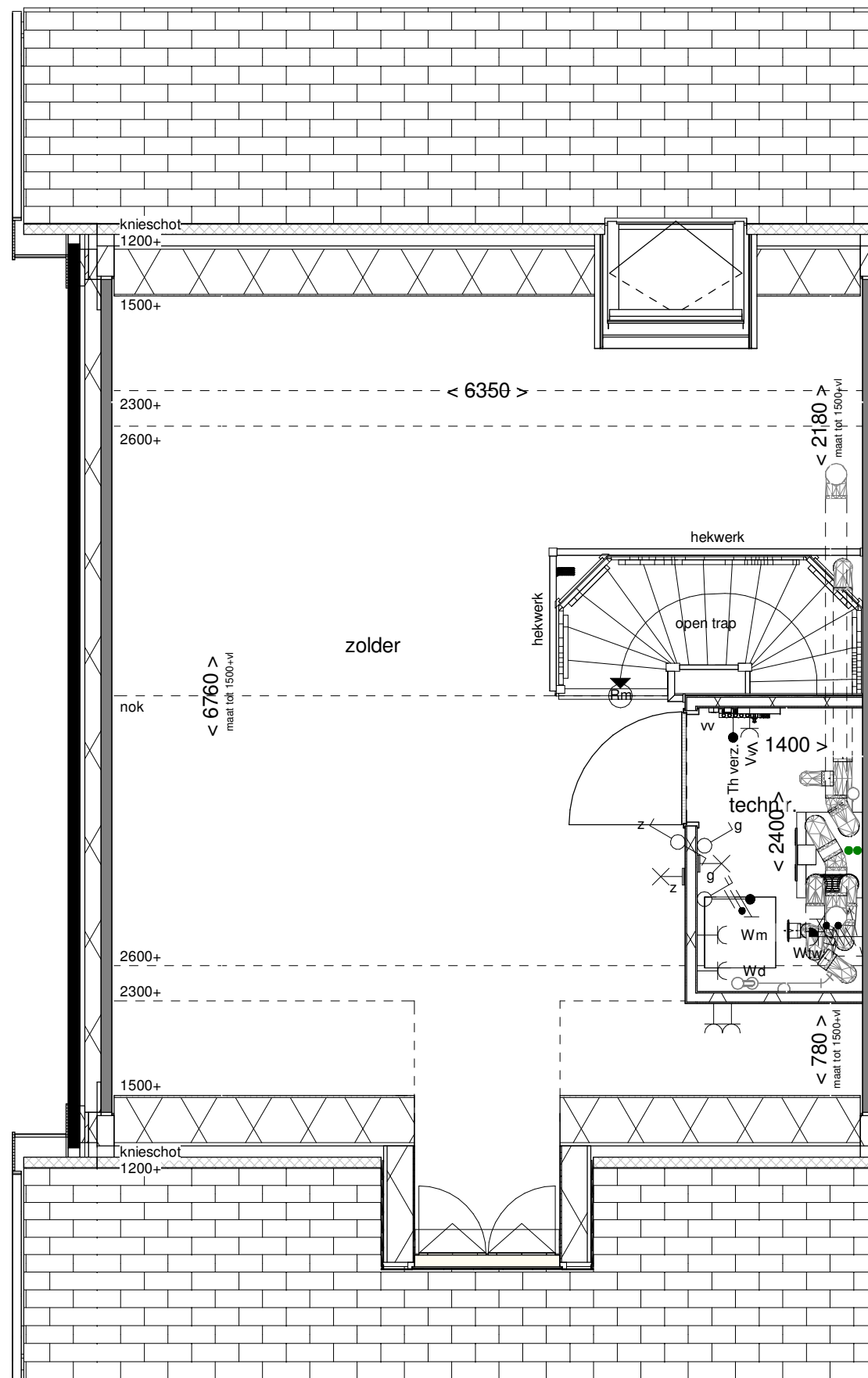

**ALLEMAAL  
VIELEJAAL**

Tekening: Tweede verdieping

Woningtype: W-U

Bouwnummer: 193

Bladnummer: VT-I5-193c

Schaal: 1:50

Datum: 27-10-2021

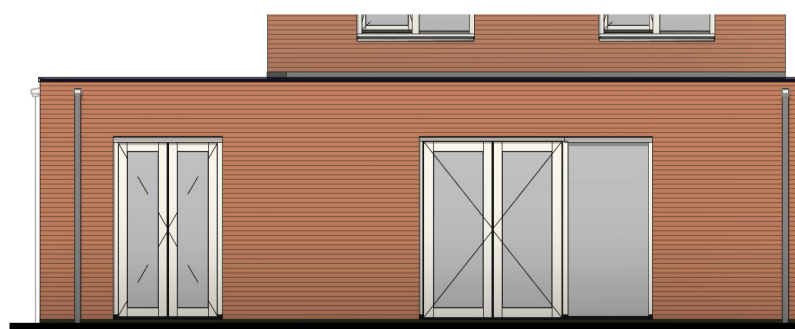
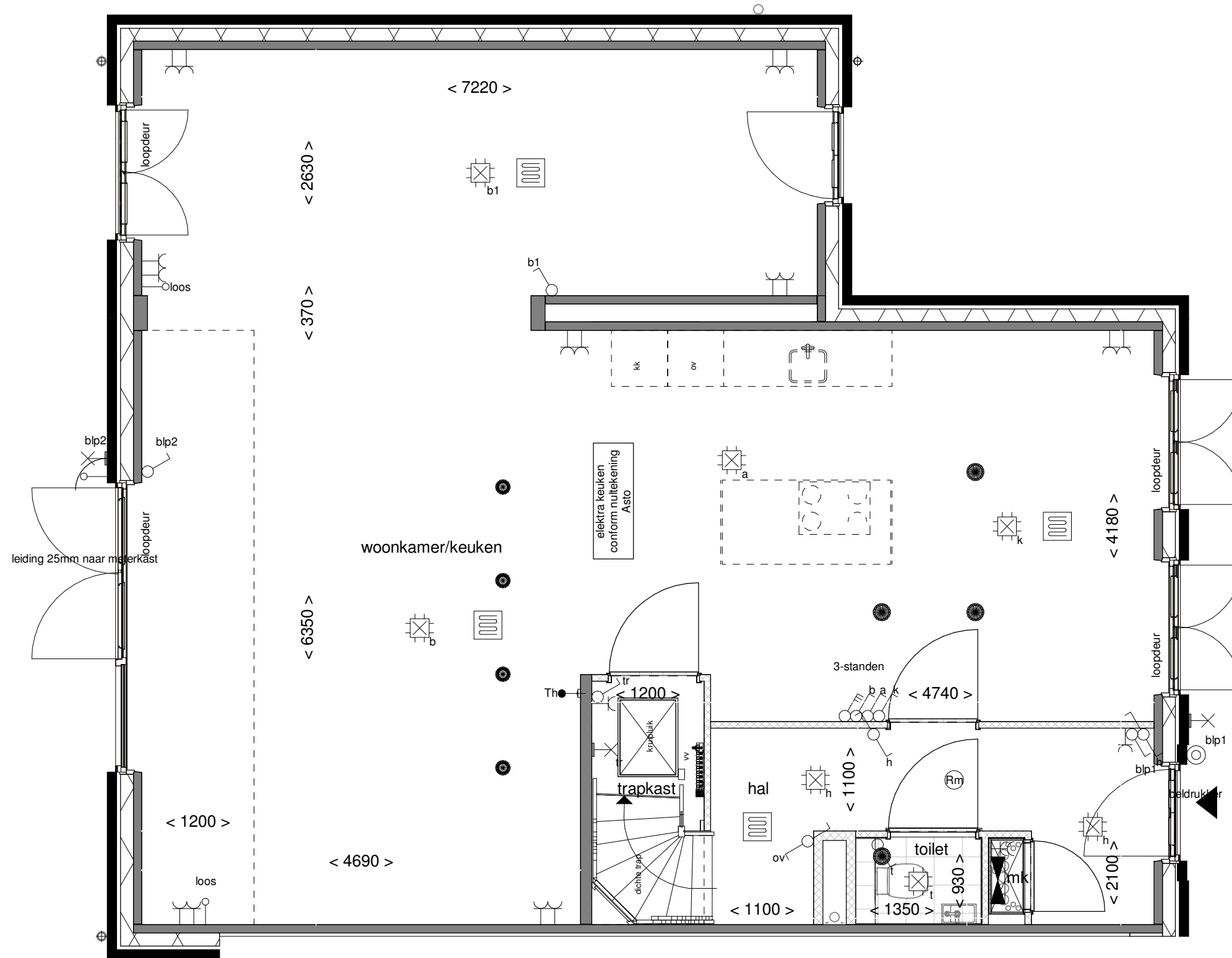

Achtergevel schaal 1:100

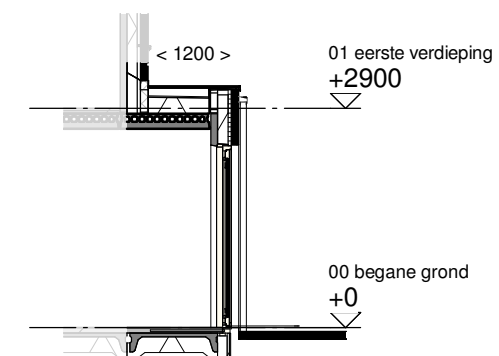

Doorsnede schaal 1:100

**ALLEMAAL  
YIELEYAAL**

Optie: **Uitbouw achtergevel  
1200mm**

Woningtype: **W66U**

Bouwnummer: -

Optienummer: **0.A.W.12**

Schaal: **1:50 / 1:100**

Datum: **27-10-2021**

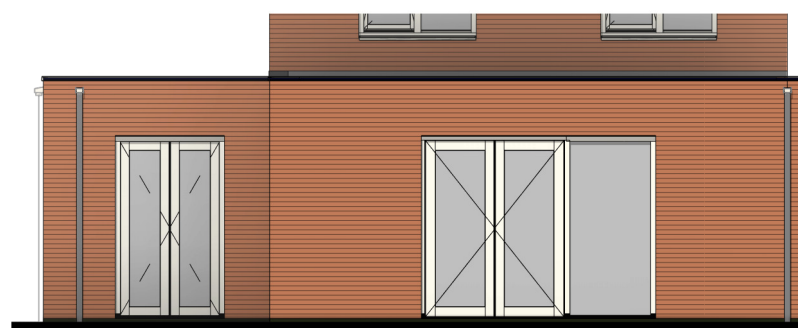
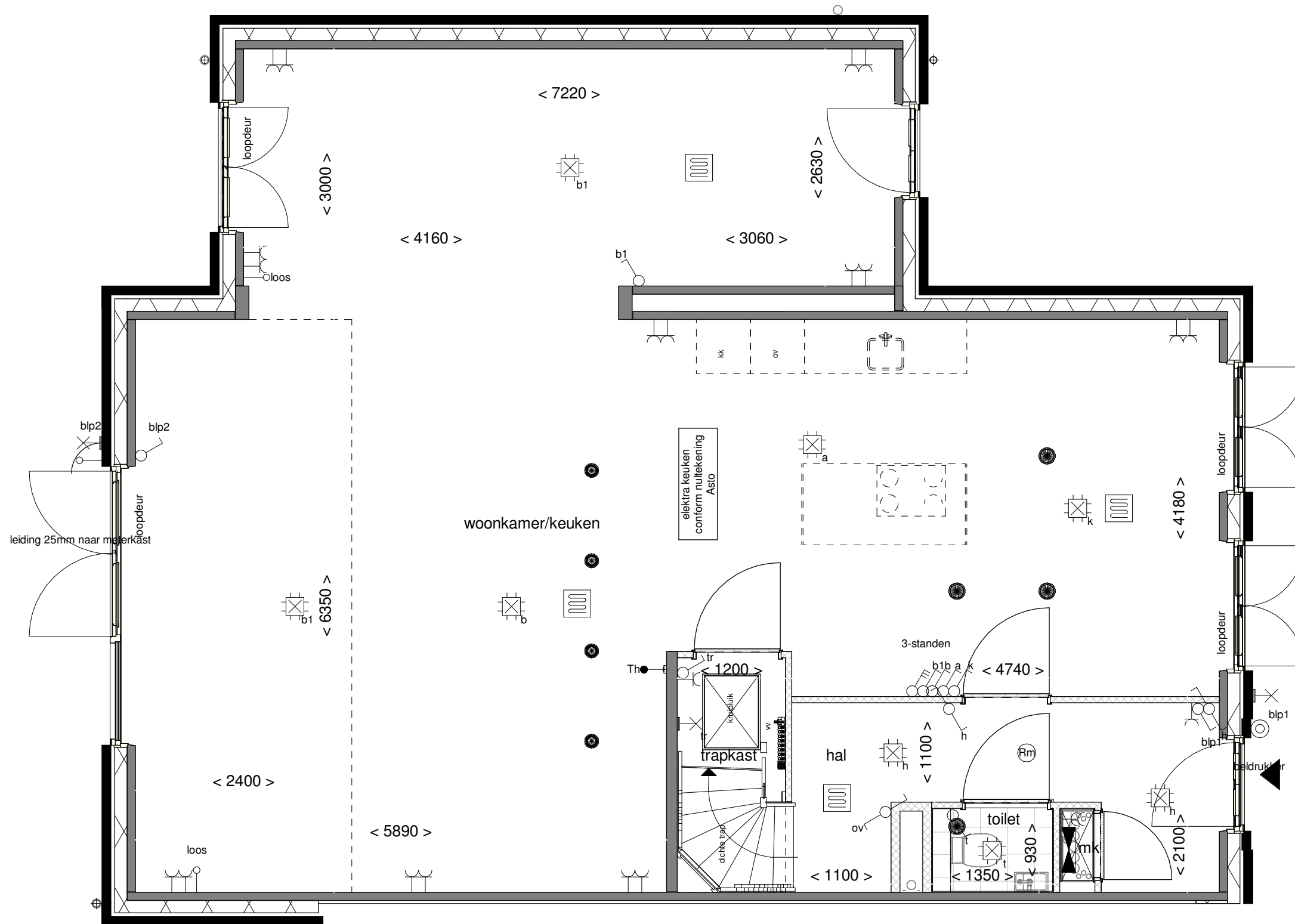

Achtergevel schaal 1:100

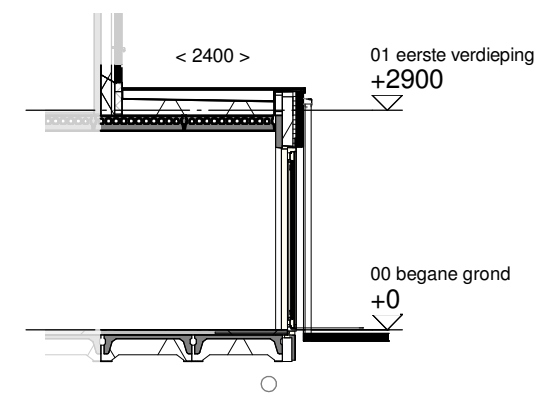

Doorsnede schaal 1:100

**ALLEMAAL  
YIELEYAAL**

Optie: **Uitbouw achtergevel  
2400mm**

Woningtype: **W66U**

Bouwnummer: -

Optienummer: **0.A.W.32**

Schaal: **1:50 / 1:100**

Datum: **27-10-2021**

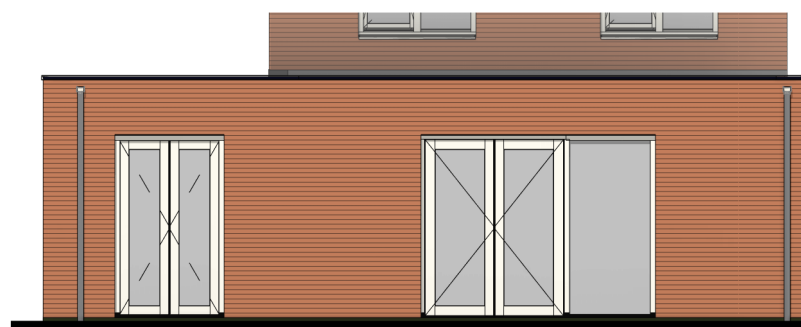
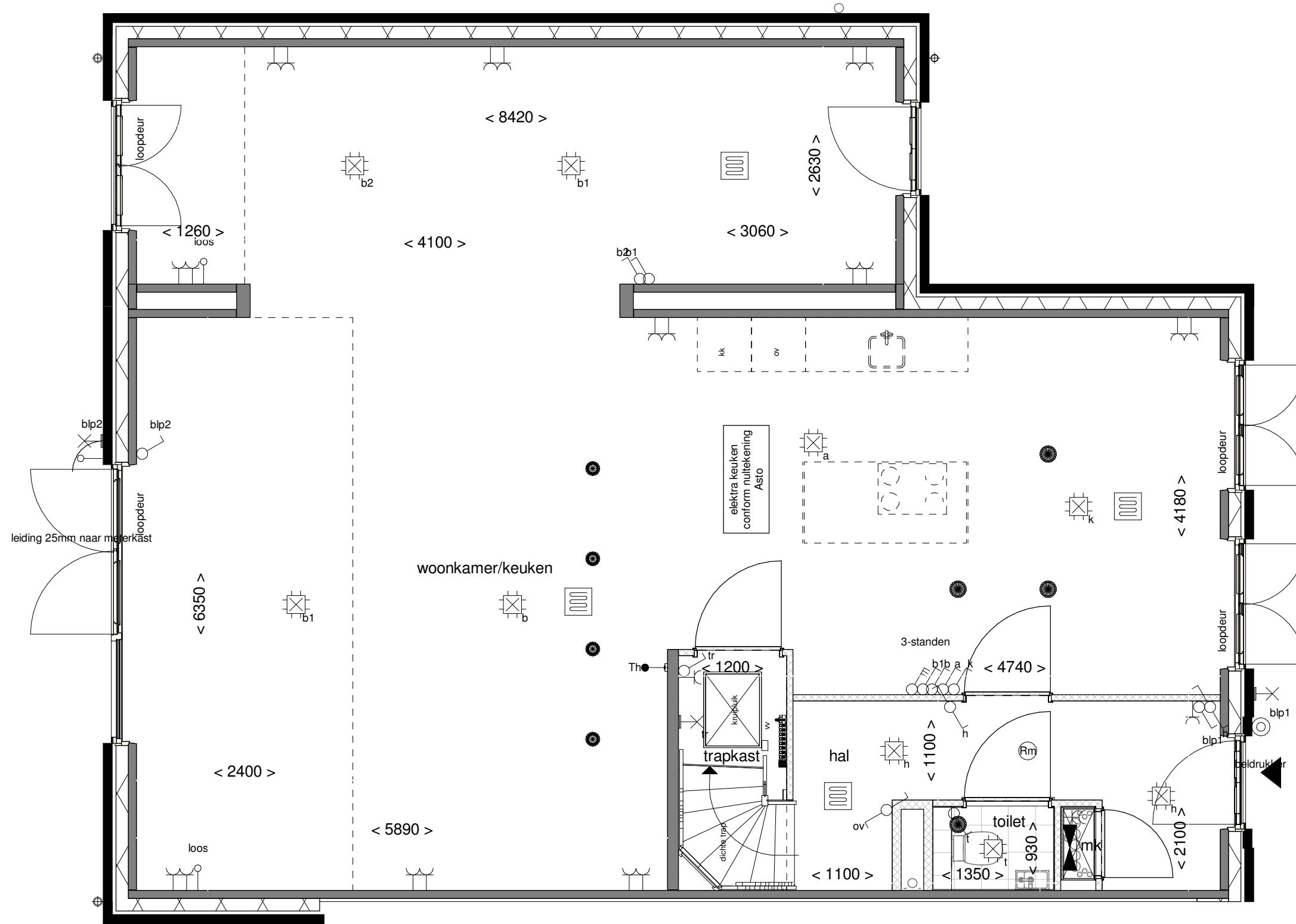

Achtergevel schaal 1:100

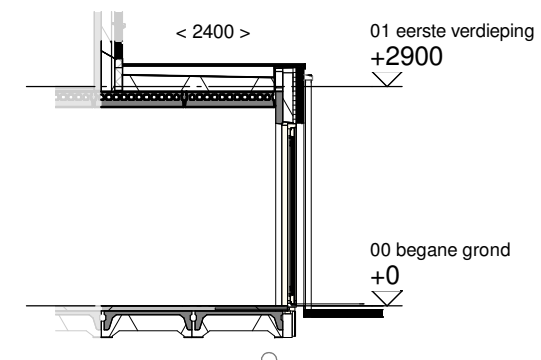

Doorsnede schaal 1:100

**ALLEMAAL  
YIELEYAAL**

Optie: **Uitb. achter 2400mm  
+ zijuitbouw 1200mm**

Woningtype: **W66U**

Bouwnummer: -

Optienummer: **0.A.W.52**

Schaal: **1:50 / 1:100**

Datum: **27-10-2021**

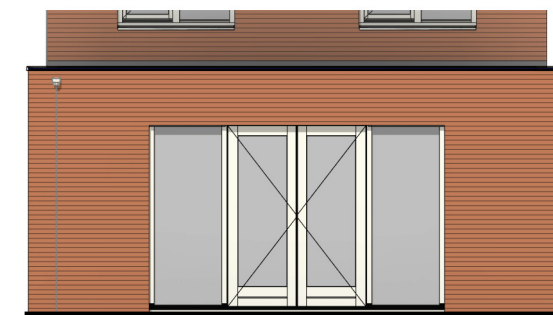
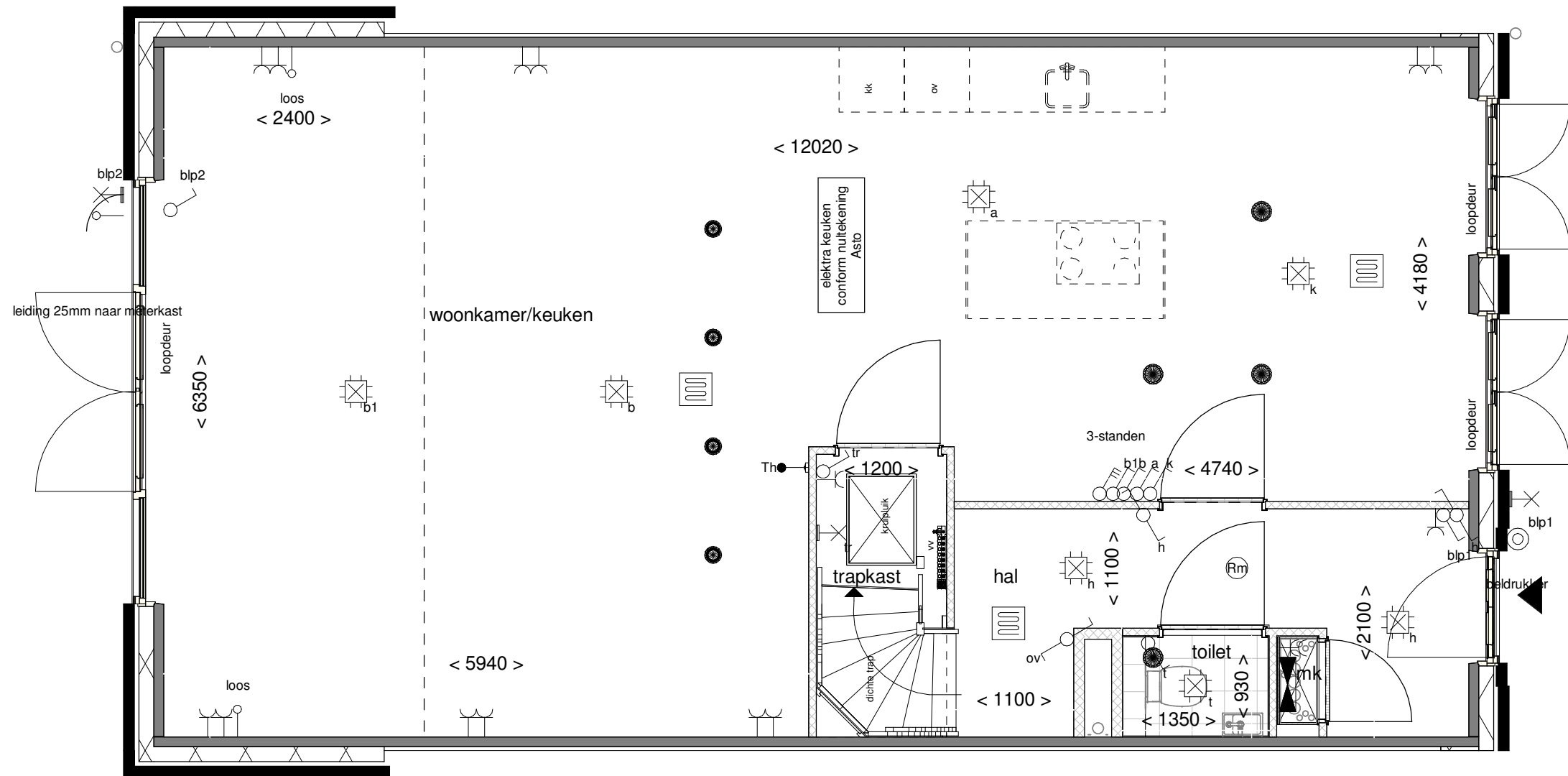

Achtergevel schaal 1:100

**ALLEMAAL  
VIELEJAAL**

Optie: Dubbele deuren  
achtergevel 3900mm

Woningtype: W66

Bouwnummer: -

Optienummer: 1.A.X.62

Schaal: 1:50 / 1:100

Datum: 27-10-2021

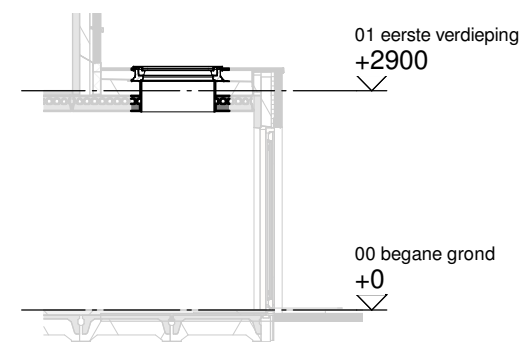
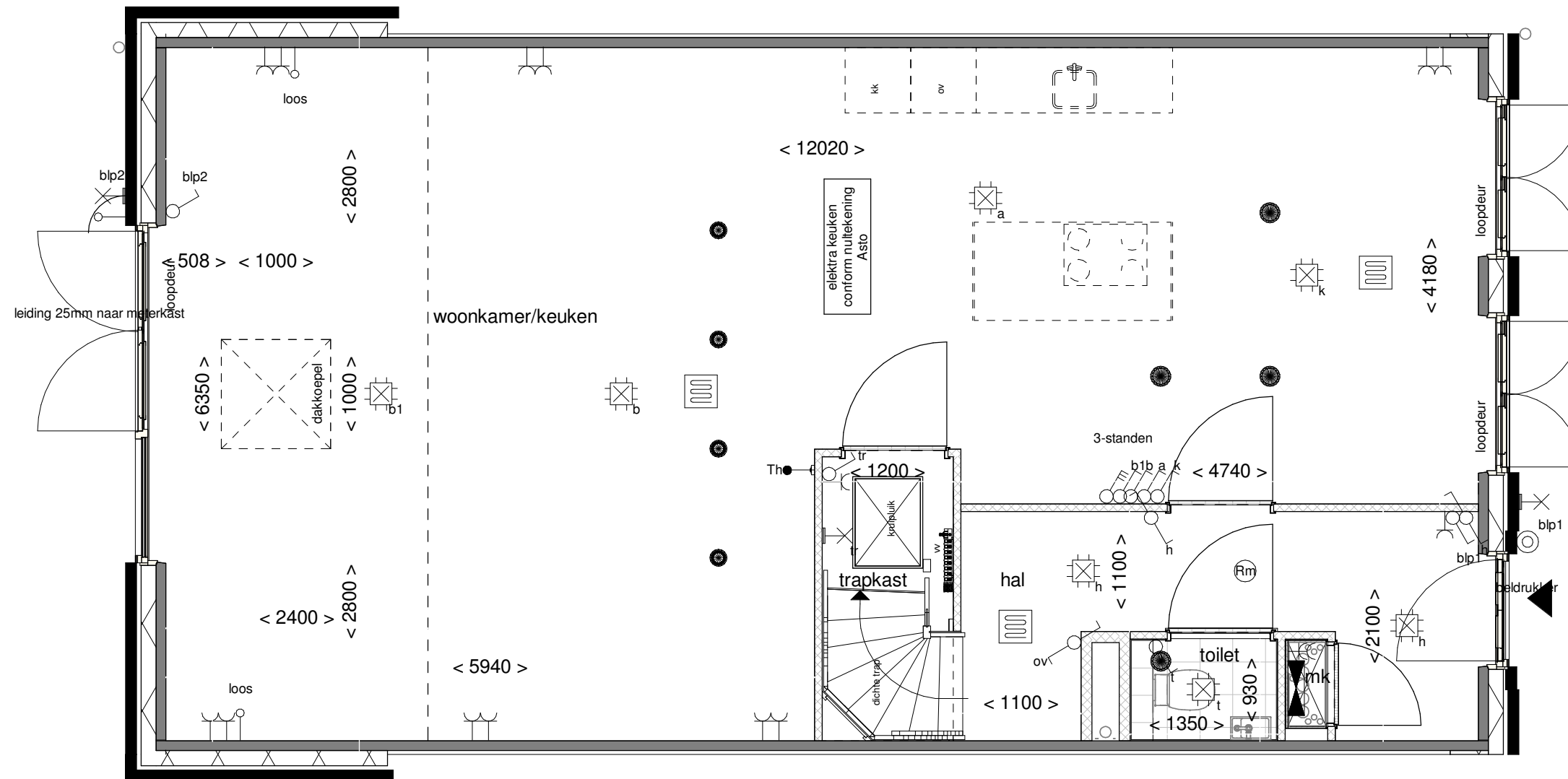

Doorsnede schaal 1:100

**ALLEMAAL  
YIELEYAAL**

Optie: Lichtkoepel in uitbouw 2400mm

Woningtype: W66

Bouwnummer: -

Optienummer: 1.B.X.10

Schaal: 1:50 / 1:100

Datum: 27-10-2021

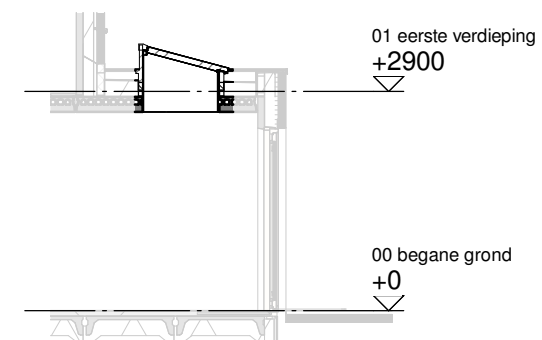
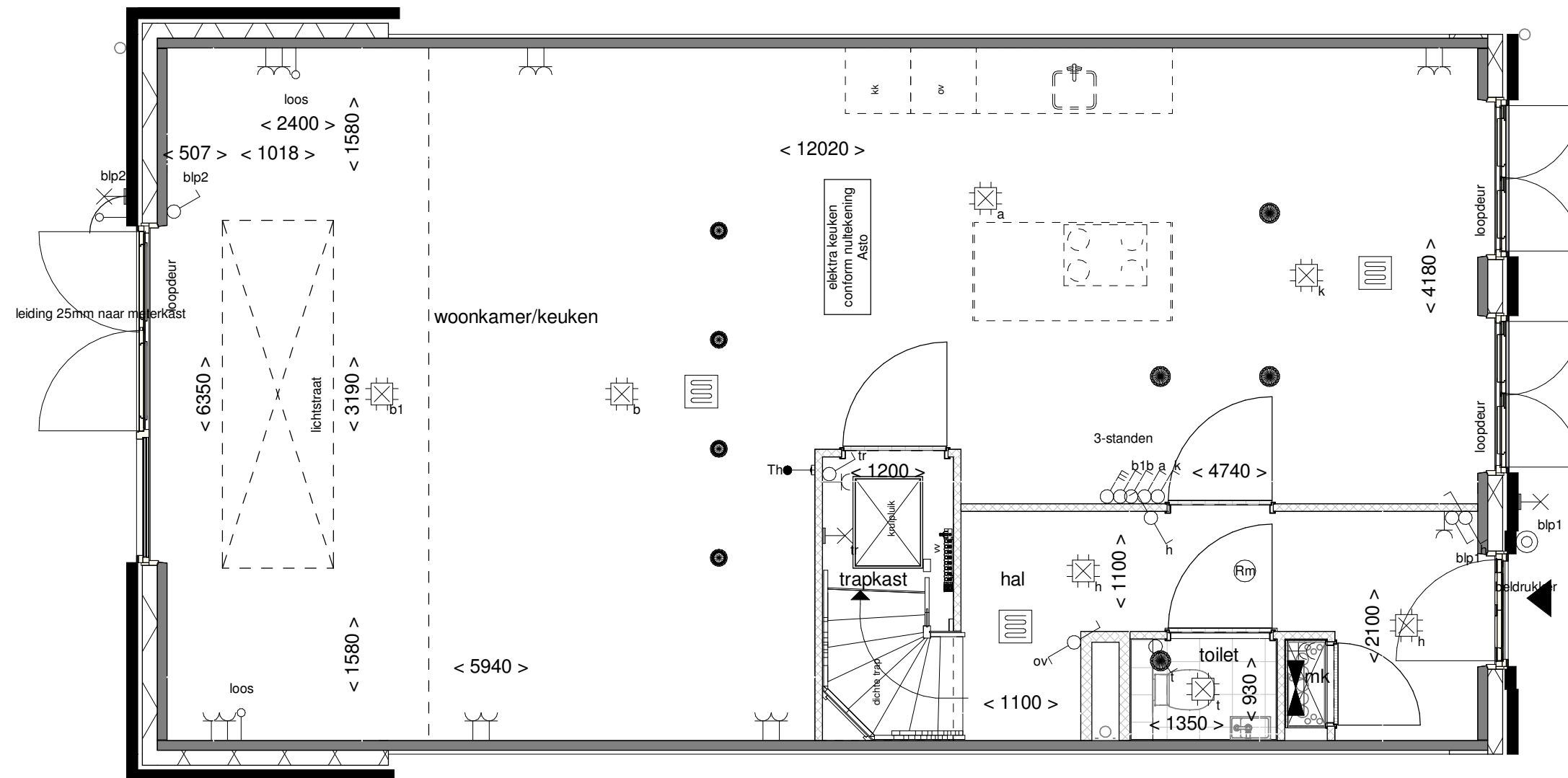

Doorsnede schaal 1:100

**ALLEMAAL  
VIELEJAAL**

Optie: Lichtstraat in uitbouw  
2400mm

Woningtype: W66

Bouwnummer: -

Optienummer: 1.B.X.14

Schaal: 1:50 / 1:100

Datum: 27-10-2021

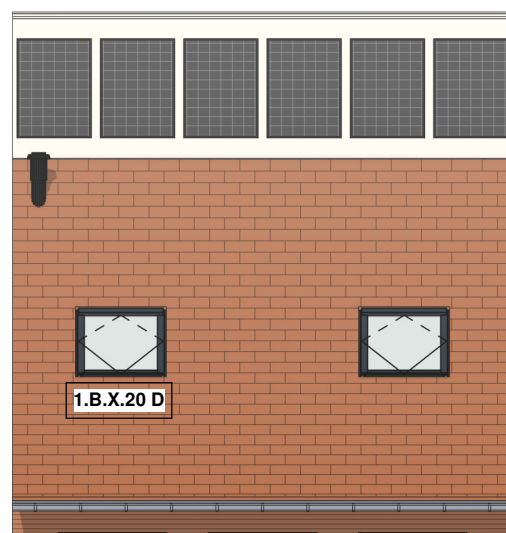
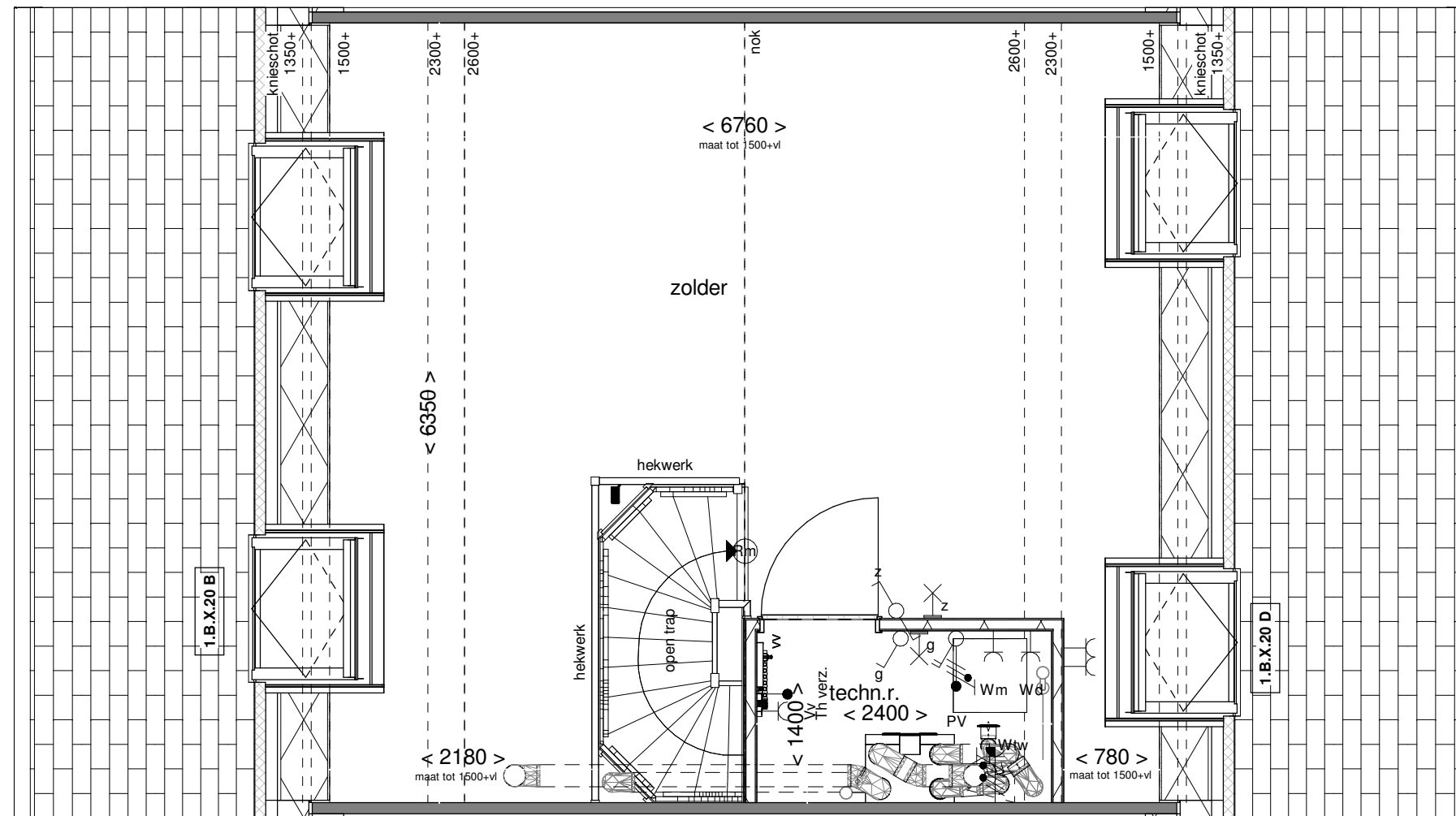

Voorgevel schaal 1:100

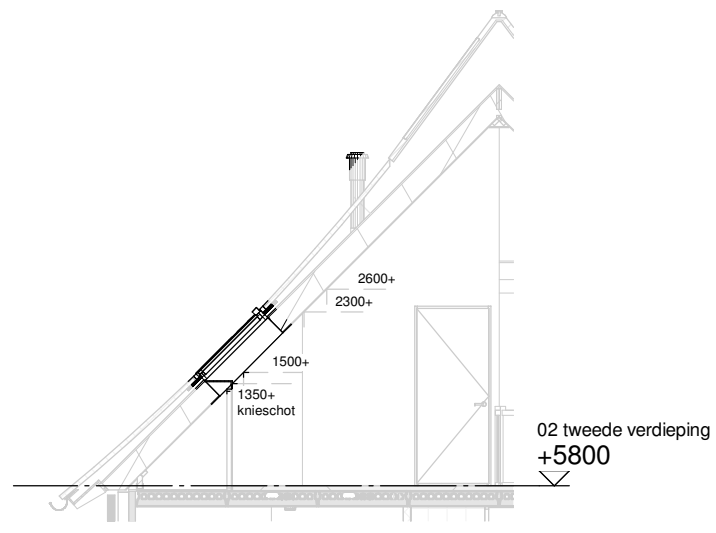

Doorsnede schaal 1:100

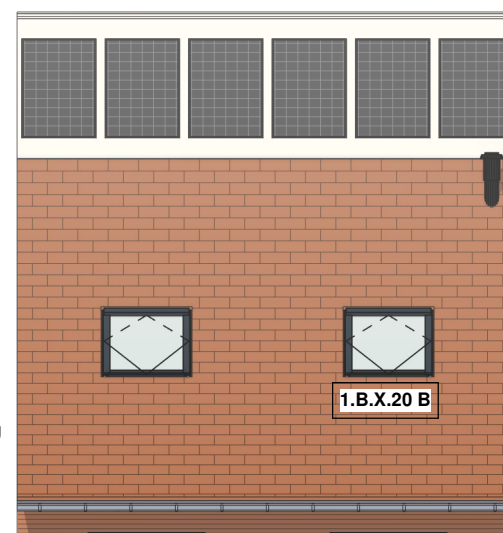

Achtergevel schaal 1:100

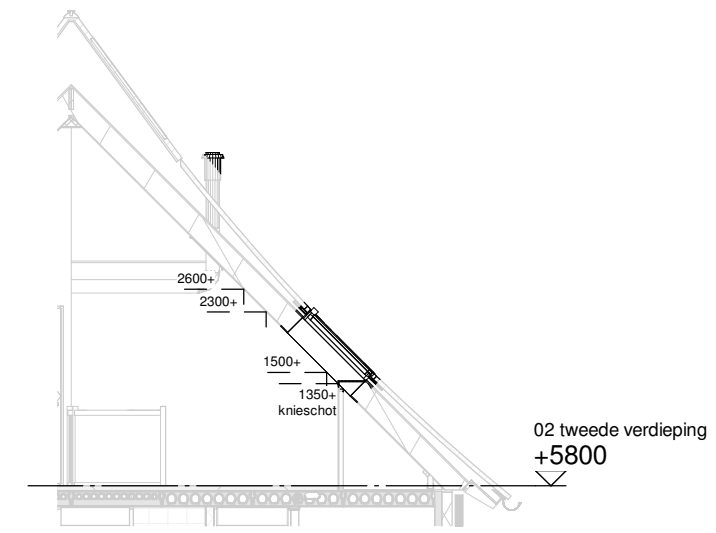

Doorsnede schaal 1:100

**ALLEMAAL  
YIELEYAAL**

Optie: Dakramen voor- en achtergevel

Woningtype: W66

Bouwnummer: -

Optienummer: 1.B.X.20

Schaal: 1:50 / 1:100

Datum: 27-10-2021



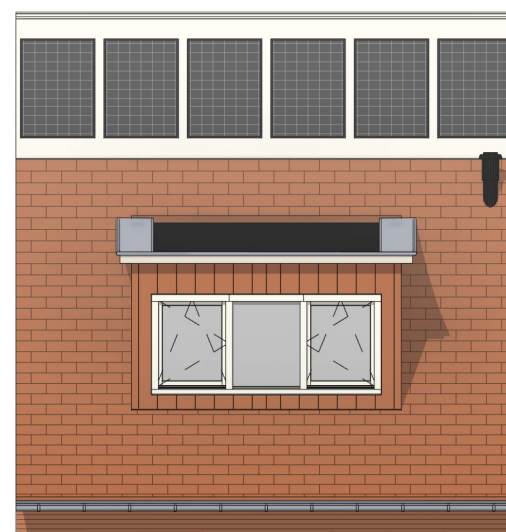
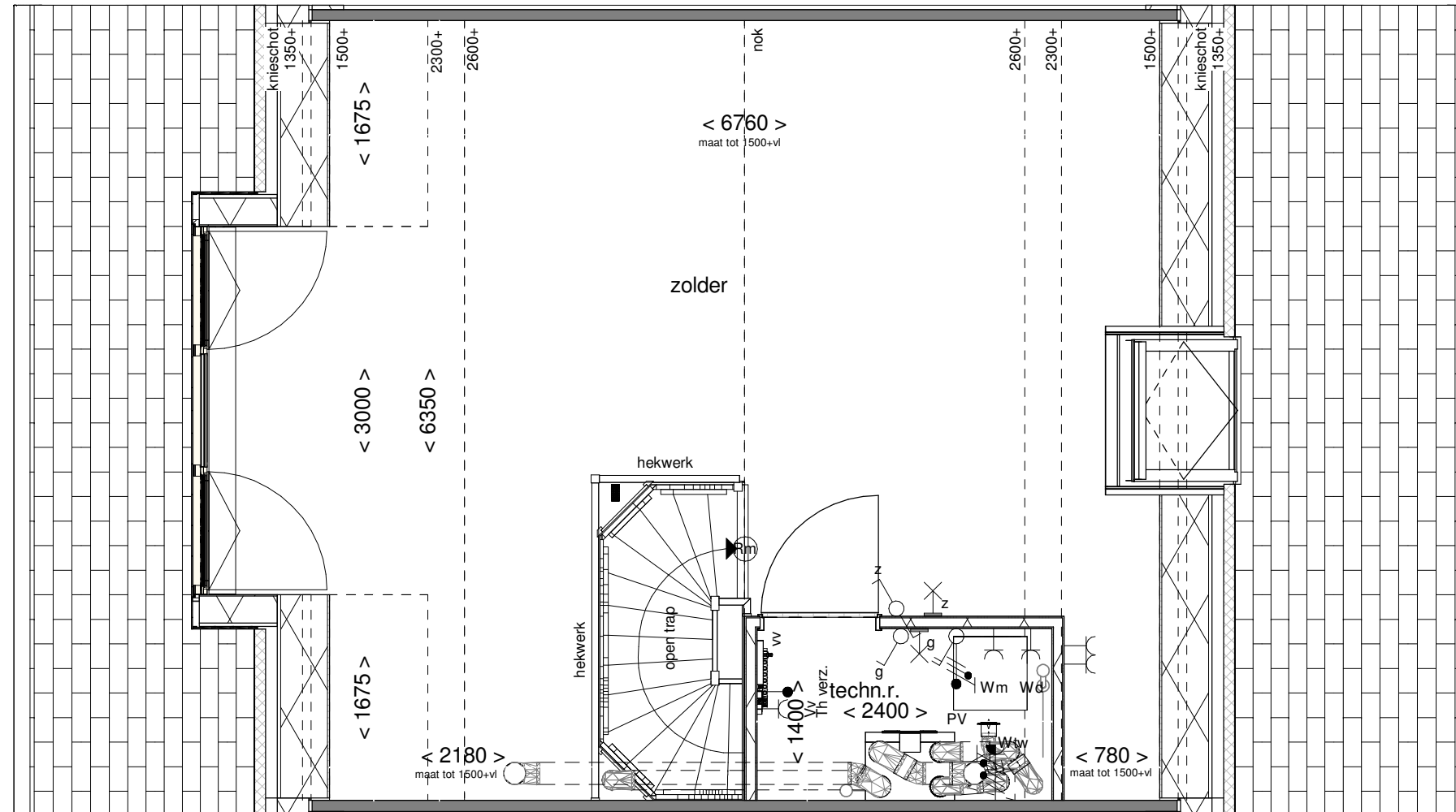

Achtergevel schaal 1:100

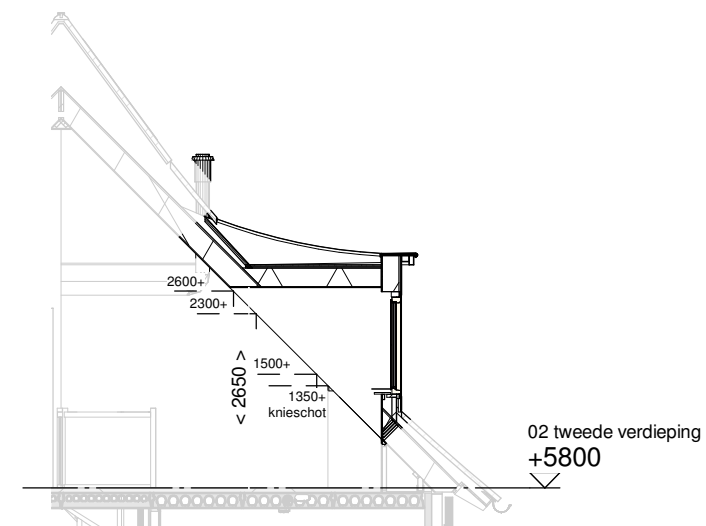

Doorsnede schaal 1:100

**ALLEMAAL  
YIELEYAAL**

Optie: Dakkapel  
achtergevel 3000mm

Woningtype: W66

Bouwnummer: -

Optienummer: 1.B.X.34

Schaal: 1:50 / 1:100

Datum: 27-10-2021

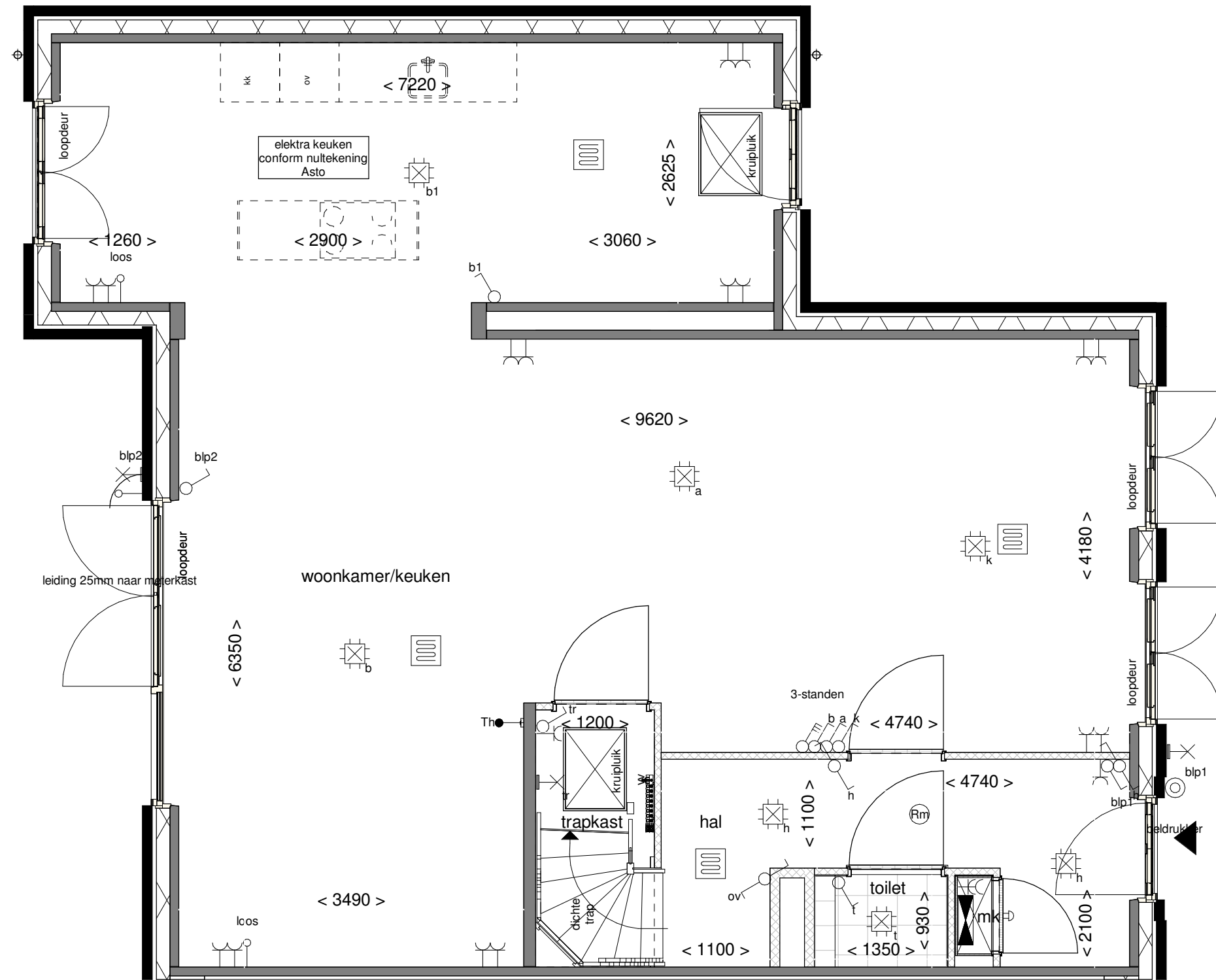

**ALLEMAAL  
VIELEJAAL**

Optie: Keuken in uitbouw  
1200mm

---

Woningtype: W66U

---

Bouwnummer: -

---

Optienummer: 1.C.W.12

---

Schaal: 1:50

---

Datum: 27-10-2021

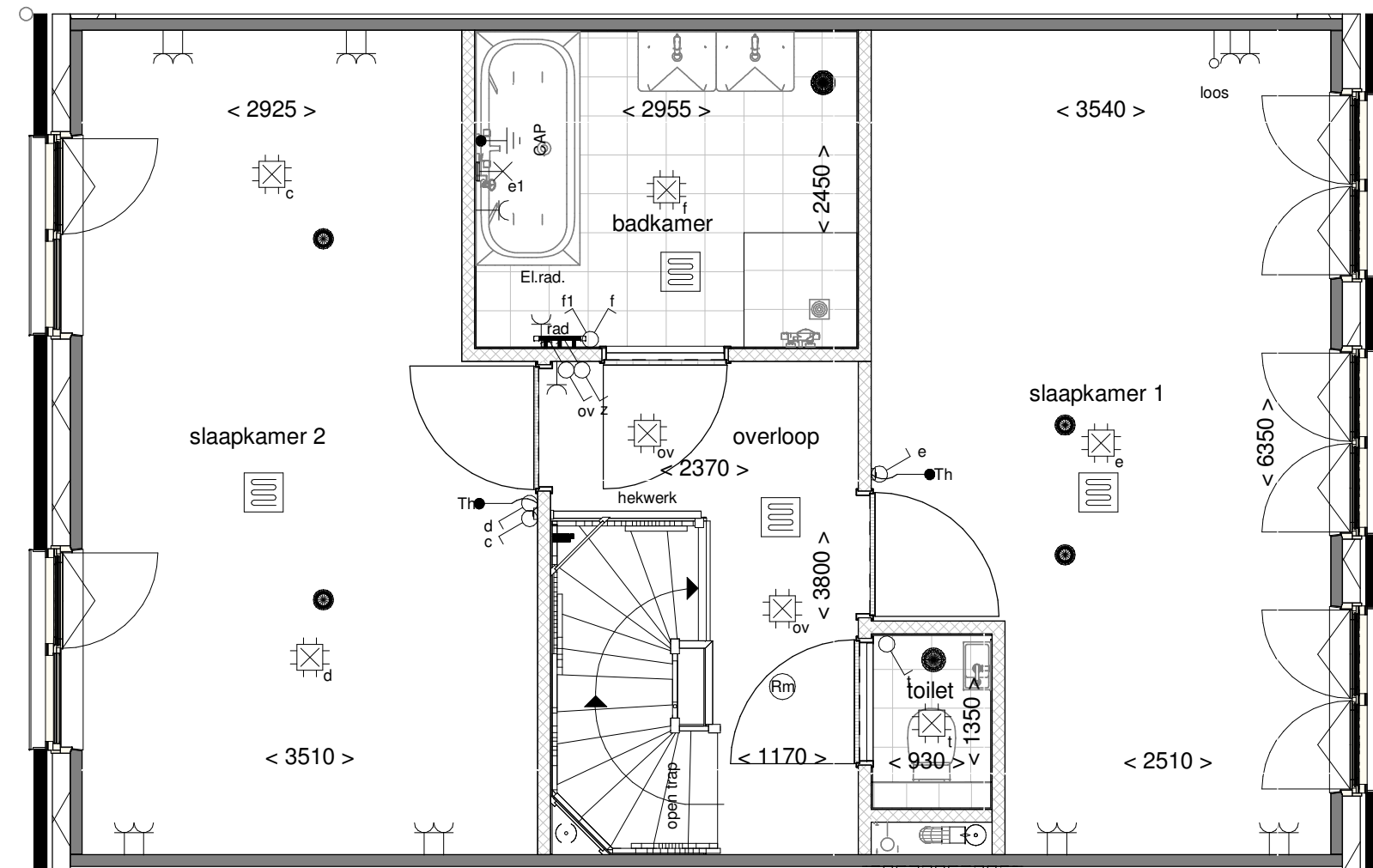

**ALLEMAAL  
YIELEYAAL**

Optie: Samenvoegen  
slaapkamer 2 en 3

Woningtype: W66

Bouwnummer: -

Optienummer: 1.C.W.32

Schaal: 1:50

Datum: 27-10-2021

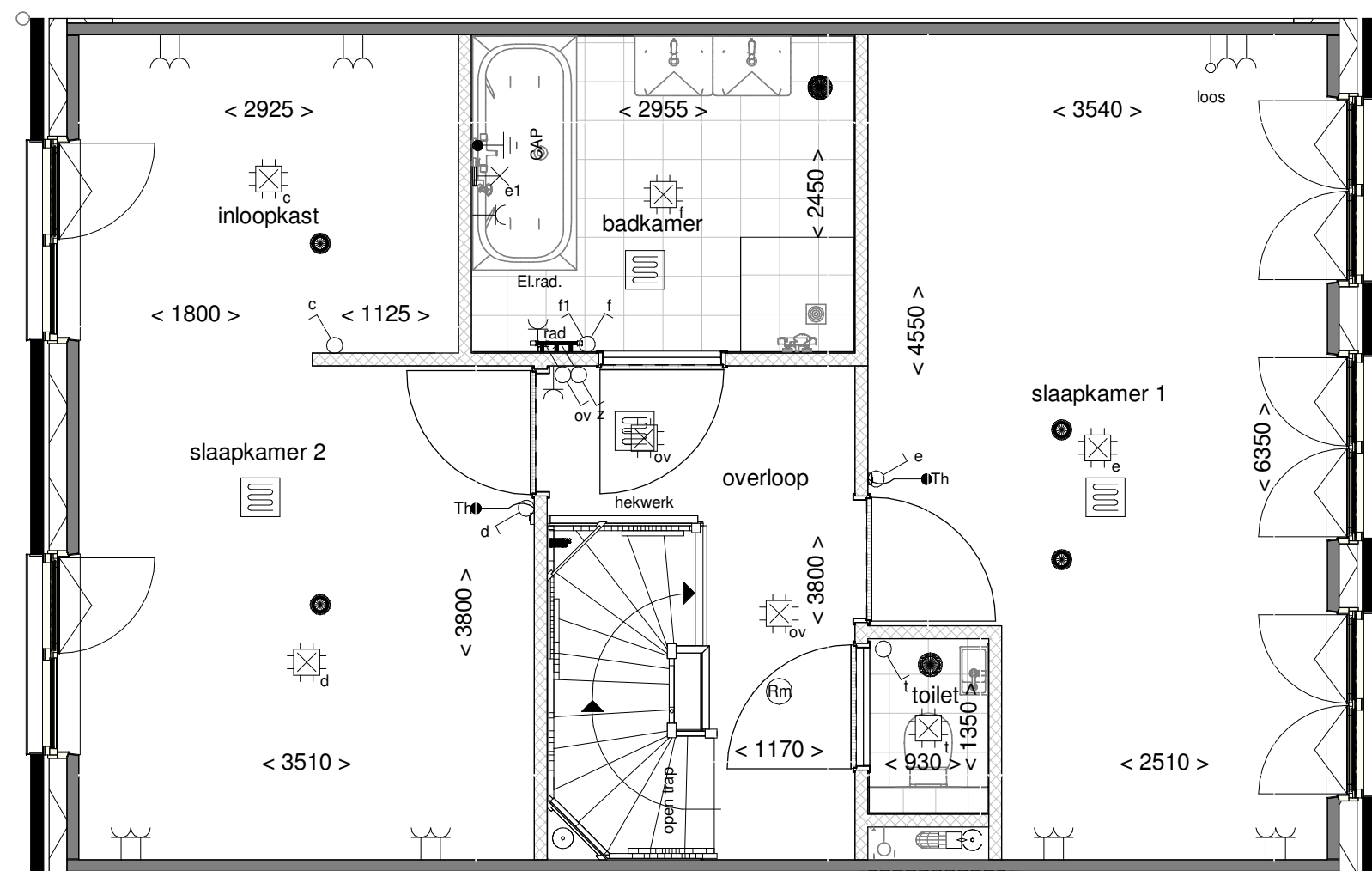

**ALLEMAAL  
YIELEYAAL**

Optie: Samenv. slaapk. 2  
en 3 met inloopkast

Woningtype: W66

Bouwnummer: -

Optienummer: 1.C.W.42

Schaal: 1:50

Datum: 27-10-2021

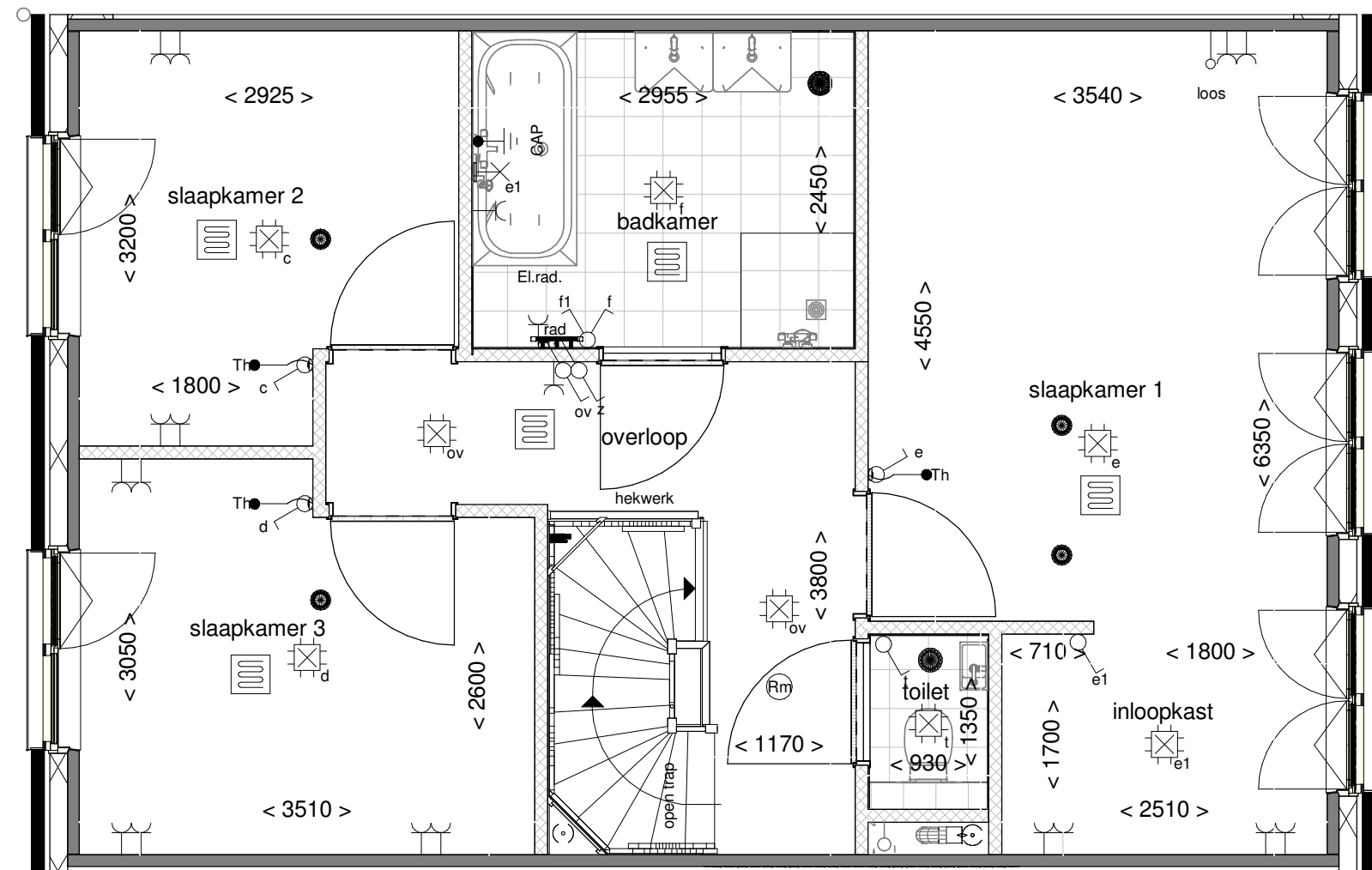

**ALLEMAAL  
YIELEYAAL**

Optie: Inloopkast in  
slaapkamer 1

Woningtype: W66

Bouwnummer: -

Optienummer: 1.C.W.44

Schaal: 1:50

Datum: 27-10-2021

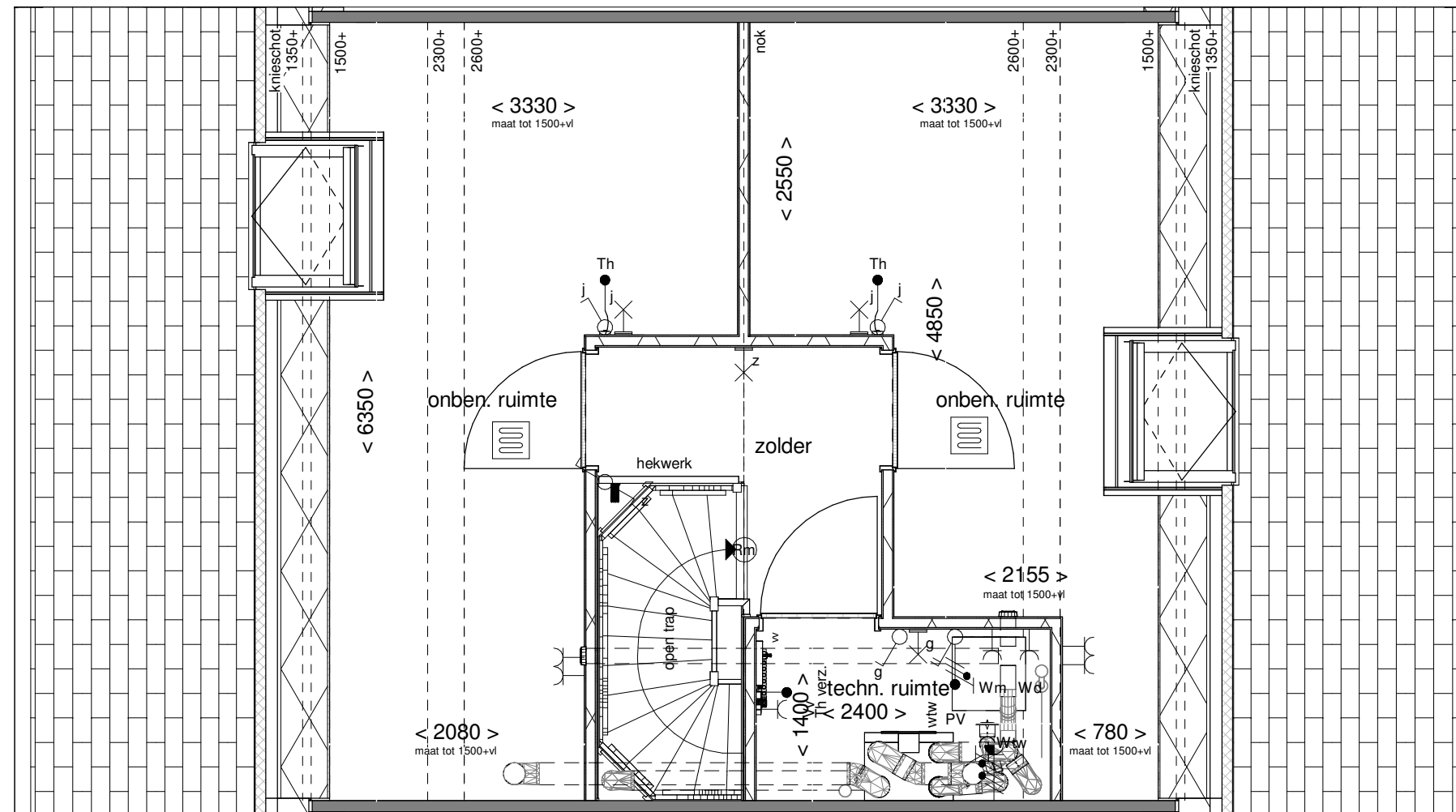

**ALLEMAAL  
YIELEYAAL**

Optie: Indeling techn.- en 2  
onb. ruimtes

Woningtype: W66

Bouwnummer: -

Optienummer: 1.C.W.76

Schaal: 1:50

Datum: 27-10-2021