

**ALLEMAAL
YIELEYAAL**

Tekening: **Situatie totaal**

Woningtype:

Bouwnummer:

Bladnummer: **VT-S-01**

Schaal: **1:1000**

Datum: **29-09-2021**

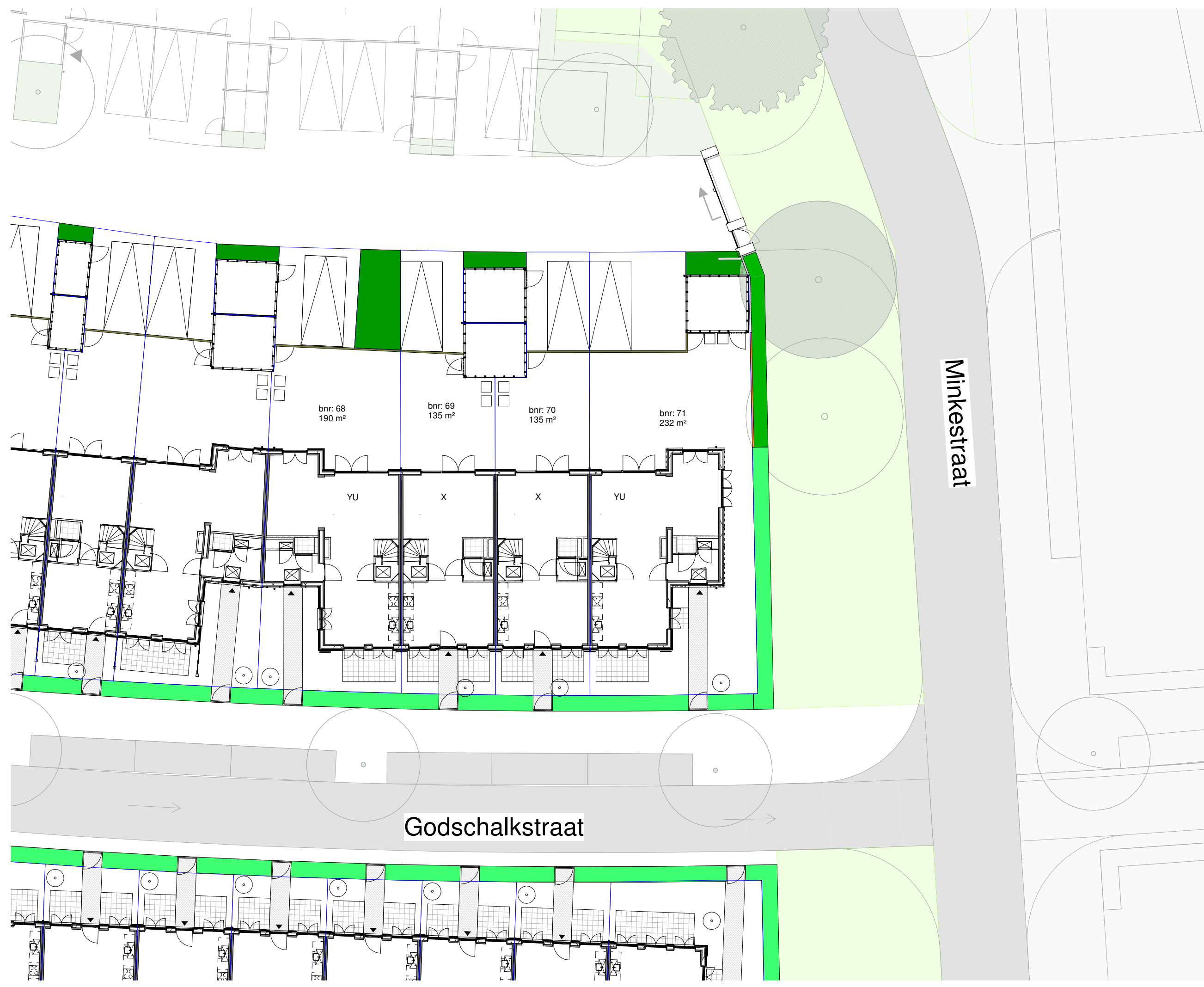

Renvooi

-  - entree woning
-  - parkeervak eigen terrein
-  - erfgrans
-  - beplanting type n.t.b. koper
-  - opstelplaats klike
-  - tuinhekje
-  - klinkerbestrating
-  - betontegels 300x300mm
-  - groen strook
-  - haag h=900mm
-  - haag h=1800mm
-  - bamboehak h=1800mm
-  - gaashek met klimplanten en poort h=1600mm













parkeerplekken en posities bomen en struiken zijn indicatief

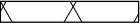



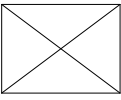





















**ALLEMAAL
YIELEYAAL**

Tekening:	Situatie Blok C6
Woningtype:	YU,X
Bouwnummer:	68-71
Bladnummer:	VT-S-04
Schaal:	1:200
Datum:	29-09-2021

Renvooi bouwkundig

	metselwerk kleur A
	dakpannen kleur oranje
	entree woning
	metselwerk
	isolatie
	dragende wand
	niet dragende binnenwand
	binnendeurkozijn (met bovenlicht)
	kruipluik
	opstelplaats wasmachine
	opstelplaats wasdroger
	
	principe opstelling keukenblok

Renvooi installaties

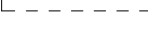
	aansluitpunt licht
	aansluitpunt licht, wand
	centraaldoos met lichtpunt
	armatuur aan de wand
	rookmelder
	aansluitpunt niet bedraad
	verdeelinrichting / meterkast / groepenkast
	beldrukker
	schel
	schakelaar, 1-polig
	werkschakelaar tbv PV-panelen
	schakelaar, 3-polig
	schakelaar, wissel
	schakelaar, kruis
	schakelaar, serie
	wandcontactdoos 1-voudig met beschermingscontact
	wandcontactdoos 2-voudig met beschermingscontact, verticaal
	wandcontactdoos 2-voudig met beschermingscontact
	thermostaatleiding, bedraad
	mechanische ventilatie-unit incl. warmteterugwinunit
	warmtepomp
	inblaasventiel mechanische ventilatie
	uitblaasventiel mechanische ventilatie
	verdeler vloerverwarming
	ruimte voorzien van vloerverwarming
	elektrische radiator
	kanalen in het zicht
	onbenoemde ruimte volgens krijstreepmethode

Disclaimer

De op deze tekeningen aangegeven maten zijn circa maten in millimeters en tussen de wanden / vloeren gemeten, waarbij geen rekening is gehouden met enige wandafwerking, plinten, aftimmering, ect. In verband met de nauwkeurige uitwerking van details, constructie, maatvoering, materialen e.d. kunnen er kleine afwijkingen ontstaan ten opzichte van de nu vermelde gegevens. Deze geringe afwijkingen geven geen aanleiding tot verrekening. Aan de op deze tekening aangegeven maten kunnen derhalve geen rechten worden ontleend. De op deze tekeningen aangegeven maatvoering is niet geschikt voor opdrachten aan derden door koper(s). De posities van aansluitingen en installatie onderdelen zijn indicatief op tekening aangegeven. De exacte aantallen en posities zullen na berekening in het werk door de installateurs worden bepaald en kunnen afwijken van deze tekening.

**ALLEMAAL
YIELEYAAL**

Tekening: Renvooi

Woningtype: -

Bouwnummer: -

Bladnummer: VT-0-00c

Schaal: -

Datum: 29-09-2021

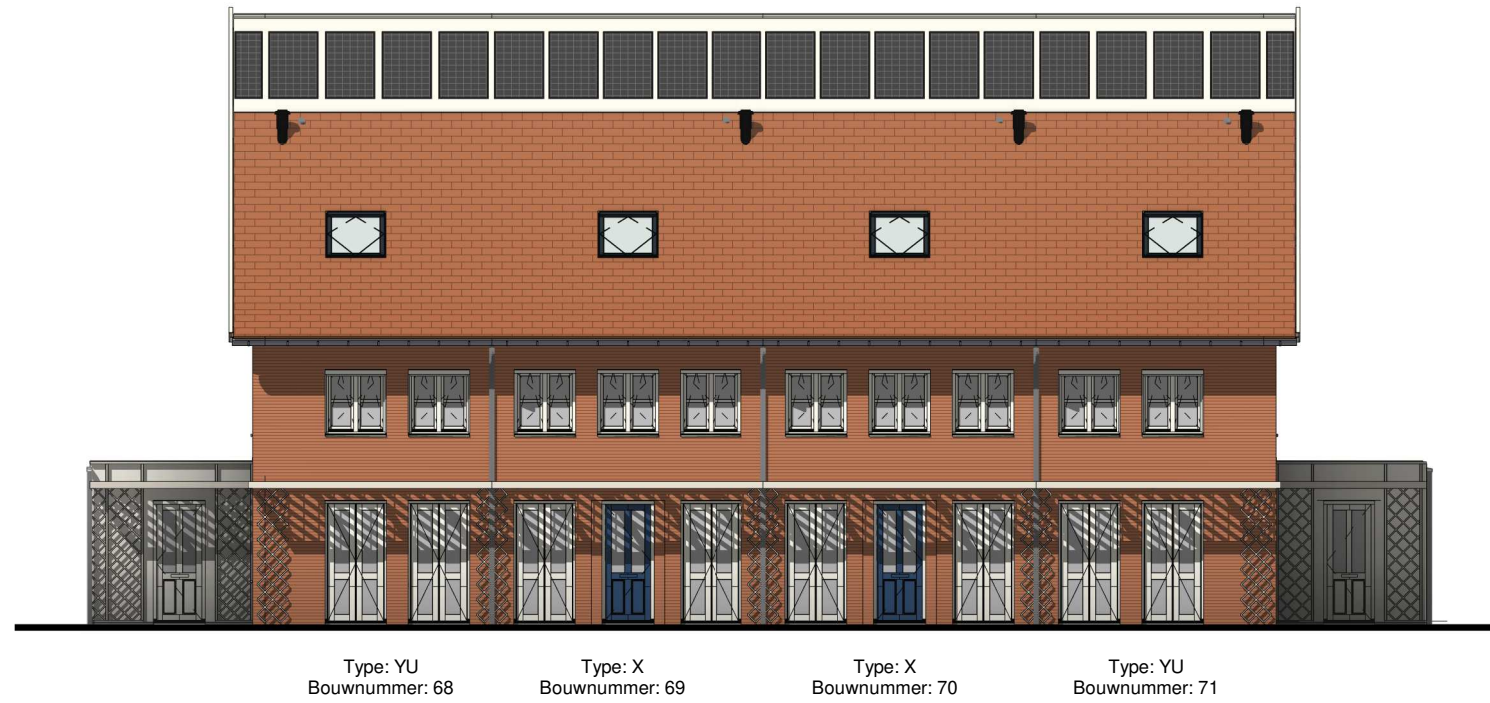

Voorgevel

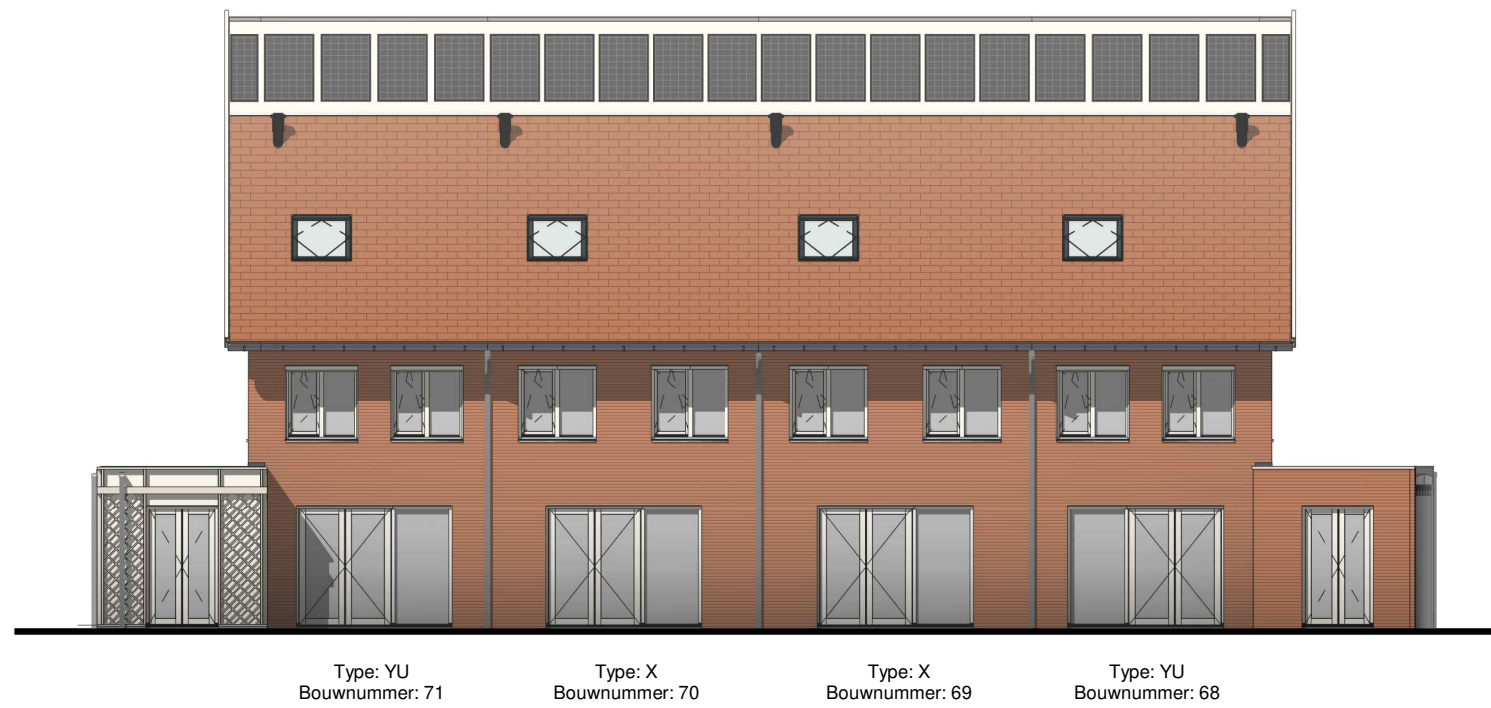

Achtergevel

ALLEMAAL
YIELEYAAL

Tekening: Gevels blok C6

Woningtype: YU, X

Bouwnummer: 68 t/m 71

Bladnummer: VT-C6-00a

Schaal: 1:150

Datum: 29-09-2021



Type: YU
Bouwnummer: 68

Linker zijgevel



Type: YU
Bouwnummer: 71

Rechter zijgevel

**ALLEMAAL
YIELEYAAL**

Tekening: Zijgevels blok C6

Woningtype: YU, X

Bouwnummer: 68 t/m 71

Bladnummer: VT-C6-00b

Schaal: 1:100

Datum: 29-09-2021

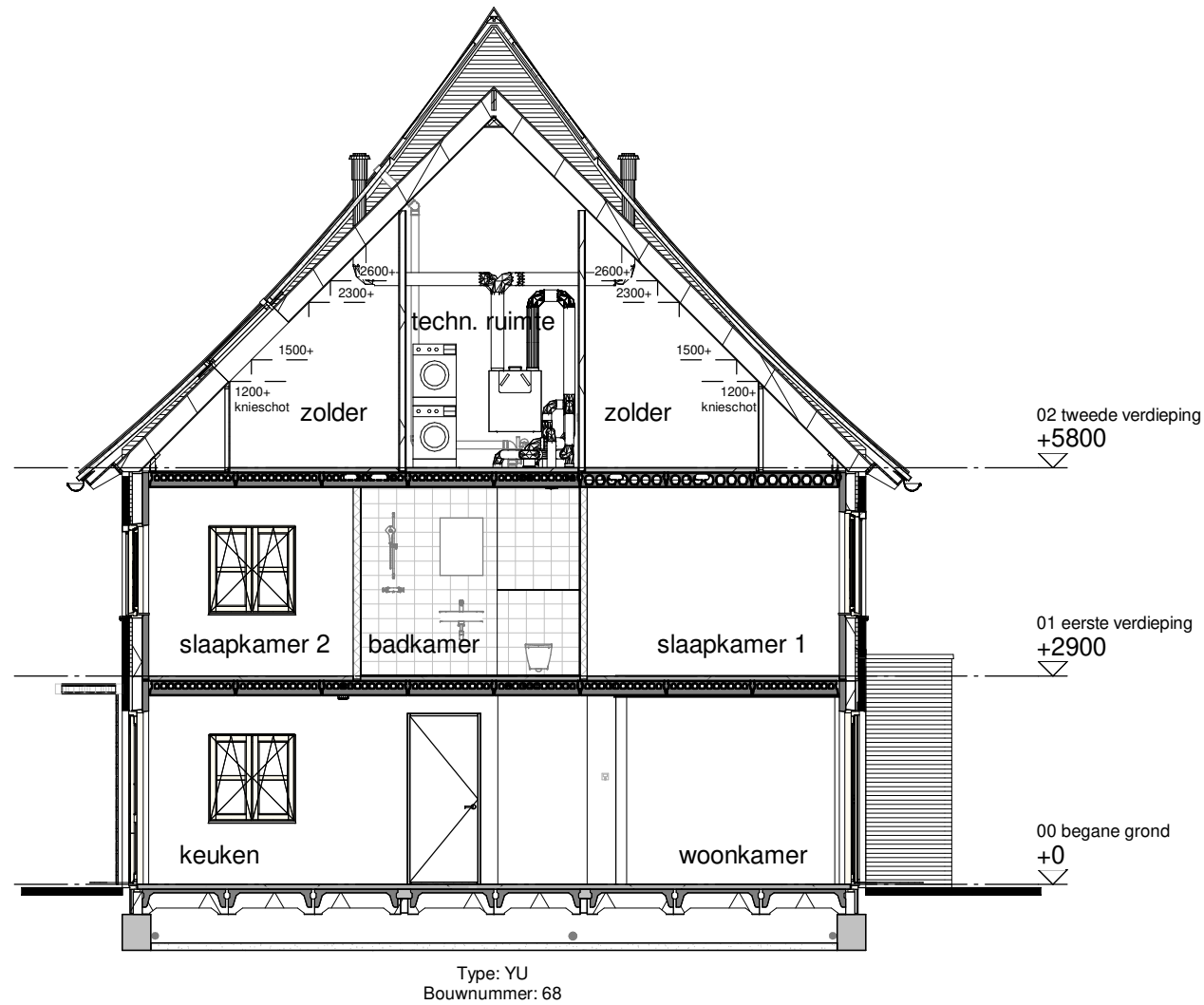

Doorsnede A

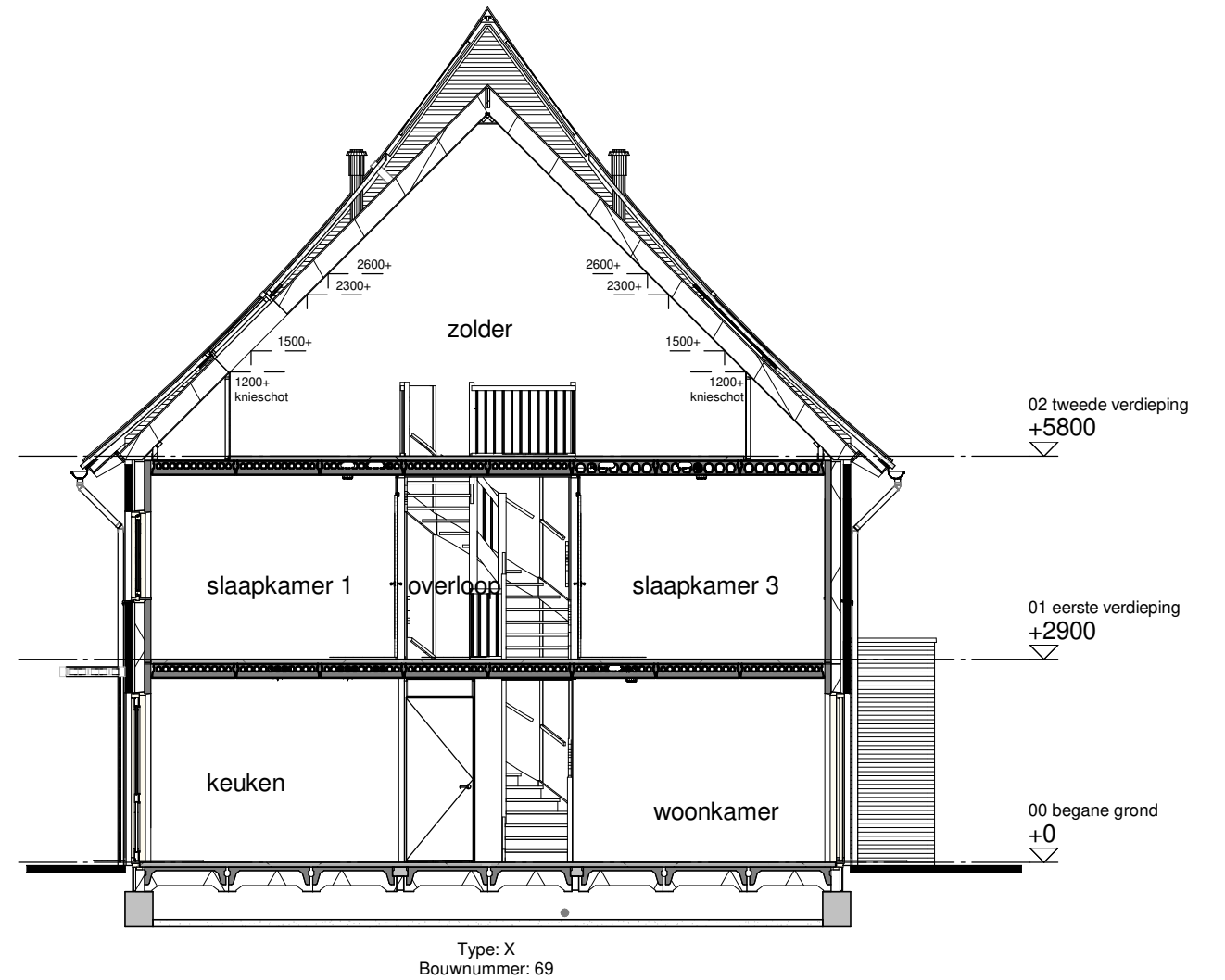

Doorsnede B

**ALLEMAAL
YIELEYAAL**

Tekening: Doorsneden blok C6

Woningtype: YU, X

Bouwnummer: 68 t/m 71

Bladnummer: VT-C6-00c

Schaal: 1:100

Datum: 29-09-2021

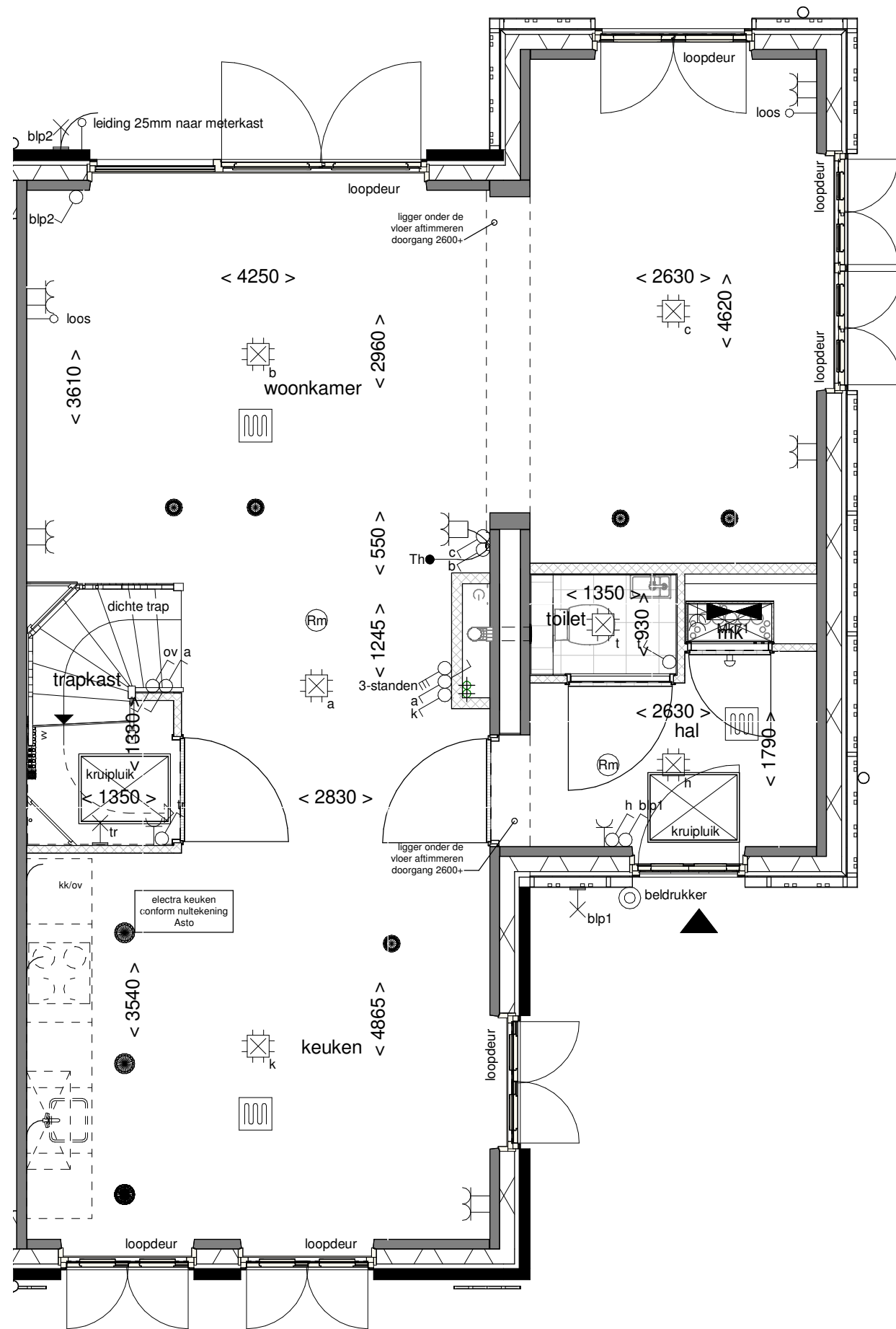

**ALLEMAAL
YIELEYAAL**

Tekening: Begane grond

Woningtype: YU

Bouwnummer: 71

Bladnummer: VT-C6-71a

Schaal: 1:50

Datum: 29-09-2021

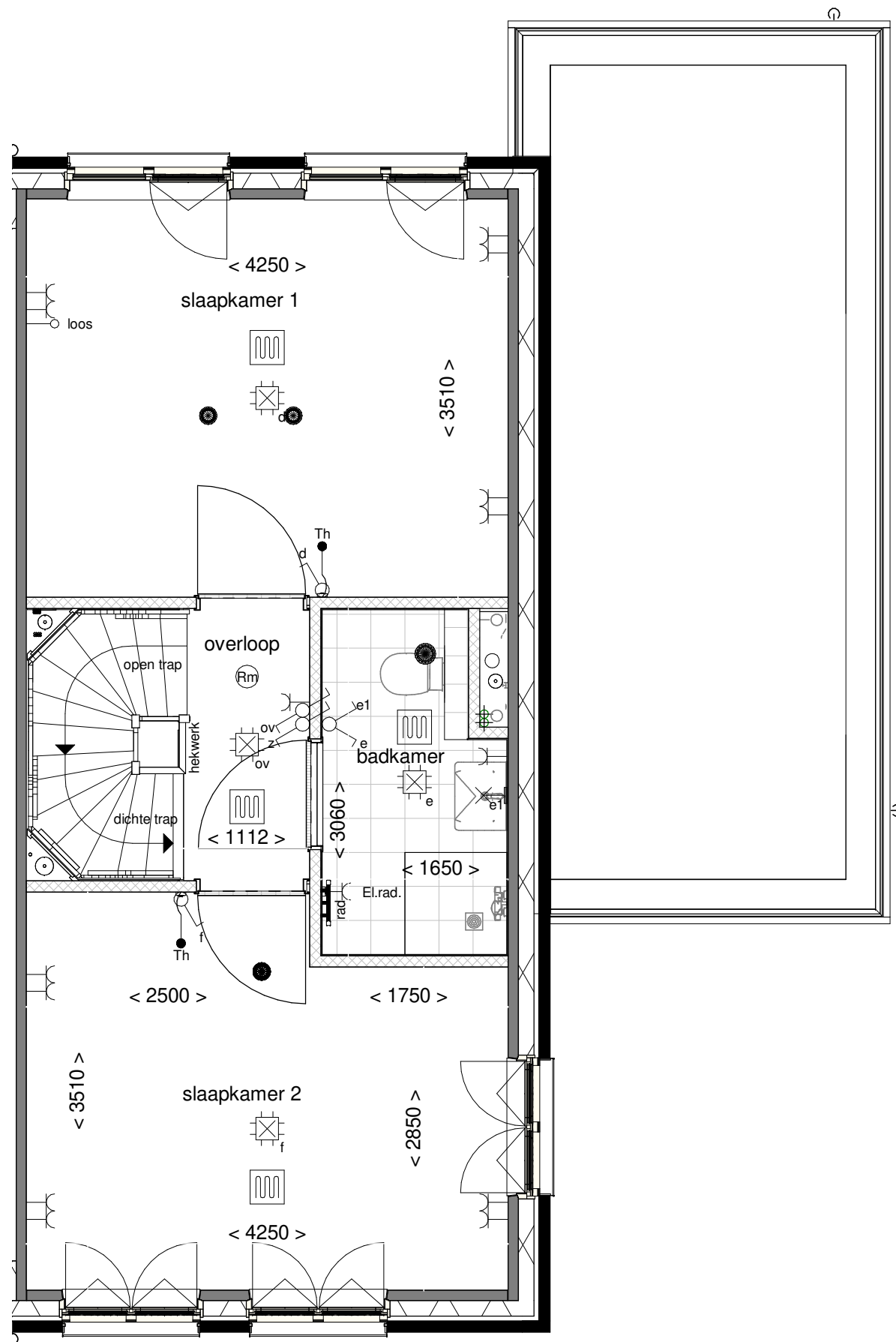

**ALLEMAAL
YIELEYAAL**

Tekening: Eerste verdieping

Woningtype: YU

Bouwnummer: 71

Bladnummer: VT-C6-71b

Schaal: 1:50

Datum: 29-09-2021

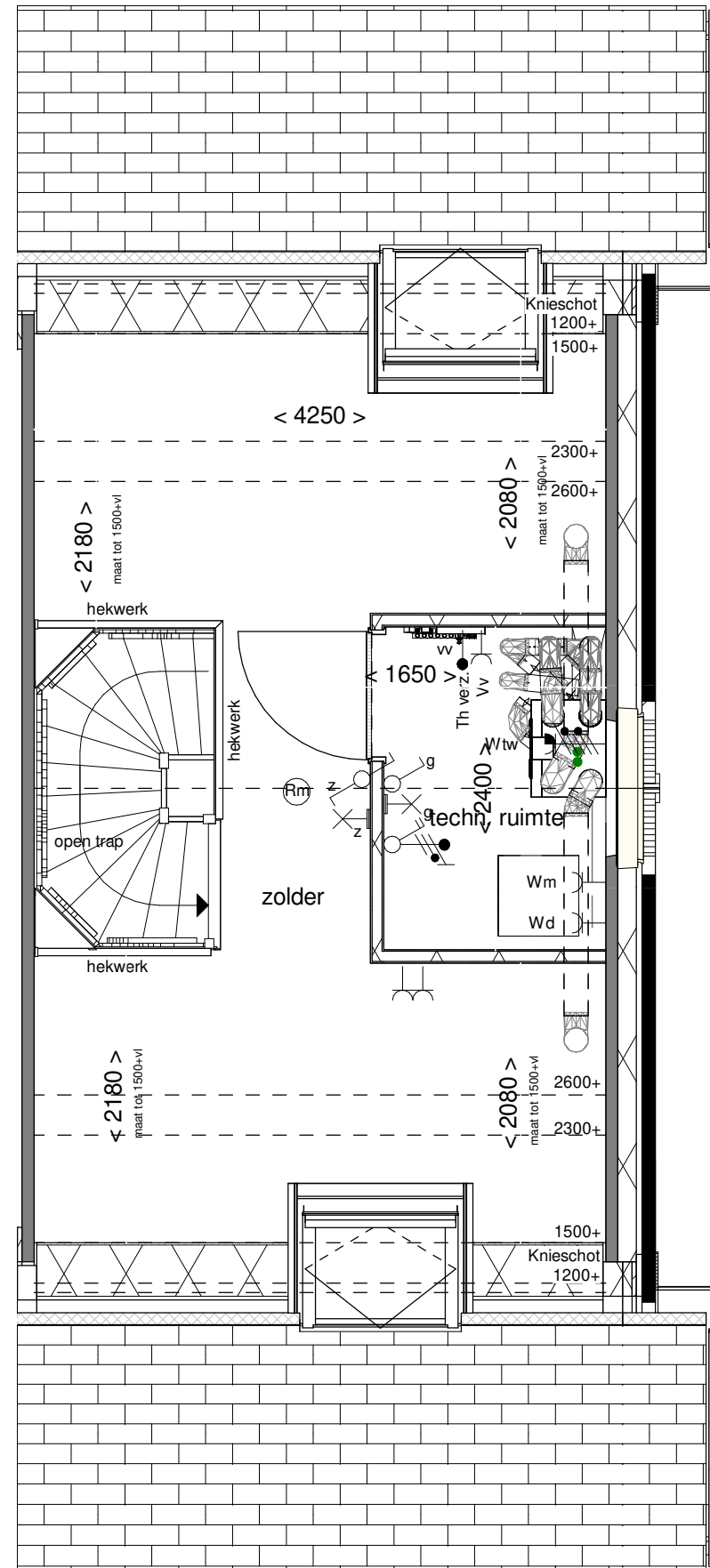

**ALLEMAAL
YIELEYAAL**

Tekening: Tweede verdieping

Woningtype: YU

Bouwnummer: 71

Bladnummer: VT-C6-71c

Schaal: 1:50

Datum: 29-09-2021

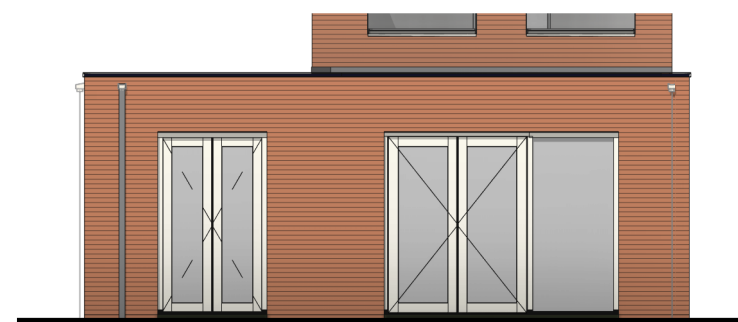
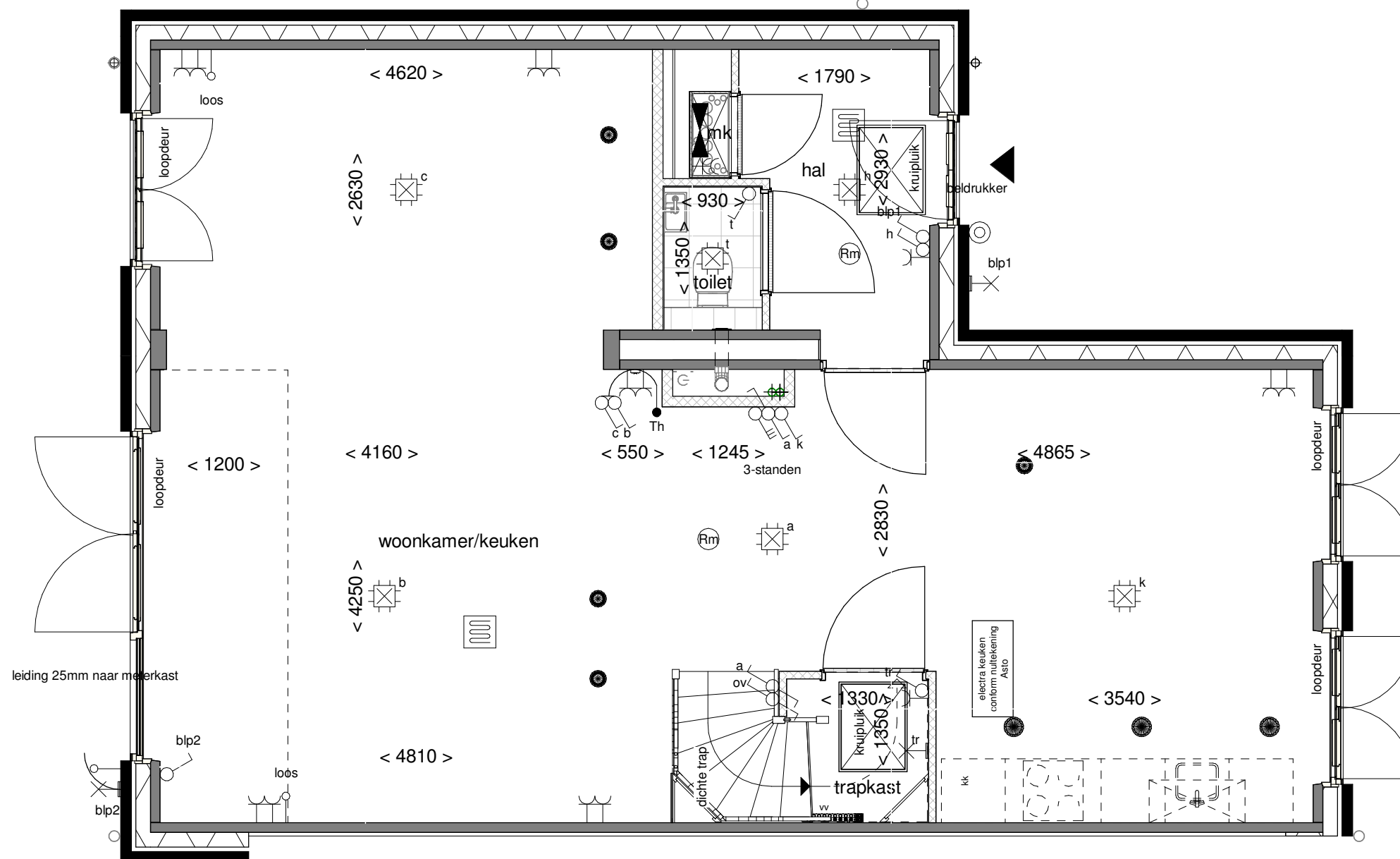

Achtergevel schaal 1:100

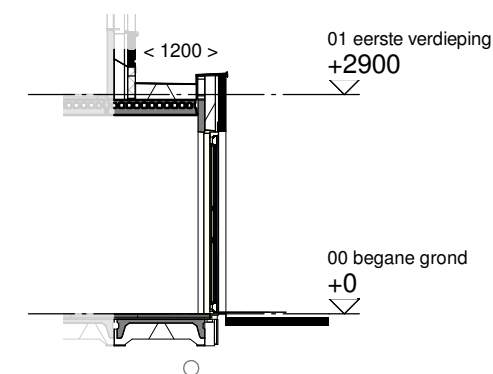

Doorsnede schaal 1:100

**ALLEMAAL
YIELEYAAL**

Optie: **Uitbouw achtergevel
1200mm**

Woningtype: **Y45U**

Bouwnummer: -

Optienummer: **0.A.Y.14**

Schaal: **1:50 / 1:100**

Datum: **29-09-2021**

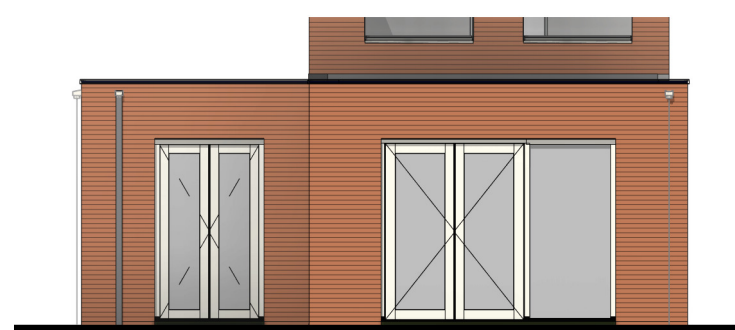
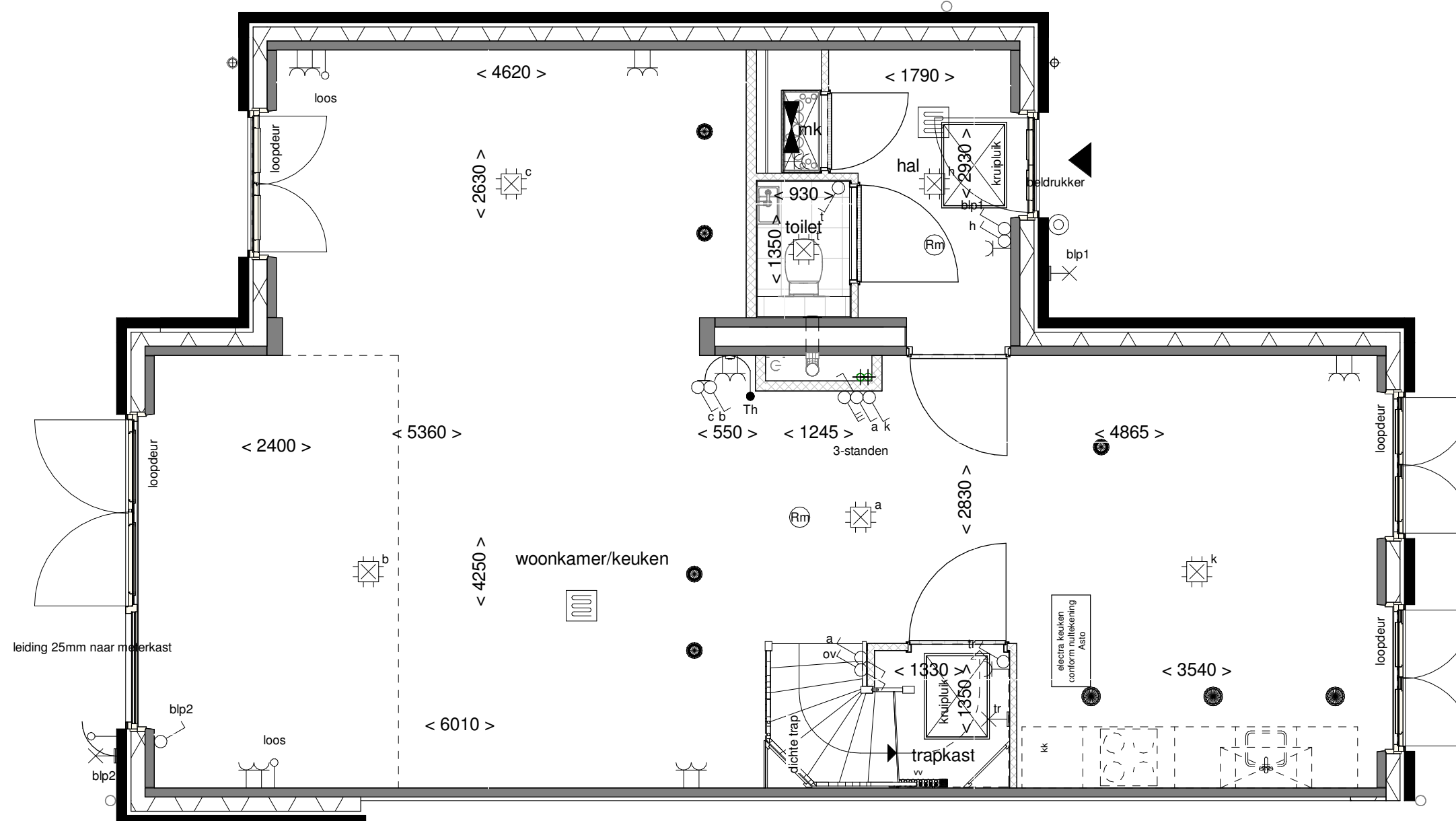

Achtergevel schaal 1:100

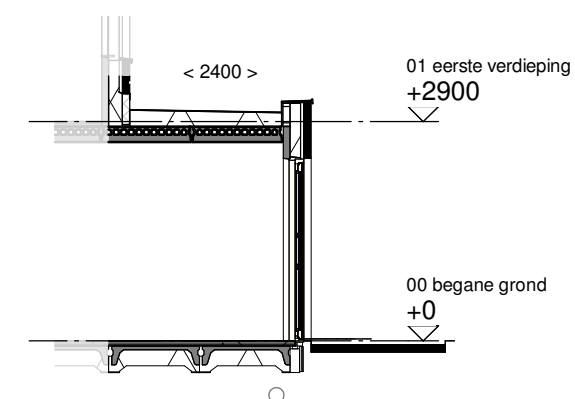

Doorsnede schaal 1:100

**ALLEMAAL
YIELEYAAL**

Optie: **Uitbouw achtergevel
2400mm**

Woningtype: **Y45U**

Bouwnummer: -

Optienummer: **0.A.Y.34**

Schaal: **1:50 / 1:100**

Datum: **29-09-2021**

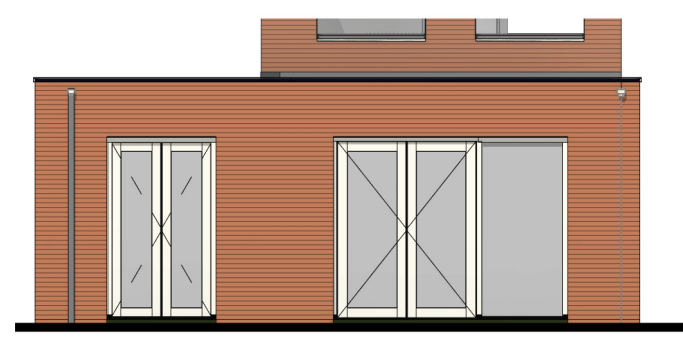
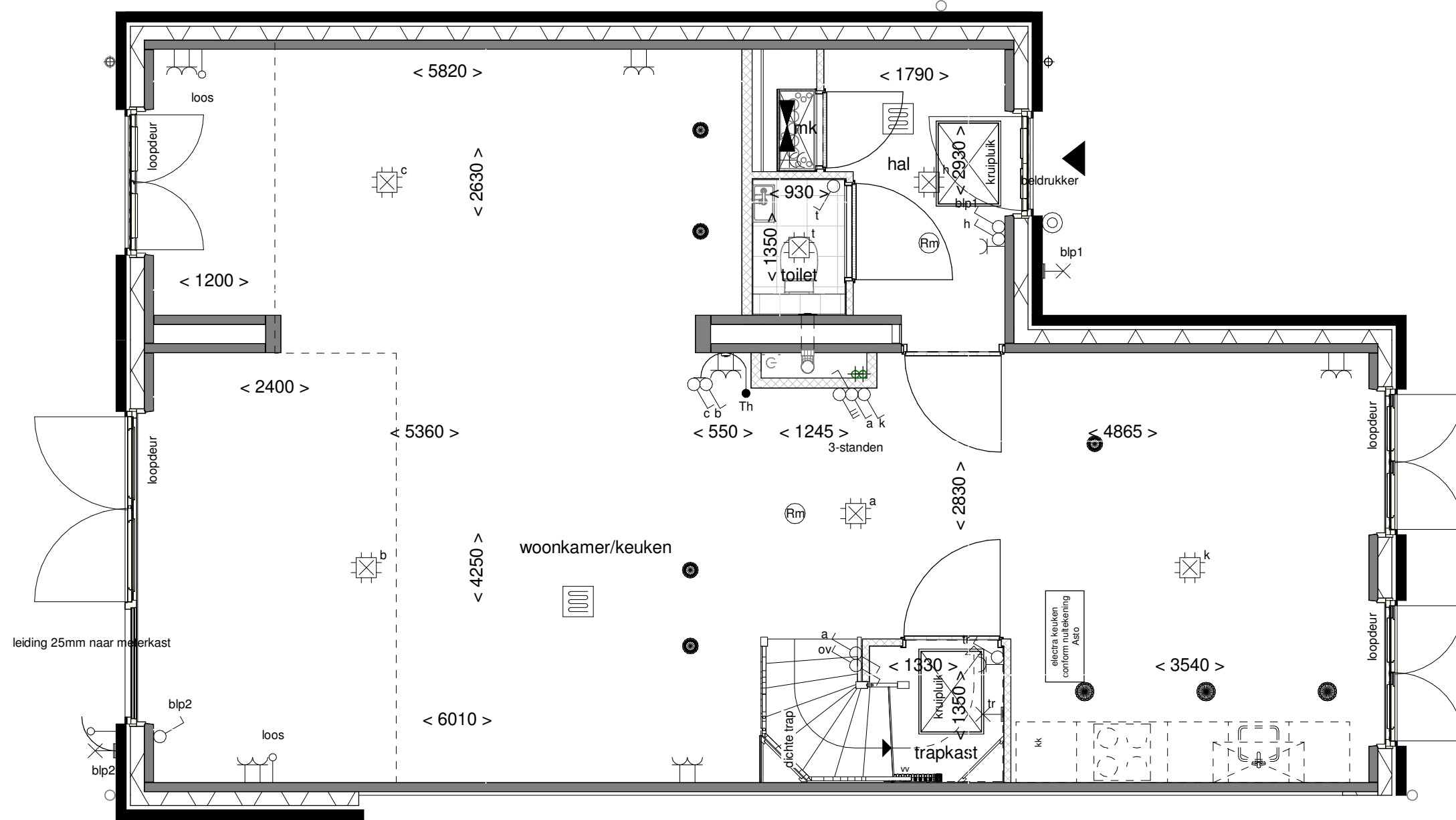

Achtergevel schaal 1:100

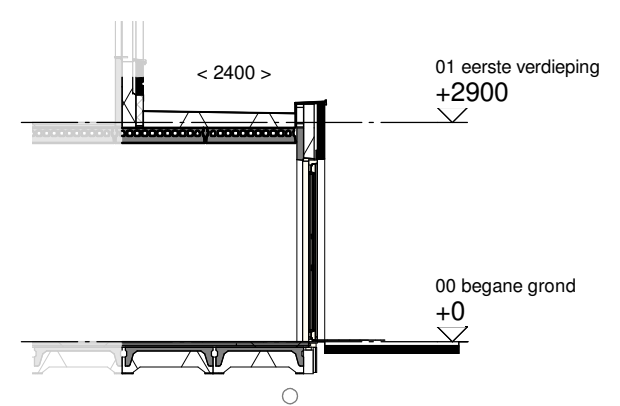

Doorsnede schaal 1:100

**ALLEMAAL
YIELEYAAL**

Optie: Uitb. achter 2400mm
+ zijuitbouw 1200mm

Woningtype: Y45U

Bouwnummer: -

Optienummer: 0.A.Y.52B

Schaal: 1:50 / 1:100

Datum: 29-09-2021

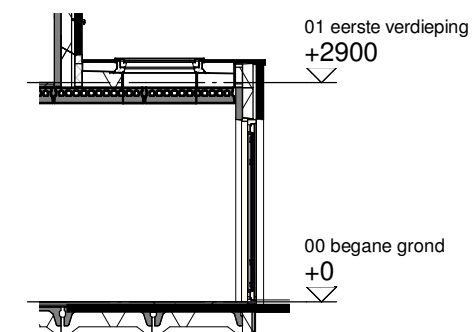
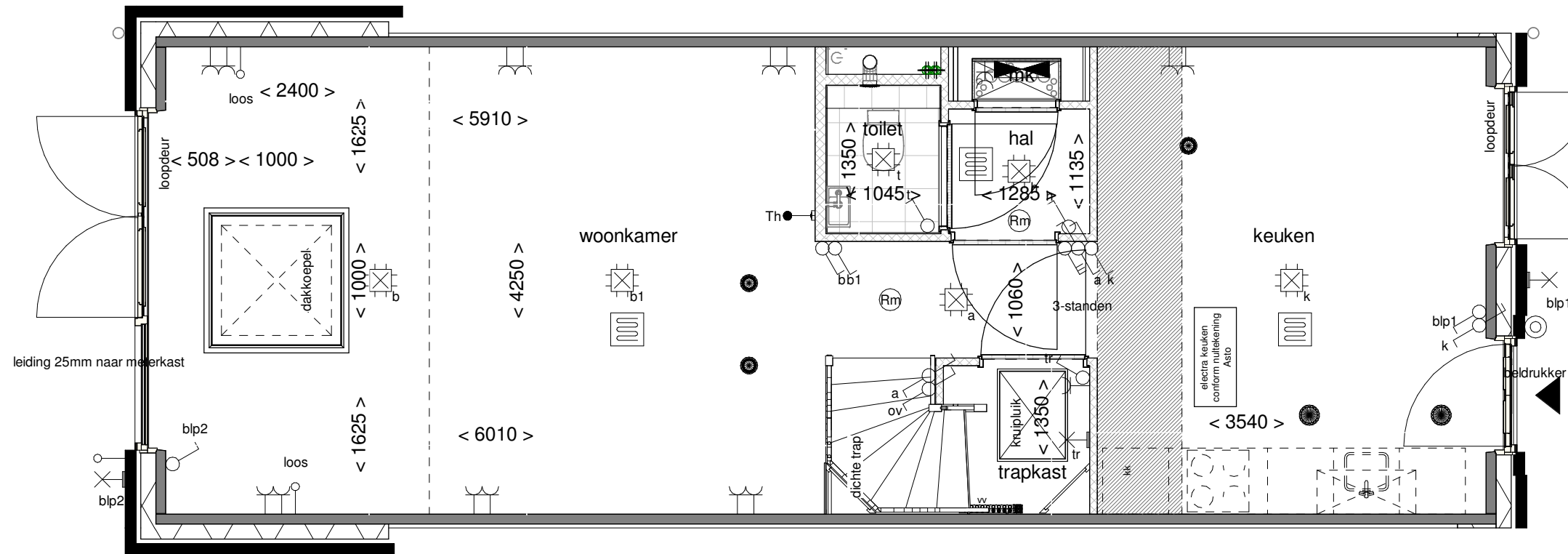

Doorsnede schaal 1:100

**ALLEMAAL
YIELEYAAL**

Optie: Lichtkoopeel in uitbouw 2400mm

Woningtype: Y45

Bouwnummer: -

Optienummer: 1.B.X.10

Schaal: 1:50 / 1:100

Datum: 29-09-2021

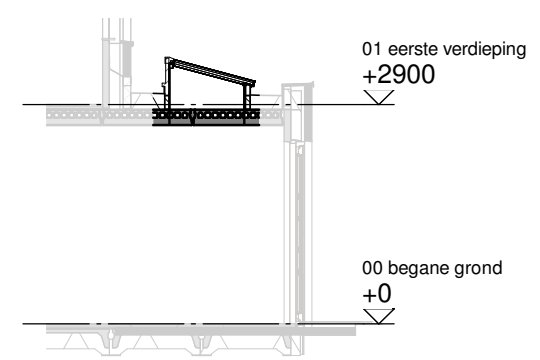
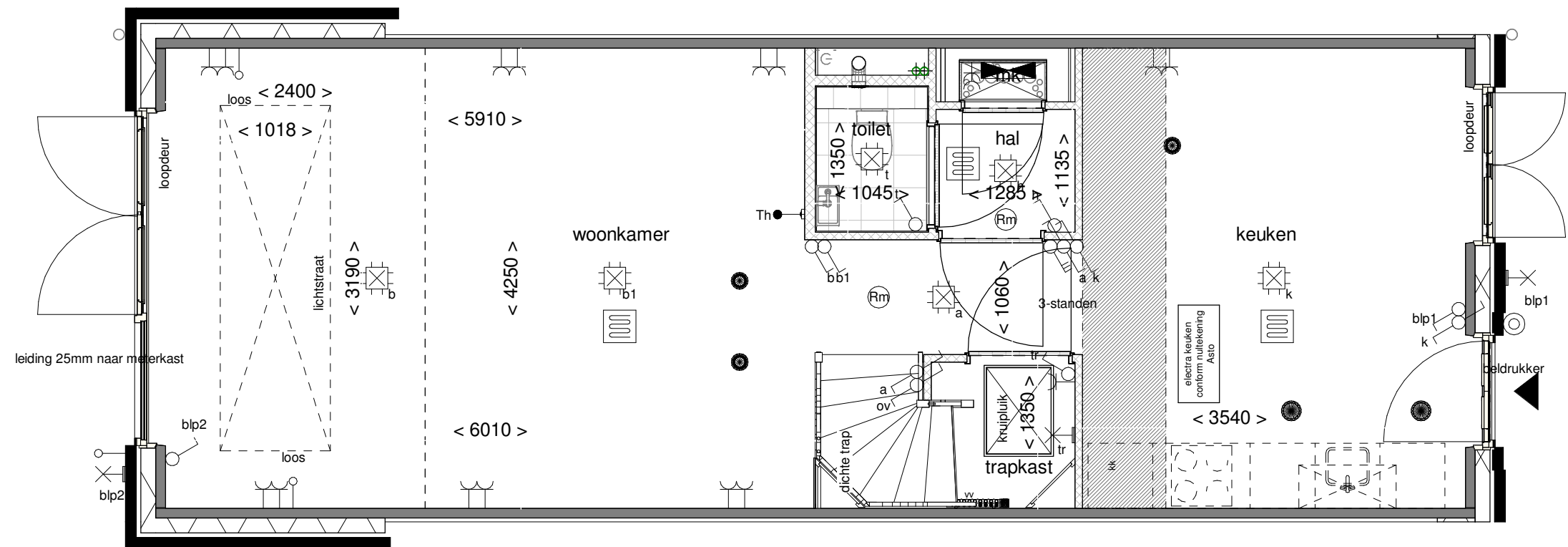

Doorsnede schaal 1:100

**ALLEMAAL
YIELEYAAL**

Optie: Lichtstraat in uitbouw
2400mm

Woningtype: Y45

Bouwnummer: -

Optienummer: 1.B.X.14

Schaal: 1:50 / 1:100

Datum: 29-09-2021

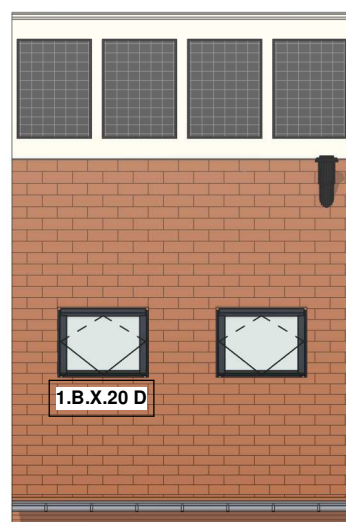
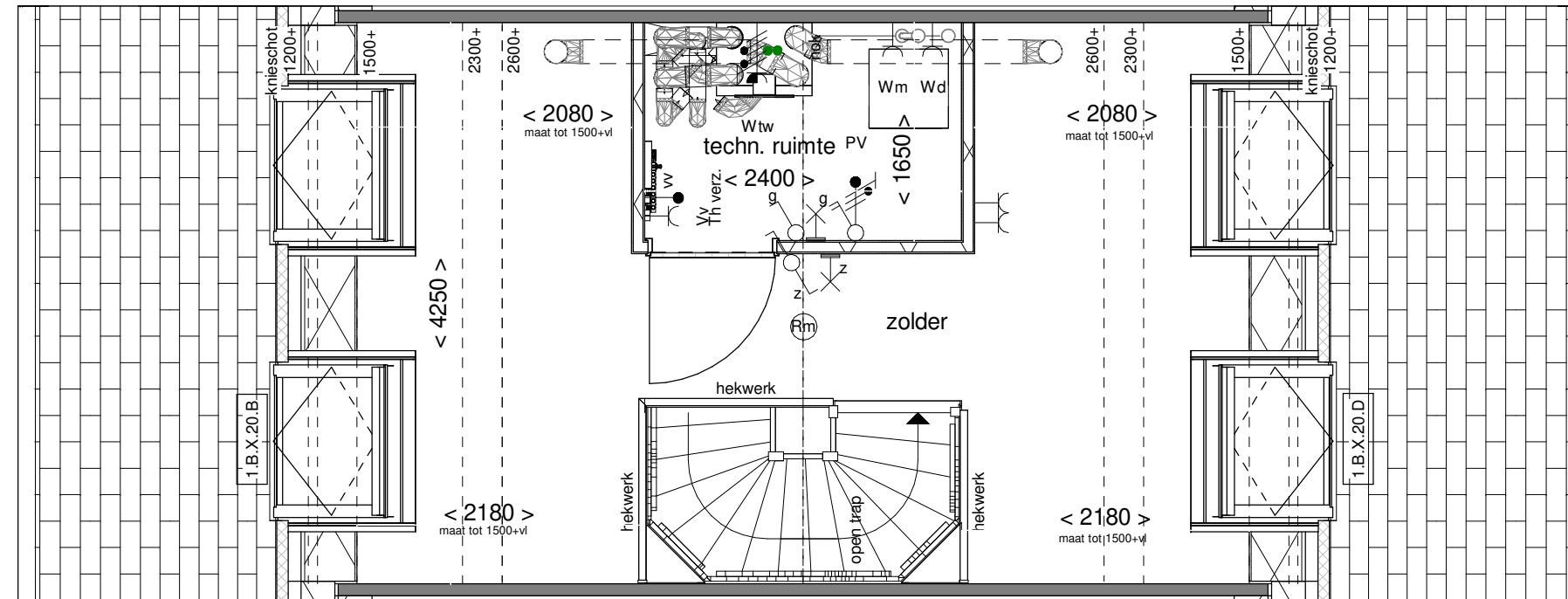

Voorgevel schaal 1:100

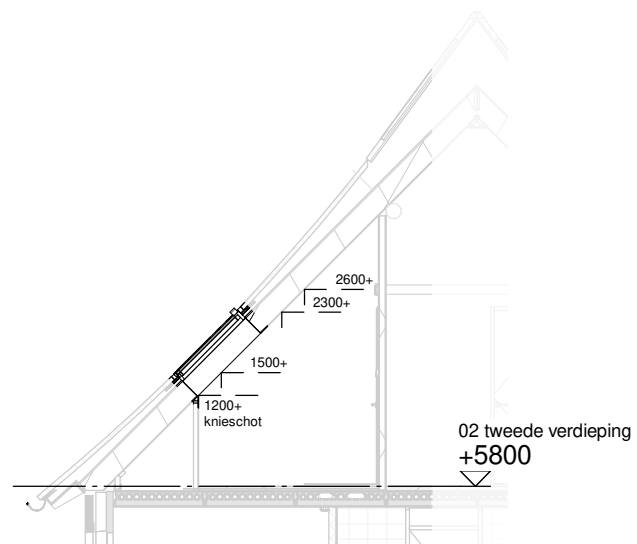

Doorsnede schaal 1:100

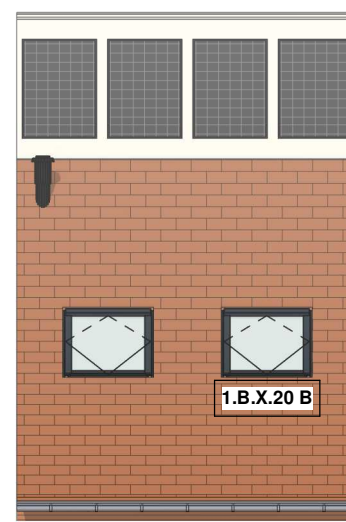

Achtergevel schaal 1:100

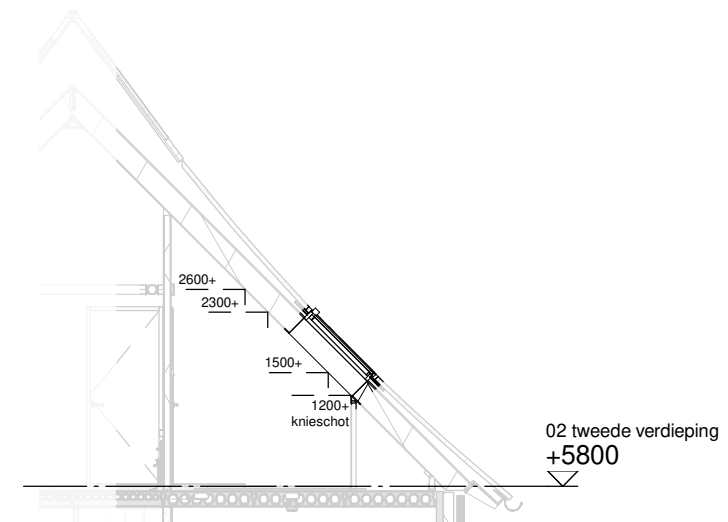

Doorsnede schaal 1:100

**ALLEMAAL
YIELEYAAL**

Optie: Dakramen voor- en achtergevel

Woningtype: Y45

Bouwnummer: -

Optienummer: 1.B.X.20

Schaal: 1:50 / 1:100

Datum: 29-09-2021

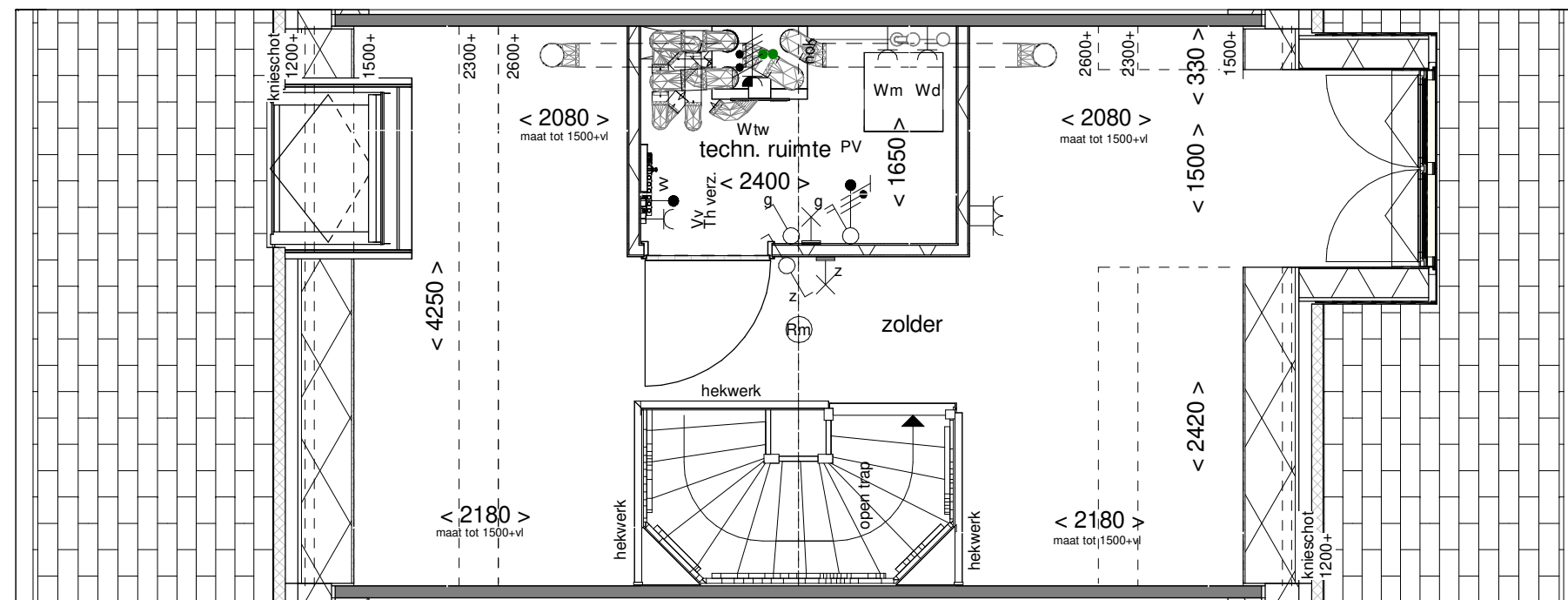

Voorgevel schaal 1:100

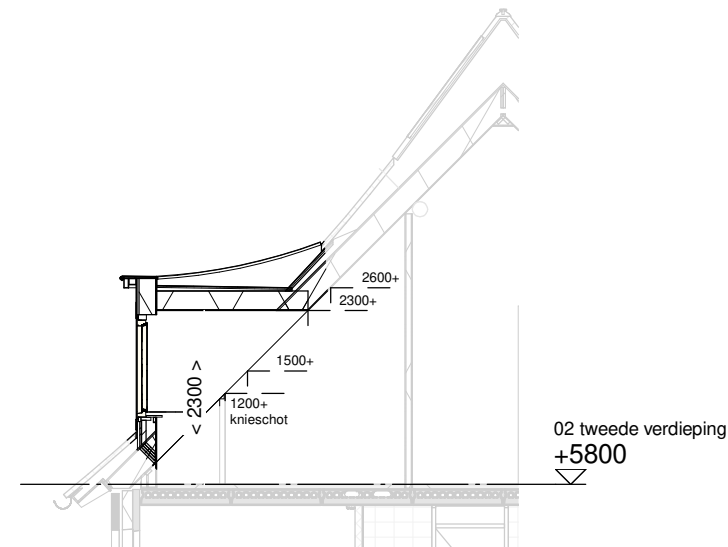

Doorsnede schaal 1:100

**ALLEMAAL
YIELEYAAL**

Optie: Dakkapel
voorgevel 1500mm

Woningtype: Y45

Bouwnummer: -

Optienummer: 1.B.X.33

Schaal: 1:50 / 1:100

Datum: 29-09-2021

02 tweede verdieping
+5800

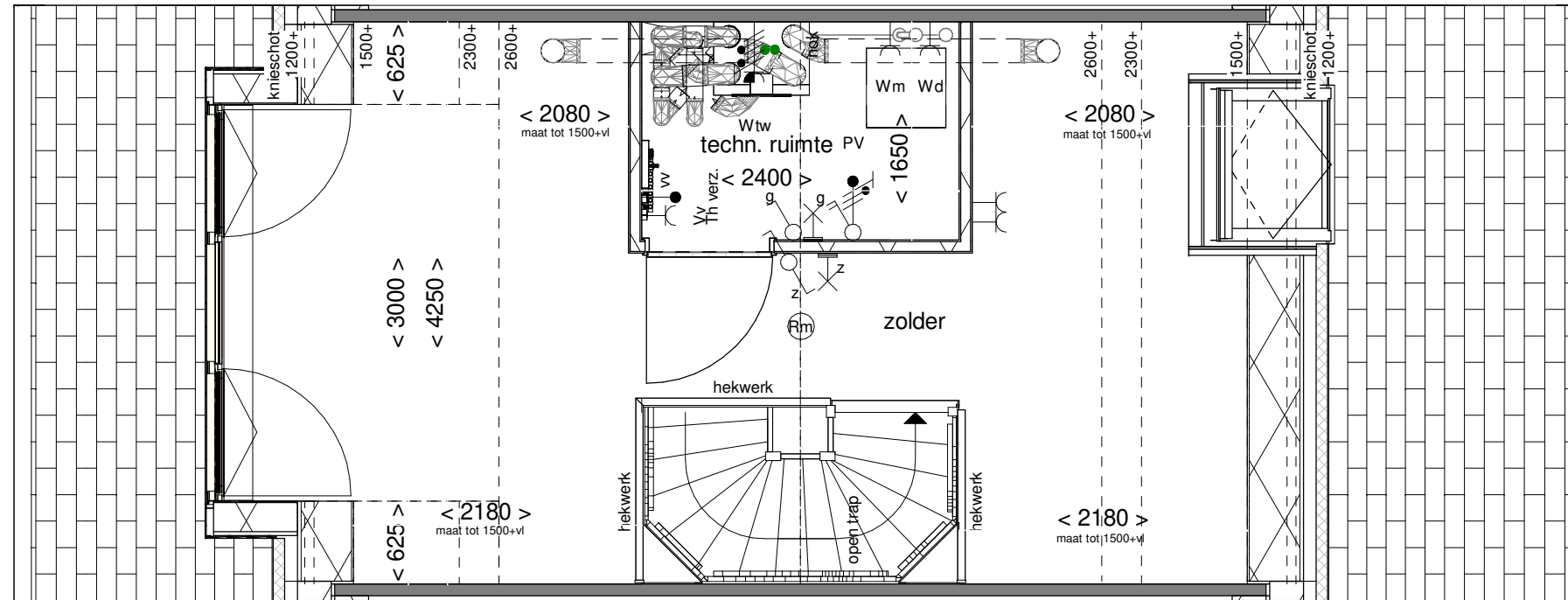

Achtergevel schaal 1:100

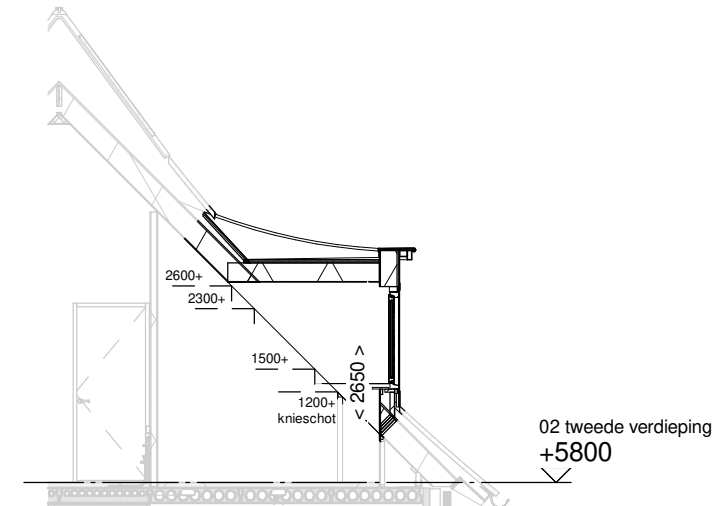

Achtergevel schaal 1:100

**ALLEMAAL
YIELEYAAL**

Optie: Dakkapel
achtergevel 3000mm

Woningtype: Y45

Bouwnummer: -

Optienummer: 1.B.X.34

Schaal: 1:50 / 1:100

Datum: 29-09-2021

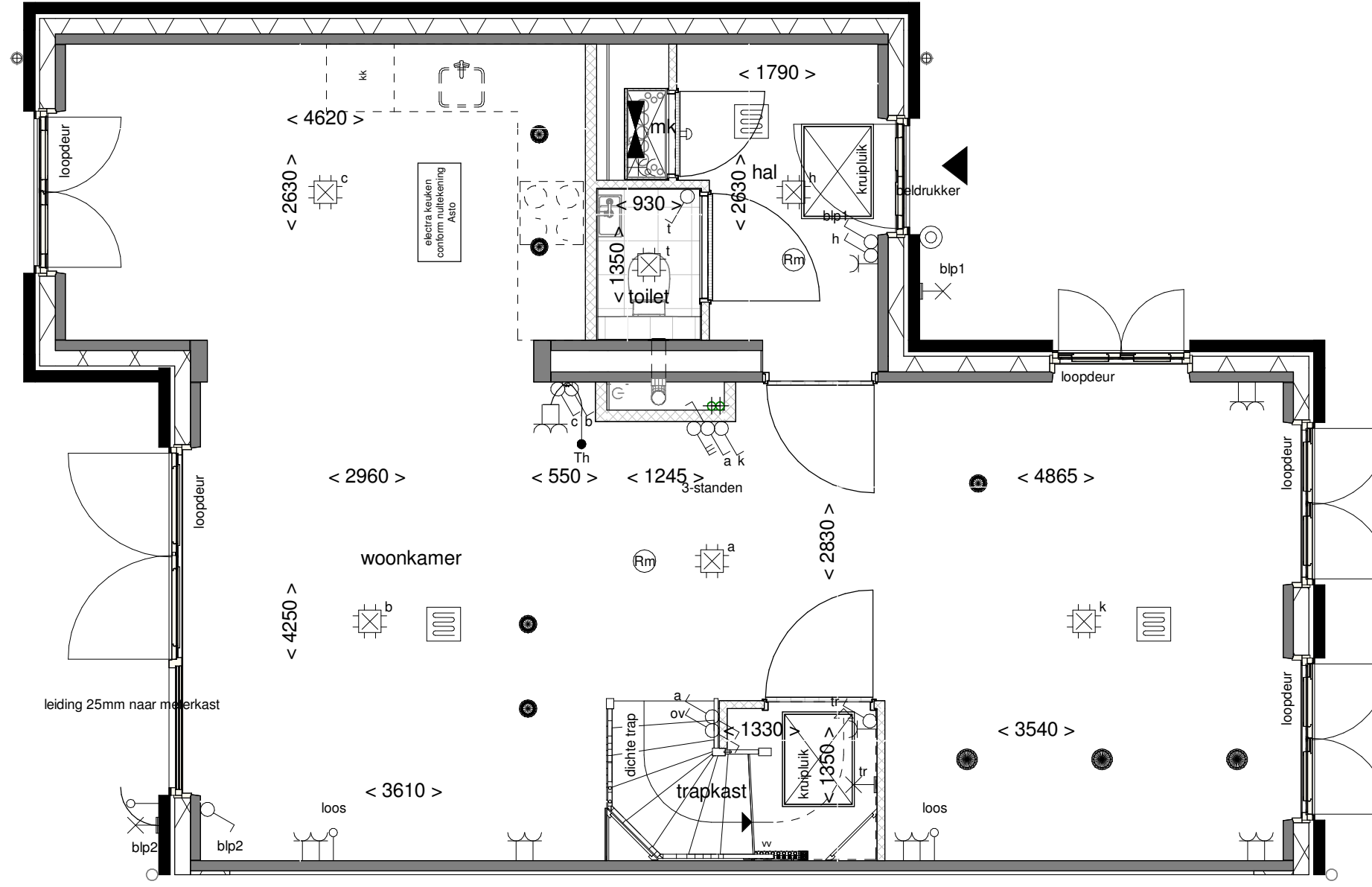

**ALLEMAAL
YIELEYAAL**

Optie: Keuken in zij-uitbouw

Woningtype: Y45U

Bouwnummer: -

Optienummer: 1.C.Y.12

Schaal: 1:50

Datum: 29-09-2021

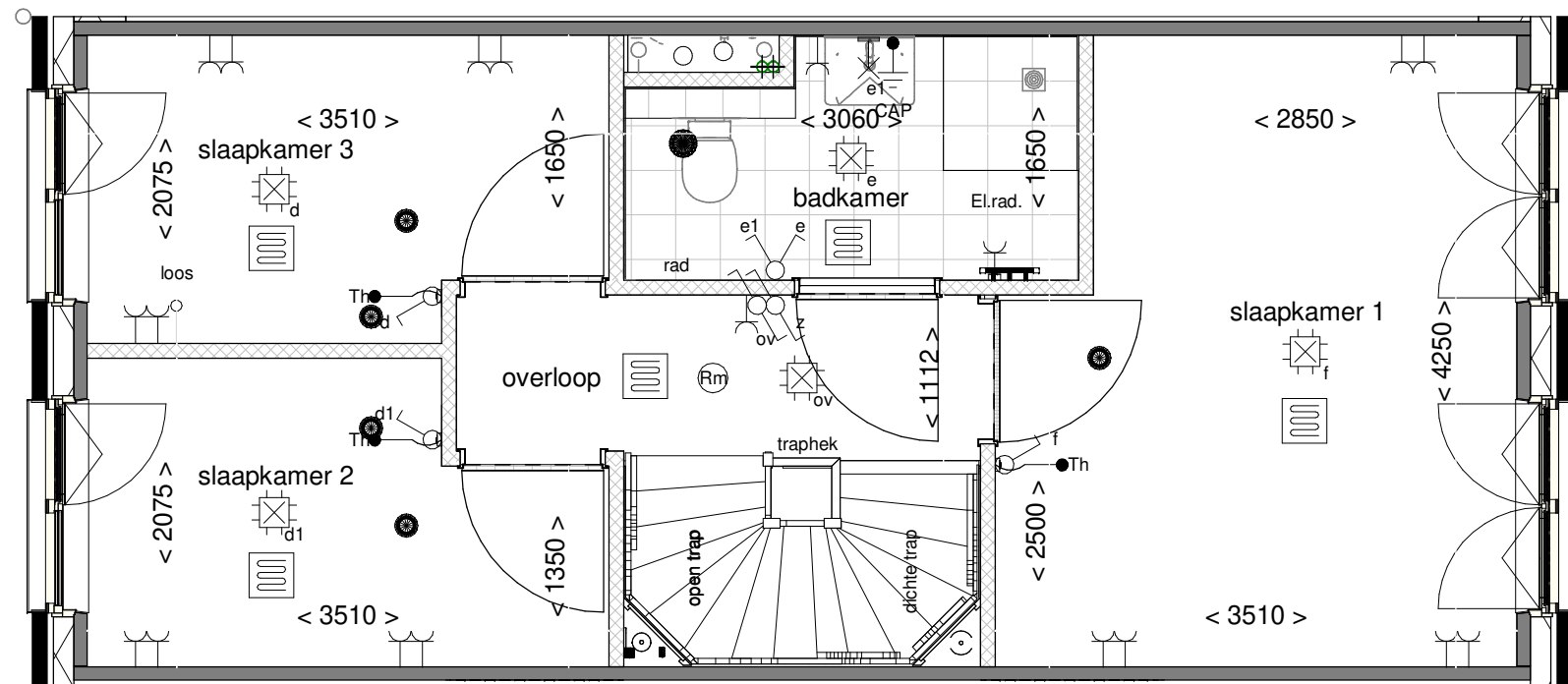

**ALLEMAAL
YIELEYAAL**

Optie: Twee slaapkamers
achterzijde

Woningtype: Y45

Bouwnummer: -

Optienummer: 1.C.Y.36

Schaal: 1:50

Datum: 29-09-2021

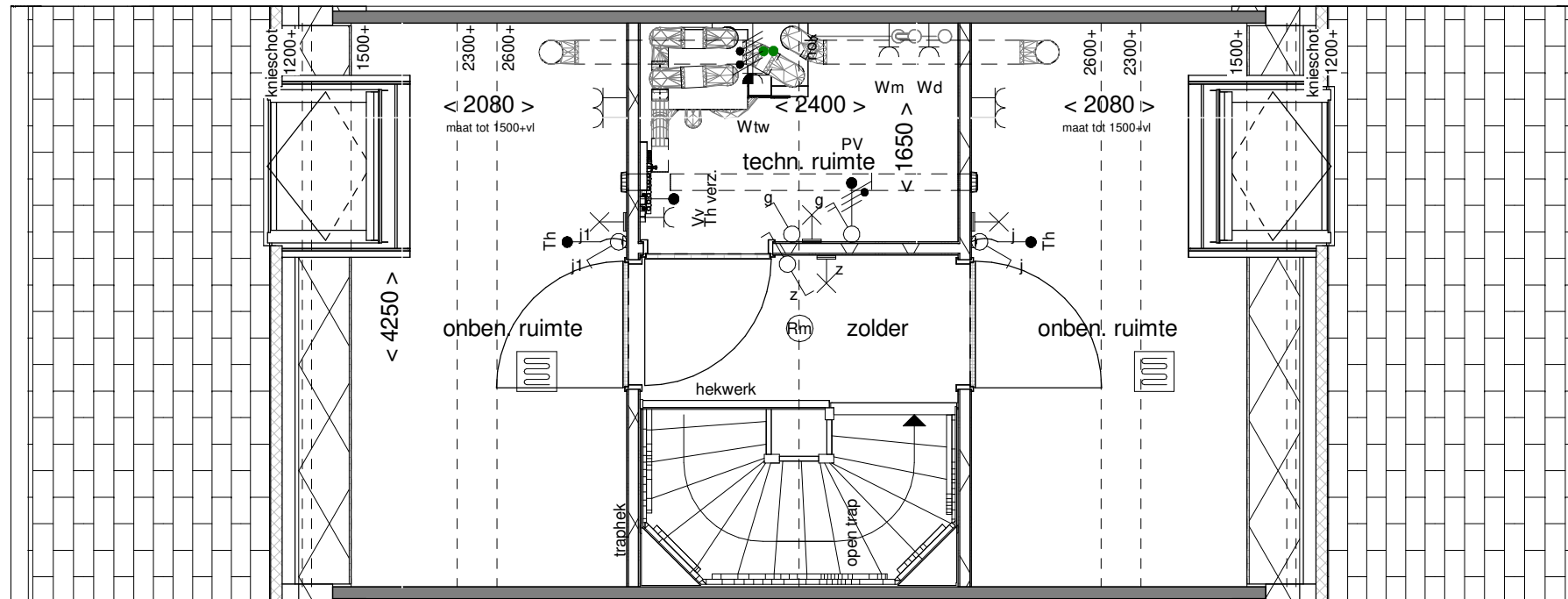

**ALLEMAAL
YIELEYAAL**

Optie: Indeling techn.- en
2 onb. ruimtes

Woningtype: Y45

Bouwnummer: -

Optienummer: 1.C.Y.76

Schaal: 1:50

Datum: 29-09-2021