

**ALLEMAAL
YIELEYAAL**

Tekening: **Situatie totaal**

Woningtype:

Bouwnummer:

Bladnummer: **VT-S-01**

Schaal: **1:1000**

Datum: **27-10-2021**

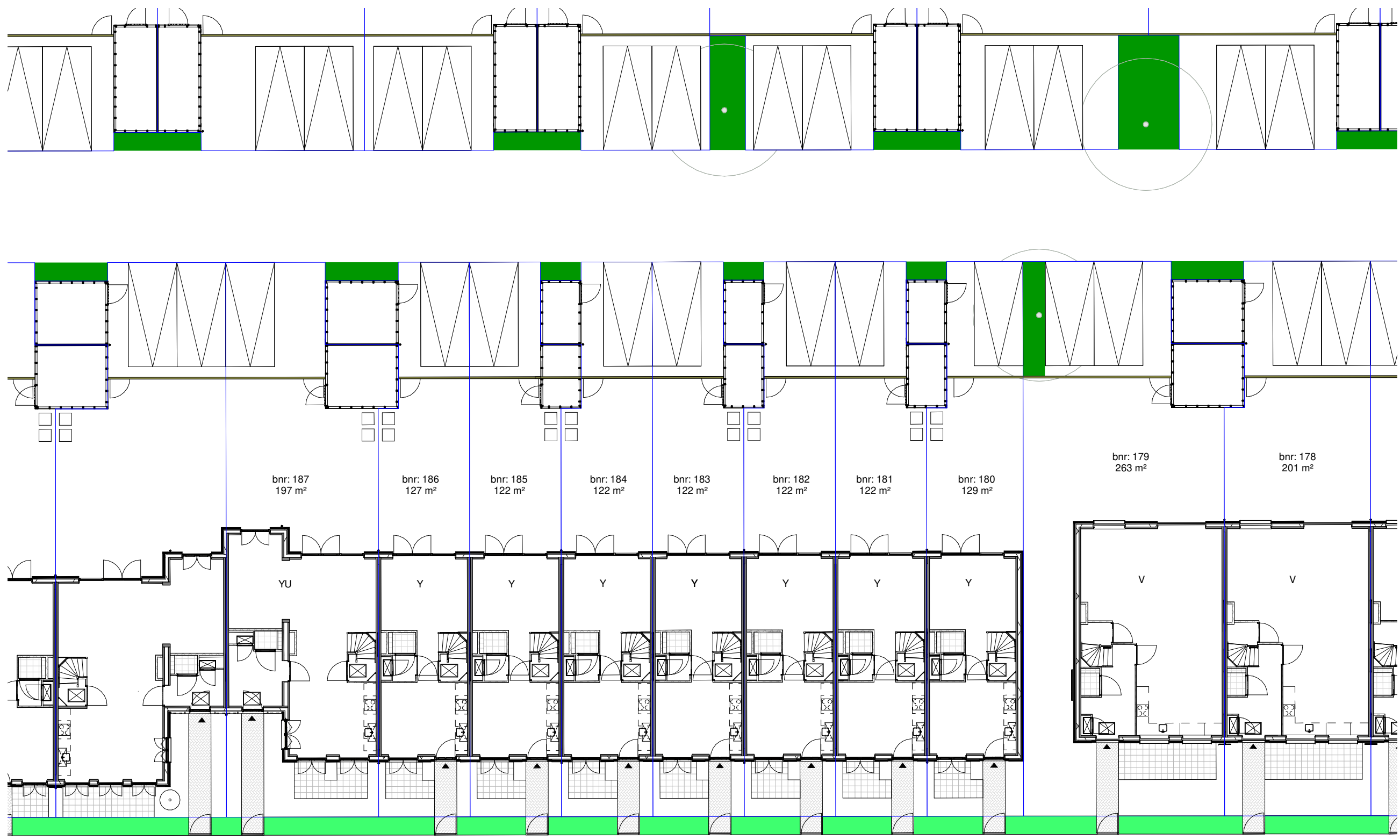

Renvooi

-  - entree woning
-  - parkeervak eigen terrein
-  - erfgrans
-  - beplanting type n.t.b. koper
-  - opstelplaats klike
-  - tuinhekje
-  - klinkerbestrating
-  - betontegels 300x300mm
-  - groen strook
-  - haag h=900mm
-  - haag h=1800mm
-  - bamboehok h=1800mm
-  - gaashek met klimplanten en poort h=1600mm

parkeerplekken en posities bomen en struiken zijn indicatief

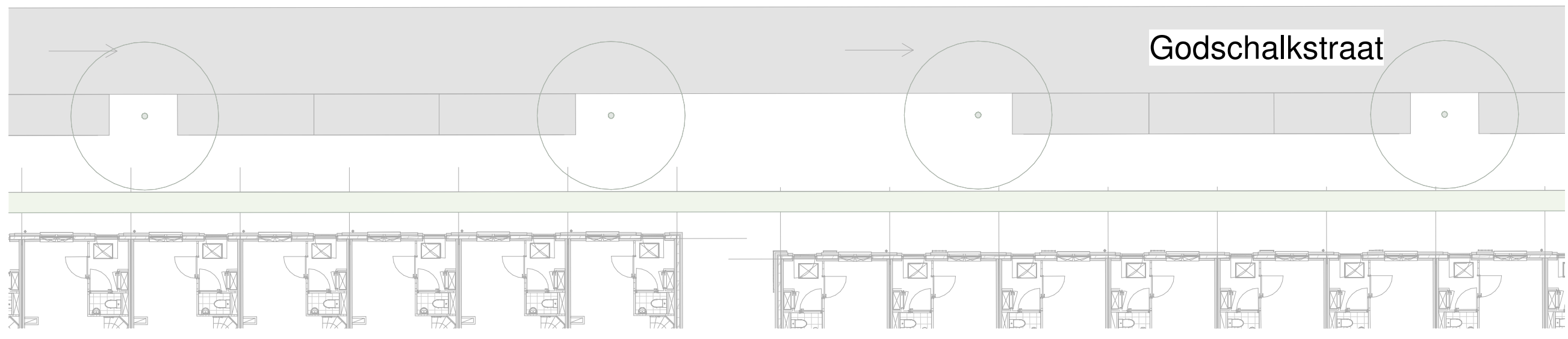











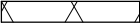

Godschalkstraat



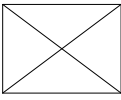

























**ALLEMAAL
YIELEYAAL**

| | |
|-------------|------------------|
| Tekening: | Situatie Blok I2 |
| Woningtype: | Y, YU |
| Bouwnummer: | 180-187 |
| Bladnummer: | VT-S-15 |
| Schaal: | 1:200 |
| Datum: | 27-10-2021 |

Renvooi bouwkundig

| | |
|---|-----------------------------------|
|  | metselwerk kleur A |
|  | dakpannen kleur oranje |
|  | entree woning |
|  | metselwerk |
|  | isolatie |
|  | dragende wand |
|  | niet dragende binnenwand |
|  | binnendeurkozijn (met bovenlicht) |
|  | kruipluik |
|  | opstelplaats wasmachine |
|  | opstelplaats wasdroger |
|  | |
|  | principe opstelling keukenblok |

Renvooi installaties

| | |
|---|---|
|  | aansluitpunt licht |
|  | aansluitpunt licht, wand |
|  | centraaldoos met lichtpunt |
|  | armatuur aan de wand |
|  | rookmelder |
|  | aansluitpunt niet bedraad |
|  | verdeelinrichting / meterkast / groepenkast |
|  | beldrukker |
|  | schel |
|  | schakelaar, 1-polig |
|  | werkschakelaar tbv PV-panelen |
|  | schakelaar, 3-polig |
|  | schakelaar, wissel |
|  | schakelaar, kruis |
|  | schakelaar, serie |
|  | wandcontactdoos 1-voudig met beschermingscontact |
|  | wandcontactdoos 2-voudig met beschermingscontact, verticaal |
|  | wandcontactdoos 2-voudig met beschermingscontact |
|  | thermostaatleiding, bedraad |
|  | mechanische ventilatie-unit incl. warmteterugwinunit |
|  | warmtepomp |
|  | inblaasventiel mechanische ventilatie |
|  | uitblaasventiel mechanische ventilatie |
|  | verdeler vloerverwarming |
|  | ruimte voorzien van vloerverwarming |
|  | elektrische radiator |
|  | kanalen in het zicht |
|  | onbenoemde ruimte volgens krijtstreepmethode |

Disclaimer

De op deze tekeningen aangegeven maten zijn circa maten in millimeters en tussen de wanden / vloeren gemeten, waarbij geen rekening is gehouden met enige wandafwerking, plinten, aftimmering, ect. In verband met de nauwkeurige uitwerking van details, constructie, maatvoering, materialen e.d. kunnen er kleine afwijkingen ontstaan ten opzichte van de nu vermelde gegevens. Deze geringe afwijkingen geven geen aanleiding tot verrekening. Aan de op deze tekening aangegeven maten kunnen derhalve geen rechten worden ontleend. De op deze tekeningen aangegeven maatvoering is niet geschikt voor opdrachten aan derden door koper(s). De posities van aansluitingen en installatie onderdelen zijn indicatief op tekening aangegeven. De exacte aantallen en posities zullen na berekening in het werk door de installateurs worden bepaald en kunnen afwijken van deze tekening.

**ALLEMAAL
YIELEYAAL**

Tekening: Renvooi

Woningtype: -

Bouwnummer: -

Bladnummer: VT-0-00c

Schaal: -

Datum: 27-10-2021



Type: YU
bwnr: 187

Type: Y
bwnr: 186

Type: Y
bwnr: 185

Type: Y
bwnr: 184

Type: Y
bwnr: 183

Type: Y
bwnr: 182

Type: Y
bwnr: 181

Type: Y
bwnr: 180



Type: Y
bwnr: 180

Type: Y
bwnr: 181

Type: Y
bwnr: 182

Type: Y
bwnr: 183

Type: Y
bwnr: 184

Type: Y
bwnr: 185

Type: Y
bwnr: 186

Type: YU
bwnr: 187

ALLEMAAL
YIELEYAAL

Tekening: Gevels blok I2

Woningtype: Y, YU

Bouwnummer: 180 t/m 187

Bladnummer: VT-I2-00a

Schaal: 1:150

Datum: 27-10-2021

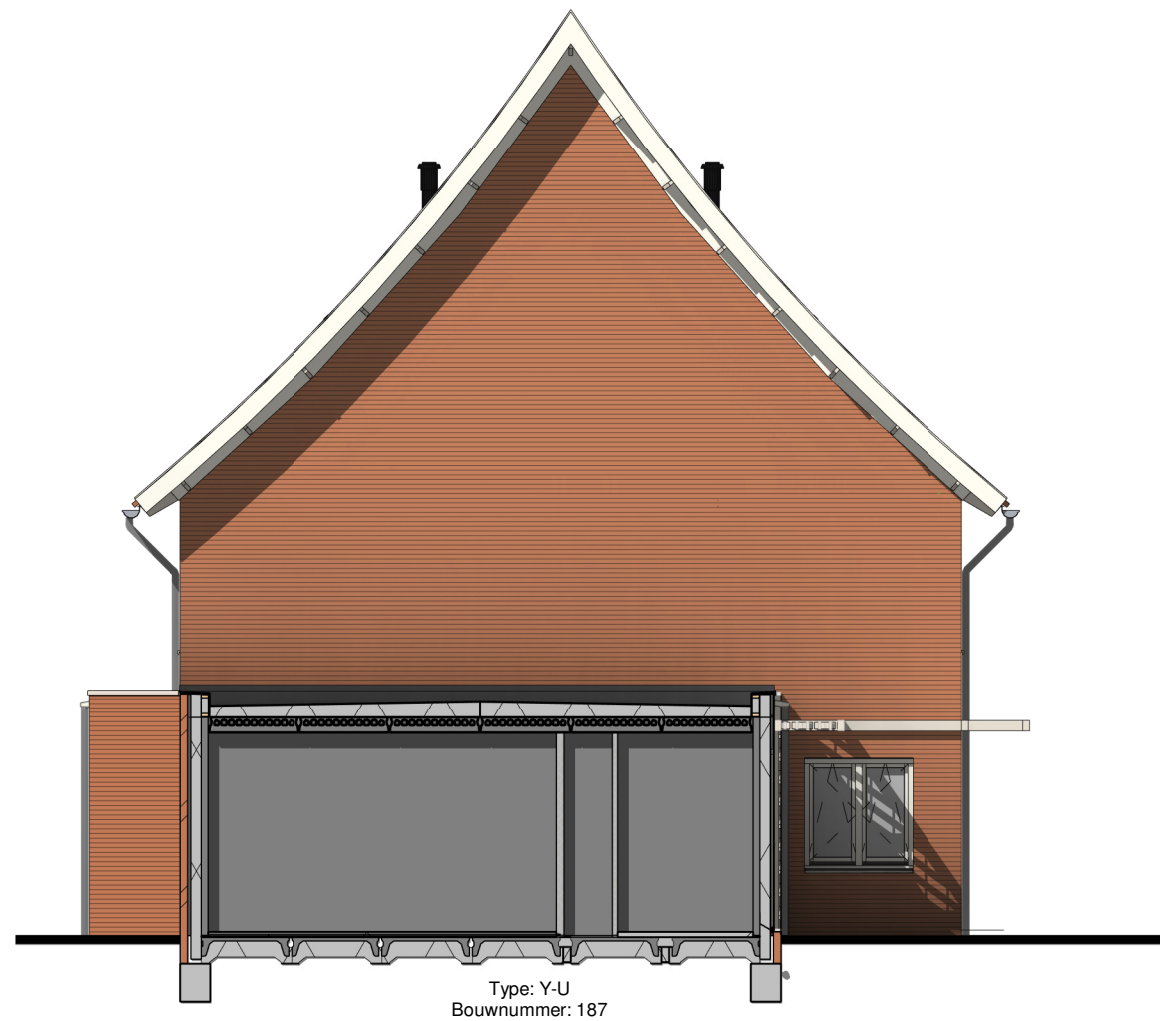

Linker zijgevel

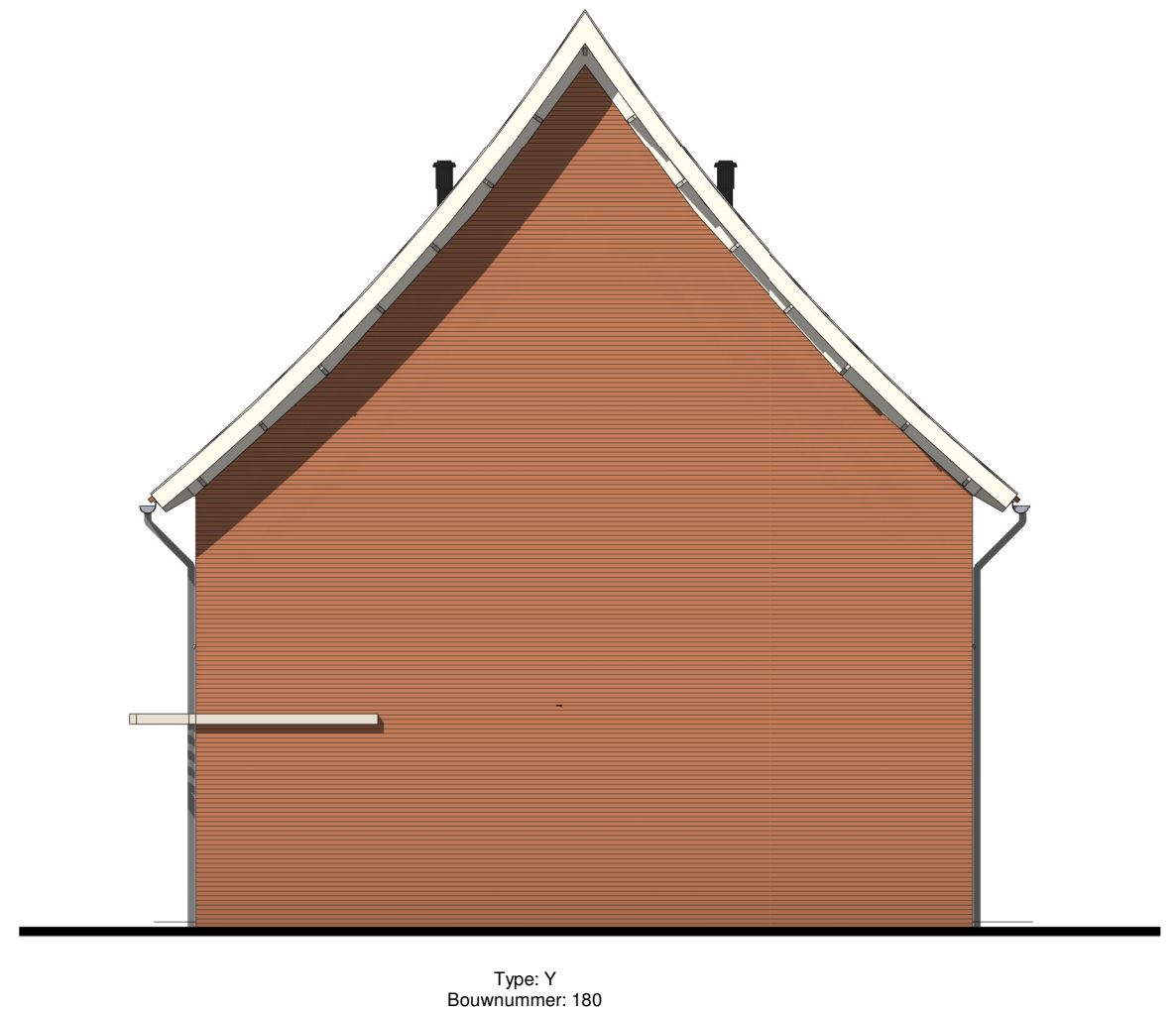

Rechter zijgevel

ALLEMAAL
YIELEYAAL

Tekening: Zijgevels blok I2

Woningtype: Y, Y-U

Bouwnummer: 180 t/m 187

Bladnummer: VT-I2-00b

Schaal: 1:100

Datum: 27-10-2021

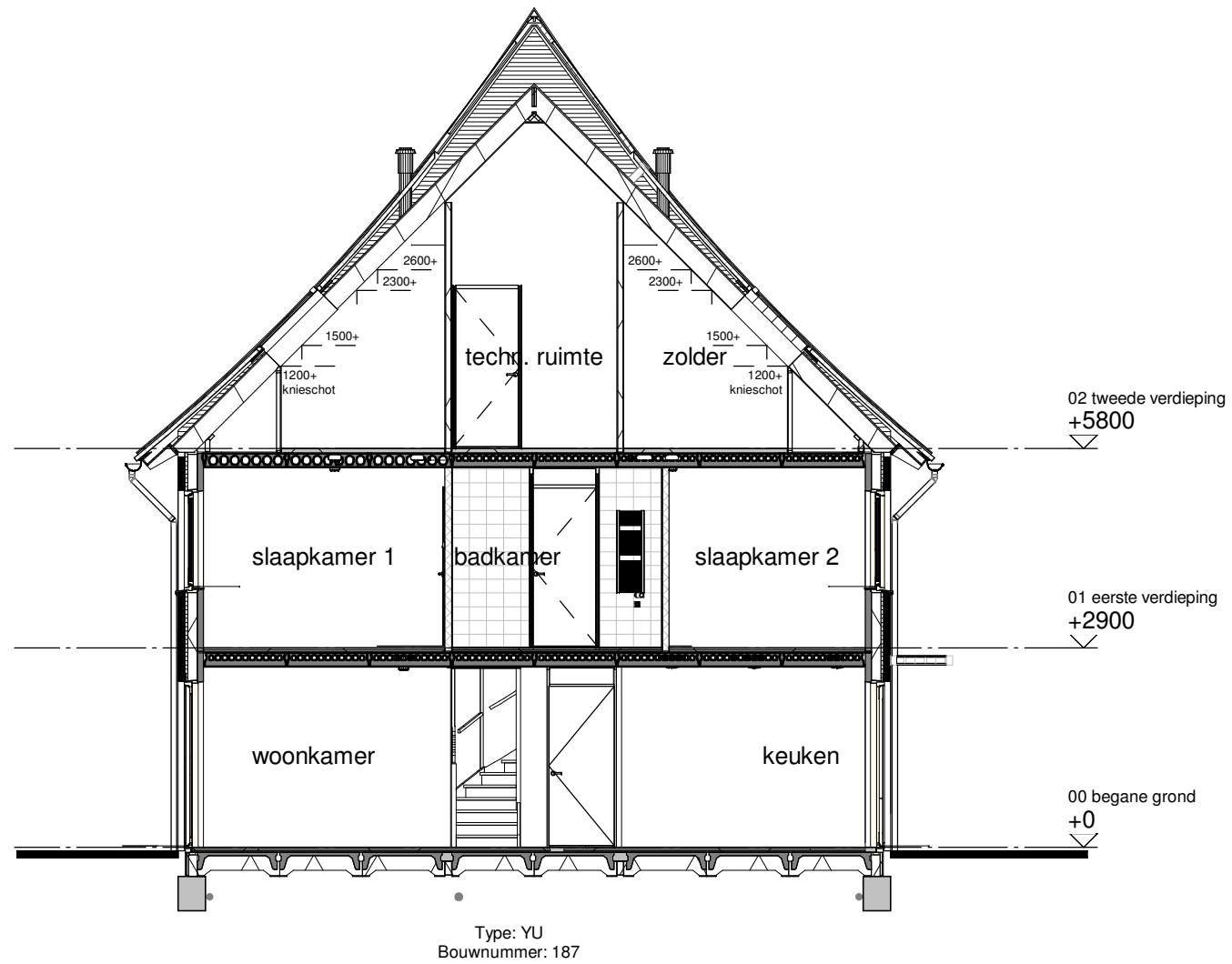

Doorsnede A

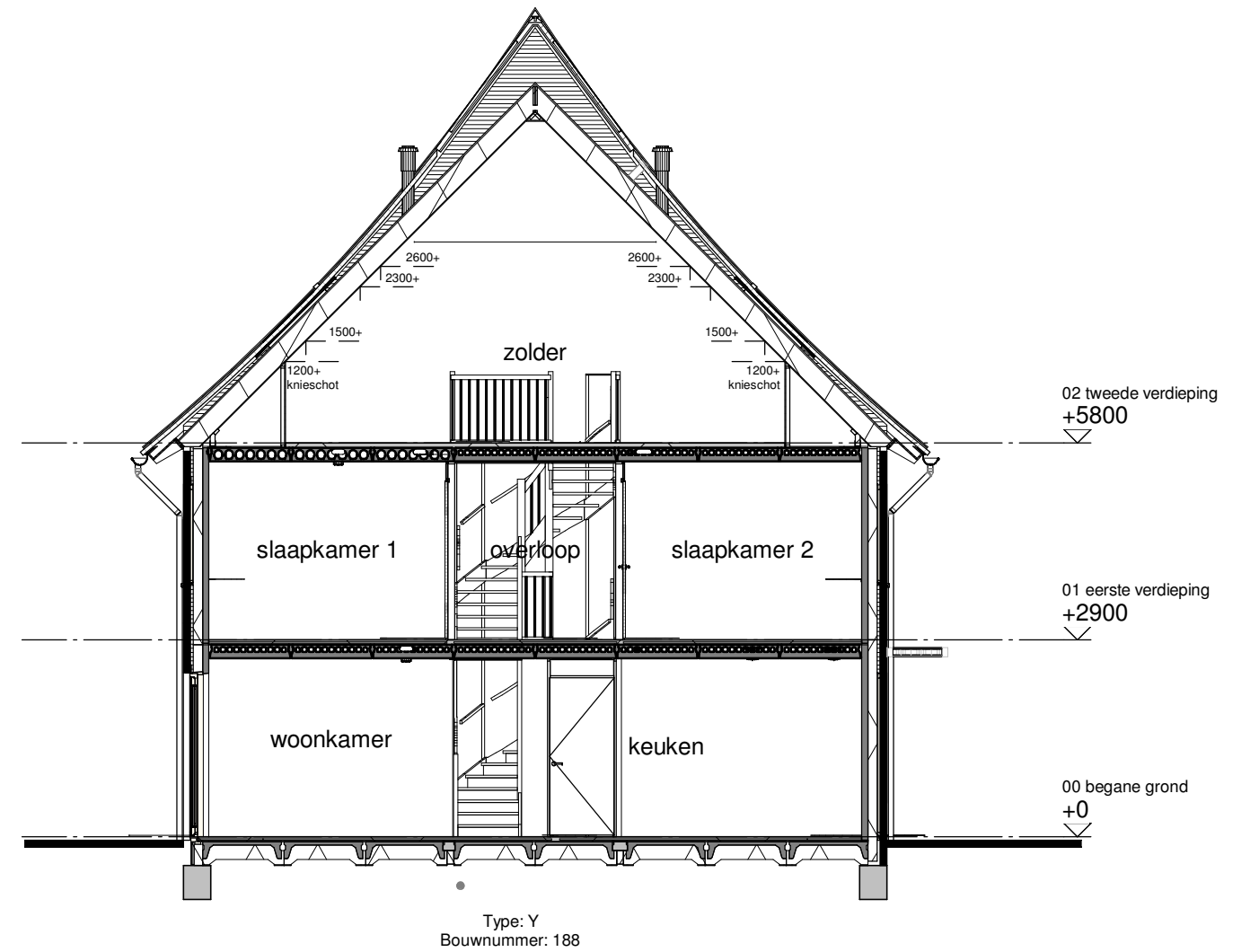

Doorsnede B

**ALLEMAAL
YIELEYAAL**

Tekening: Doorsnede blok I2

Woningtype: YU, Y

Bouwnummer: 180-187

Bladnummer: VT-I2-00c

Schaal: 1:100

Datum: 27-10-2021

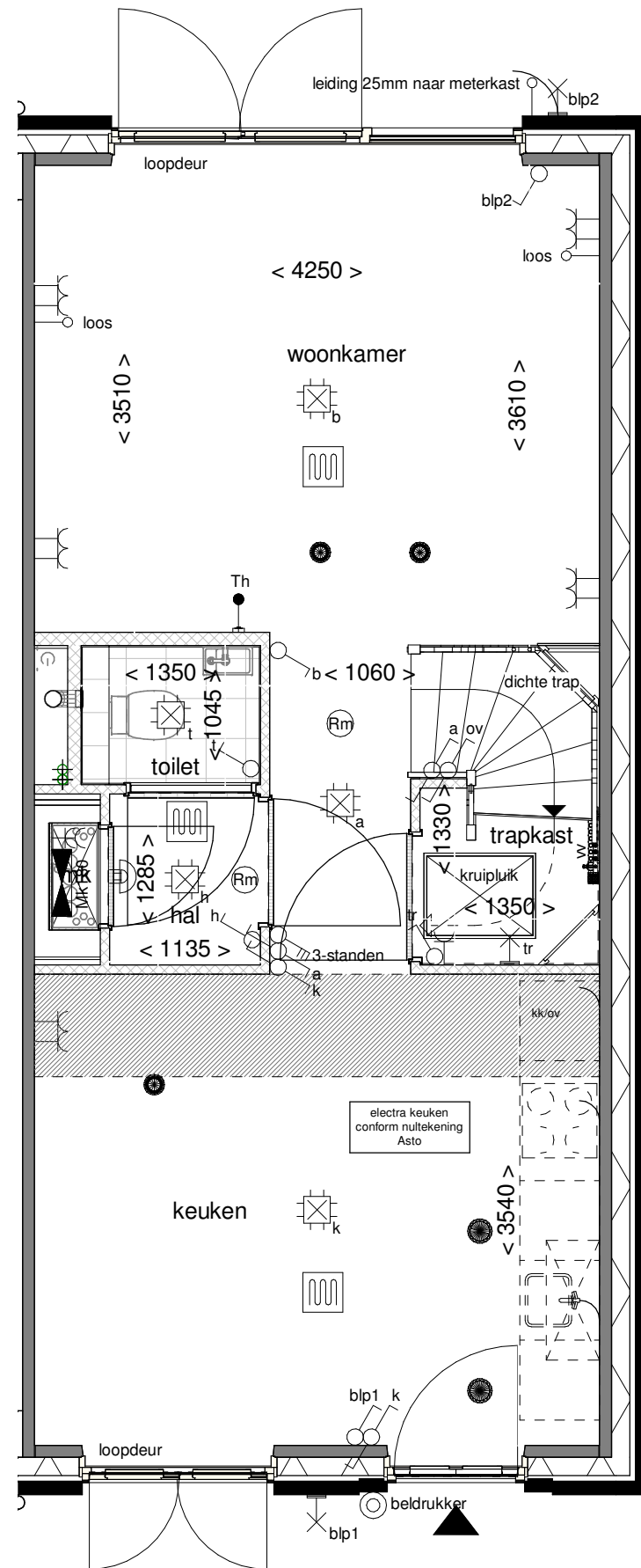

ALLEMAAL
YIELEYAAL

Tekening: Begane grond

Woningtype: Y

Bouwnummer: 180

Bladnummer: VT-I2-180a

Schaal: 1:50

Datum: 27-10-2021

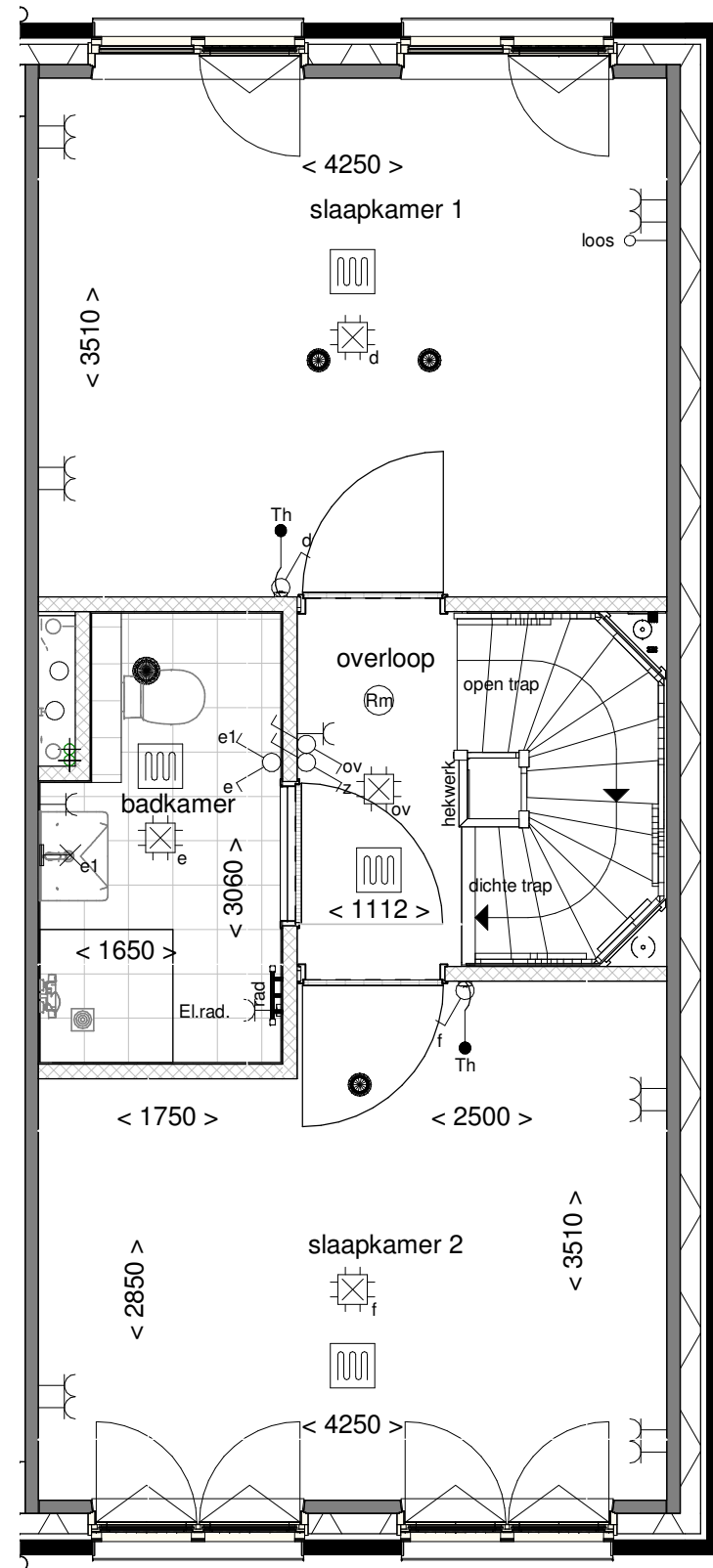

**ALLEMAAL
YIELEYAAL**

Tekening: Eerste verdieping

Woningtype: Y

Bouwnummer: 180

Bladnummer: VT-12-180b

Schaal: 1:50

Datum: 27-10-2021

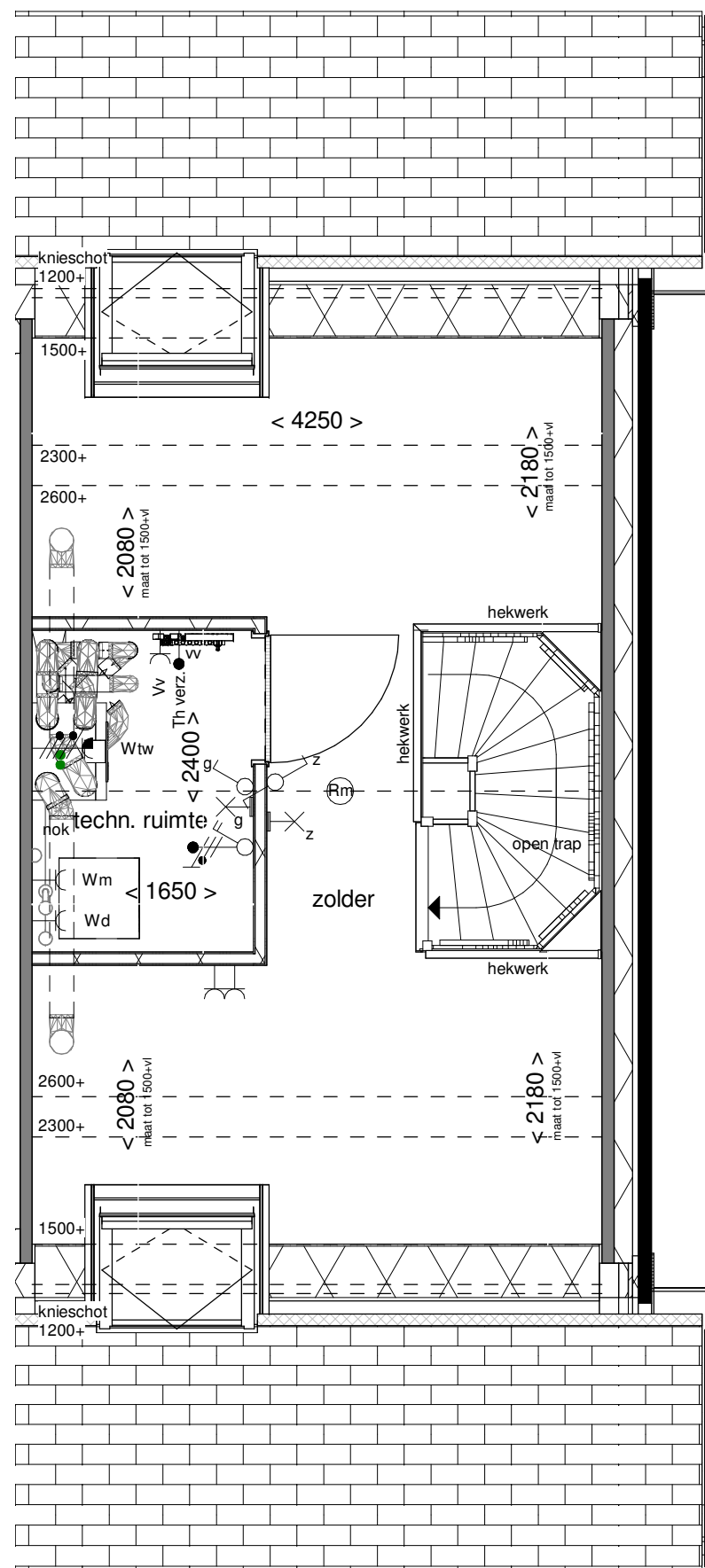

**ALLEMAAL
VIELEJAAR**

Tekening: Tweede verdieping

Woningtype: Y

Bouwnummer: 180

Bladnummer: VT-I2-180c

Schaal: 1:50

Datum: 27-10-2021

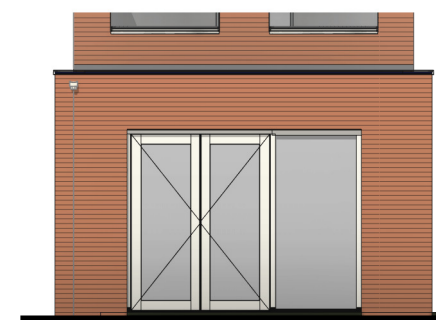
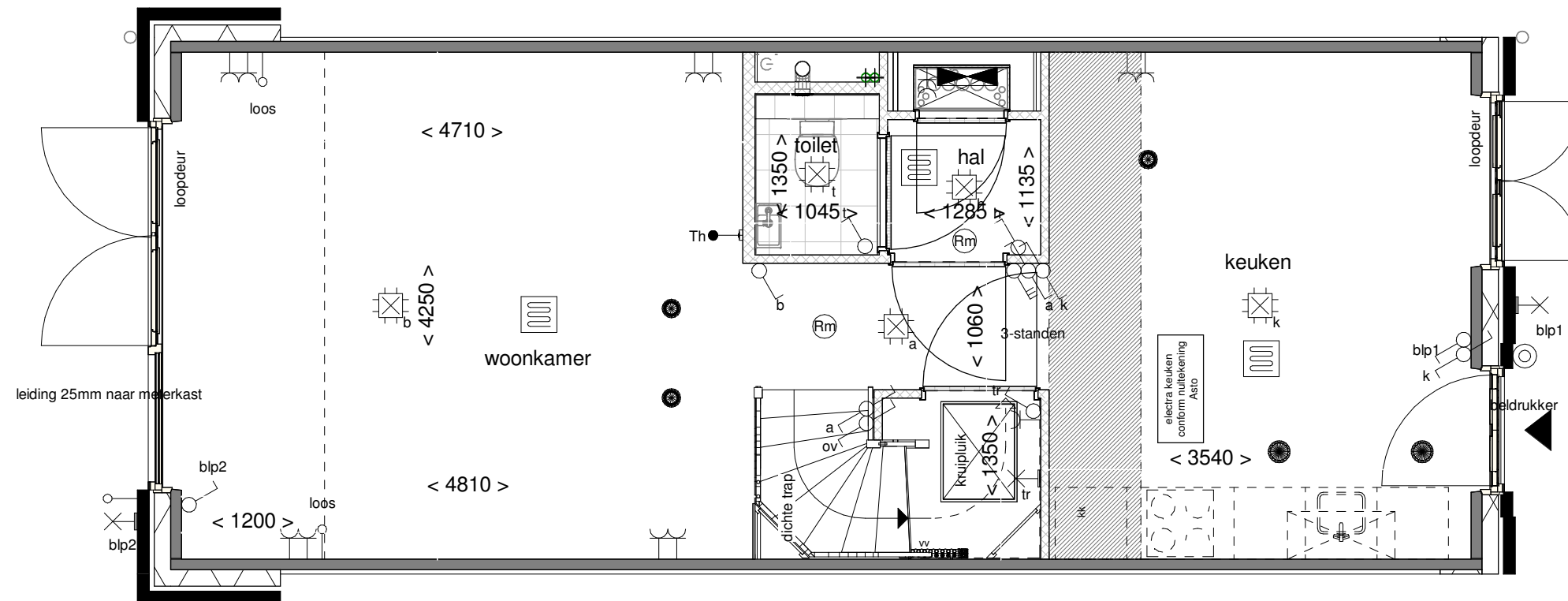

Achtergevel schaal 1:100

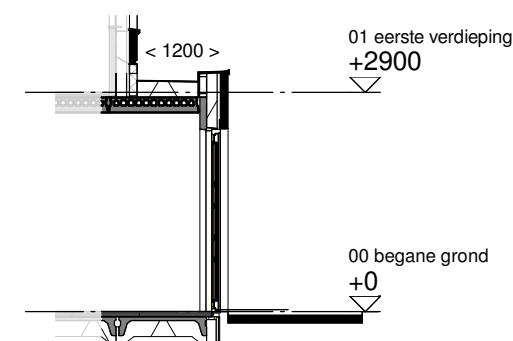

Doorsnede schaal 1:100

**ALLEMAAL
YIELEYAAL**

Optie: **Uitbouw achtergevel
1200mm**

Woningtype: **Y45**

Bouwnummer: -

Optienummer: **0.A.Y.14**

Schaal: **1:50 / 1:100**

Datum: **29-09-2021**

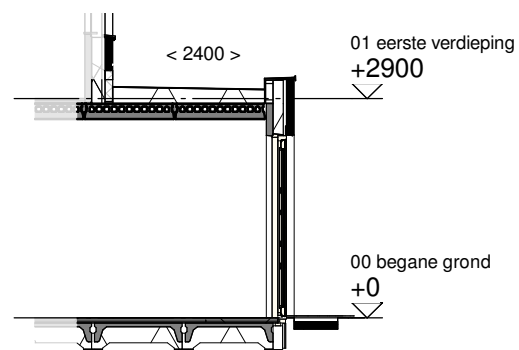
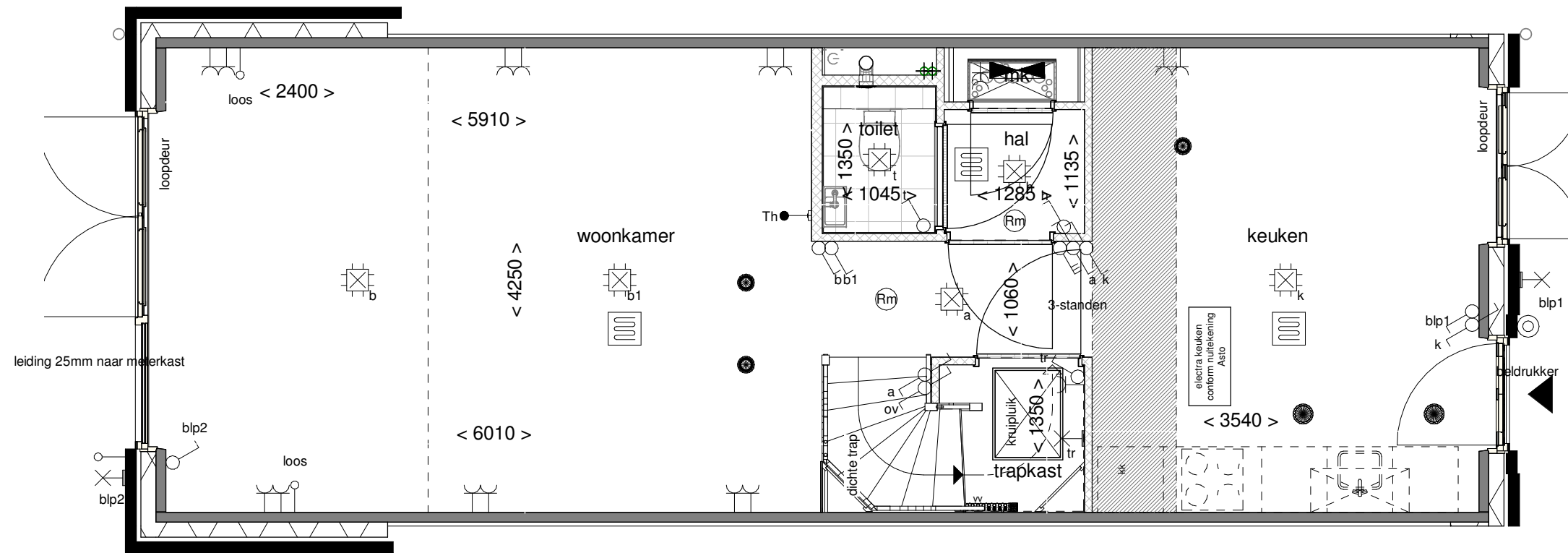

Doorsnede schaal 1:100

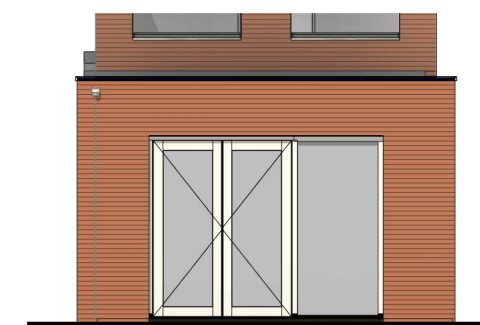

Achtergevel schaal 1:100

**ALLEMAAL
YIELEYAAL**

Optie: Uitbouw achtergevel
2400mm

Woningtype: Y45

Bouwnummer: -

Optienummer: 0.A.Y.34

Schaal: 1:50 / 1:100

Datum: 29-09-2021

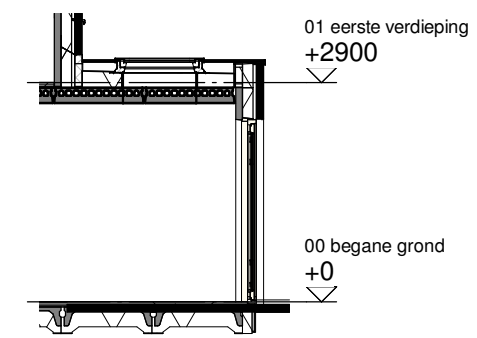
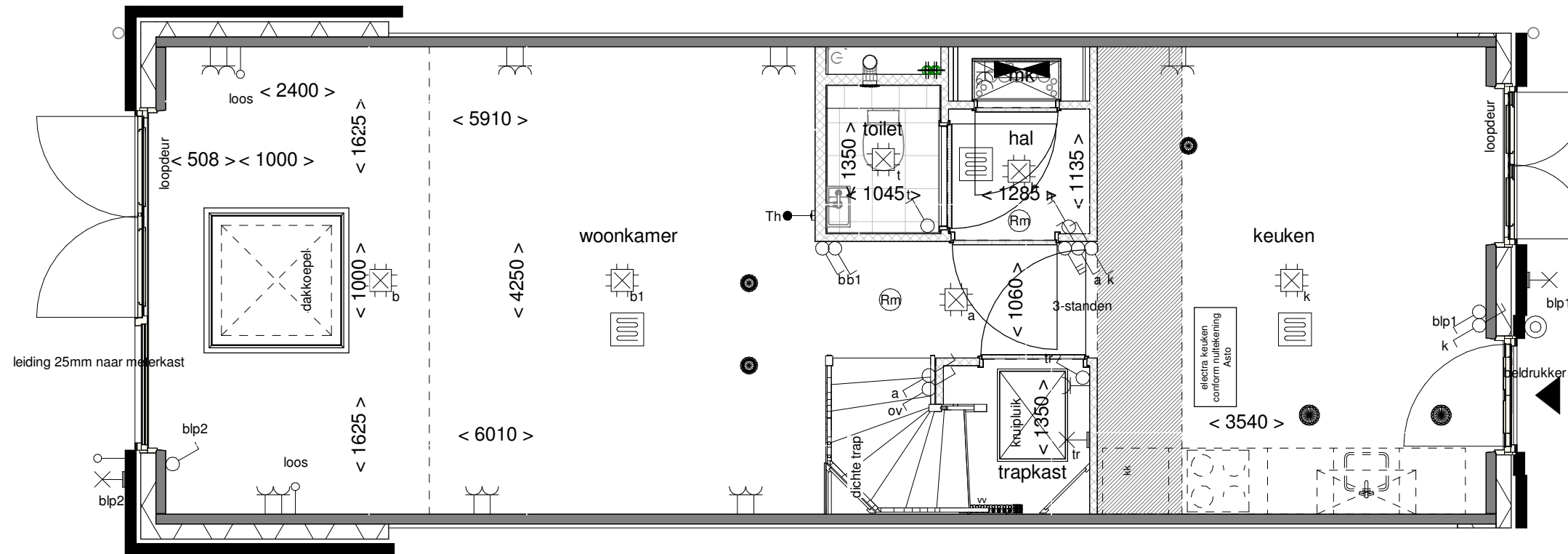

Doorsnede schaal 1:100

**ALLEMAAL
YIELEYAAL**

| | |
|--------------|--------------------------------|
| Optie: | Lichtkoopeel in uitbouw 2400mm |
| Woningtype: | Y45 |
| Bouwnummer: | - |
| Optienummer: | 1.B.X.10 |
| Schaal: | 1:50 / 1:100 |
| Datum: | 29-09-2021 |

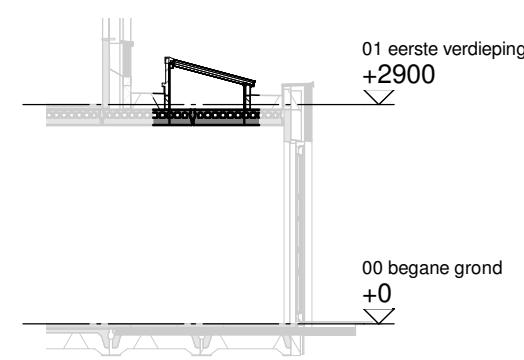
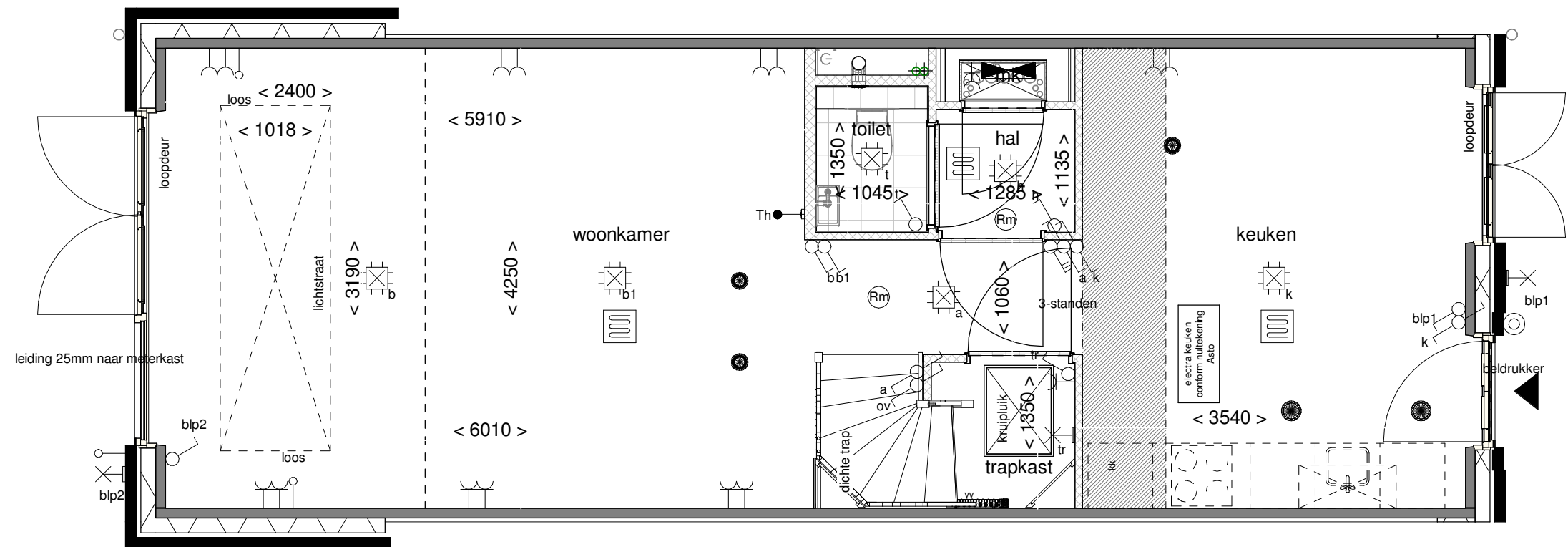

Doorsnede schaal 1:100

**ALLEMAAL
YIELEYAAL**

Optie: Lichtstraat in uitbouw
2400mm

Woningtype: Y45

Bouwnummer: -

Optienummer: 1.B.X.14

Schaal: 1:50 / 1:100

Datum: 29-09-2021

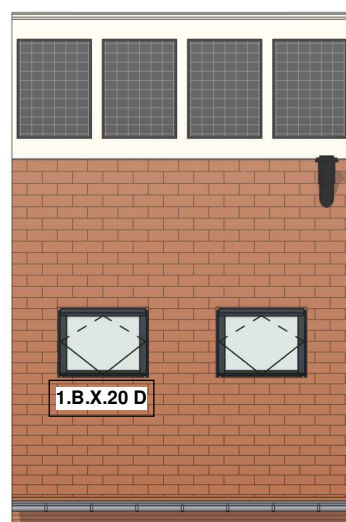
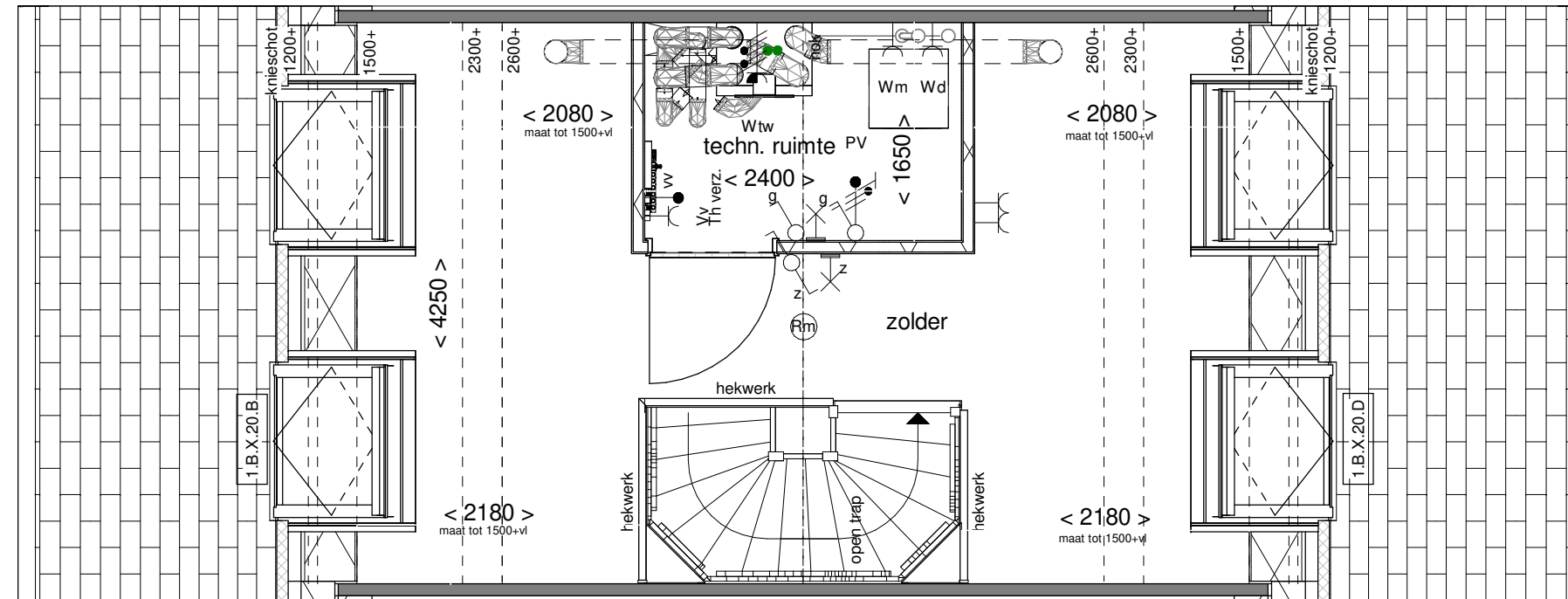

Voorgevel schaal 1:100

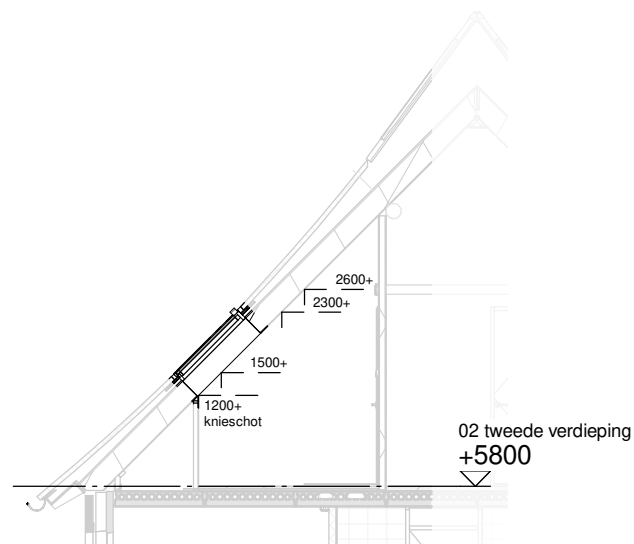

Doorsnede schaal 1:100

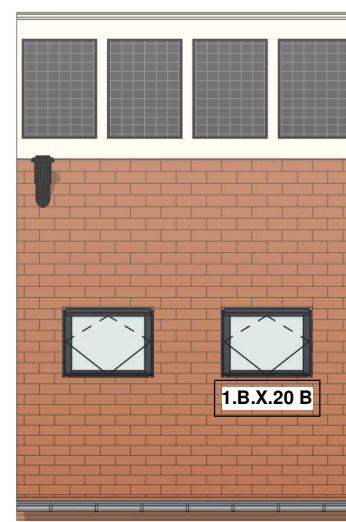

Achtergevel schaal 1:100

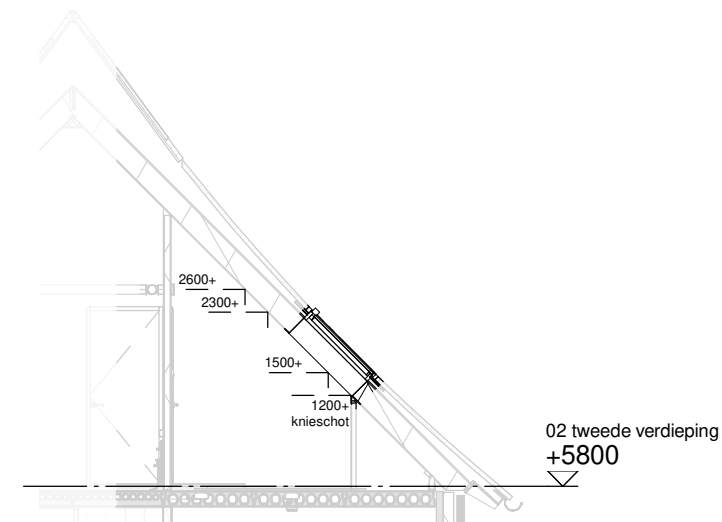

Doorsnede schaal 1:100

**ALLEMAAL
YIELEYAAL**

Optie: Dakramen voor- en achtergevel

Woningtype: Y45

Bouwnummer: -

Optienummer: 1.B.X.20

Schaal: 1:50 / 1:100

Datum: 29-09-2021

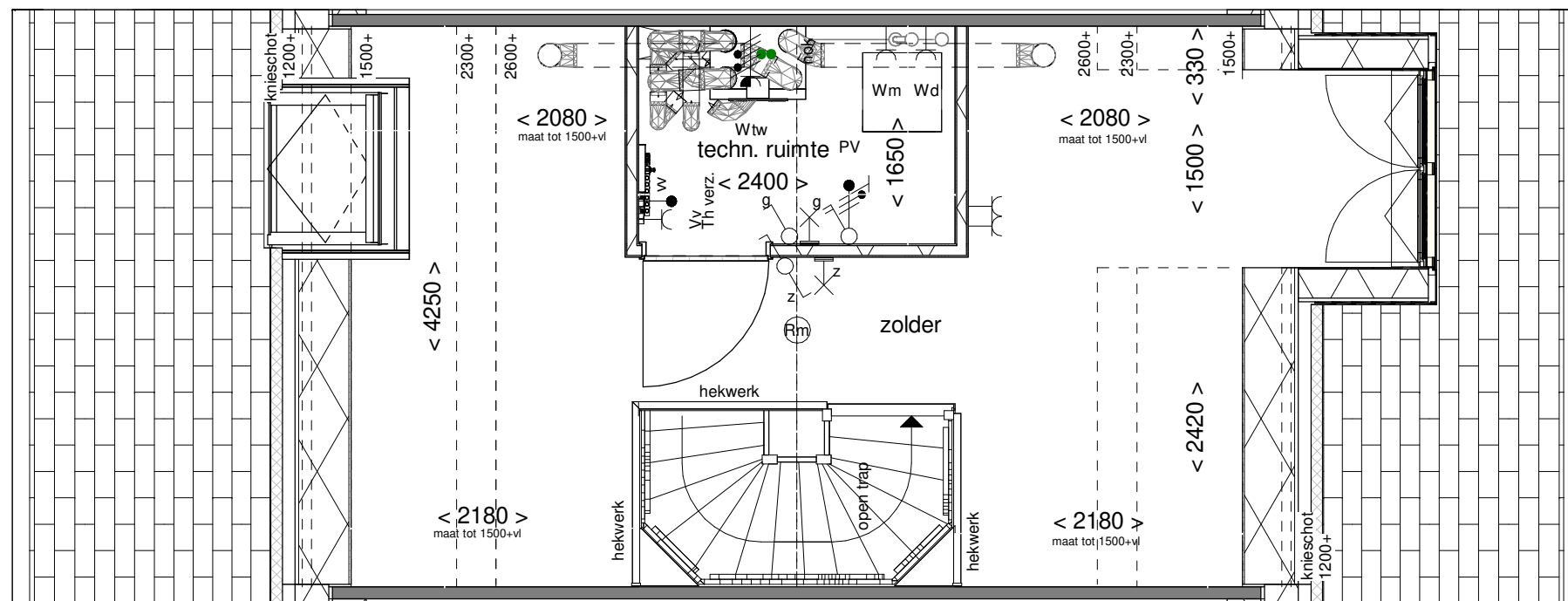

Voorgevel schaal 1:100

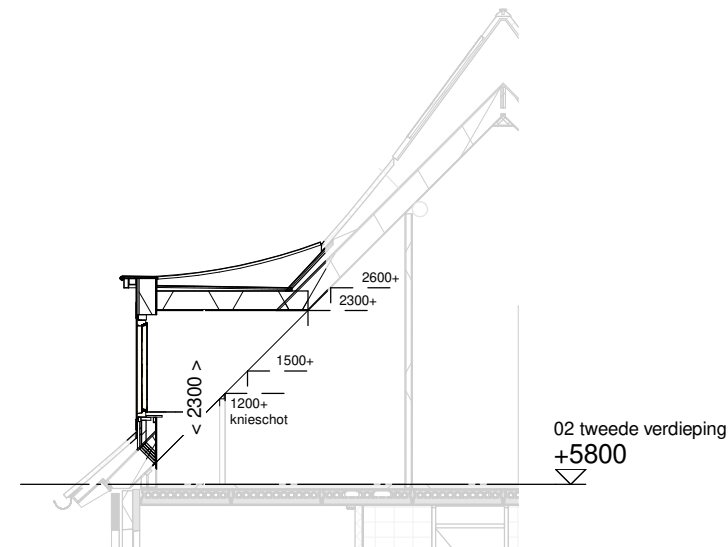

Doorsnede schaal 1:100

**ALLEMAAL
YIELEYAAL**

Optie: Dakkapel
voorgevel 1500mm

Woningtype: Y45

Bouwnummer: -

Optienummer: 1.B.X.33

Schaal: 1:50 / 1:100

Datum: 29-09-2021

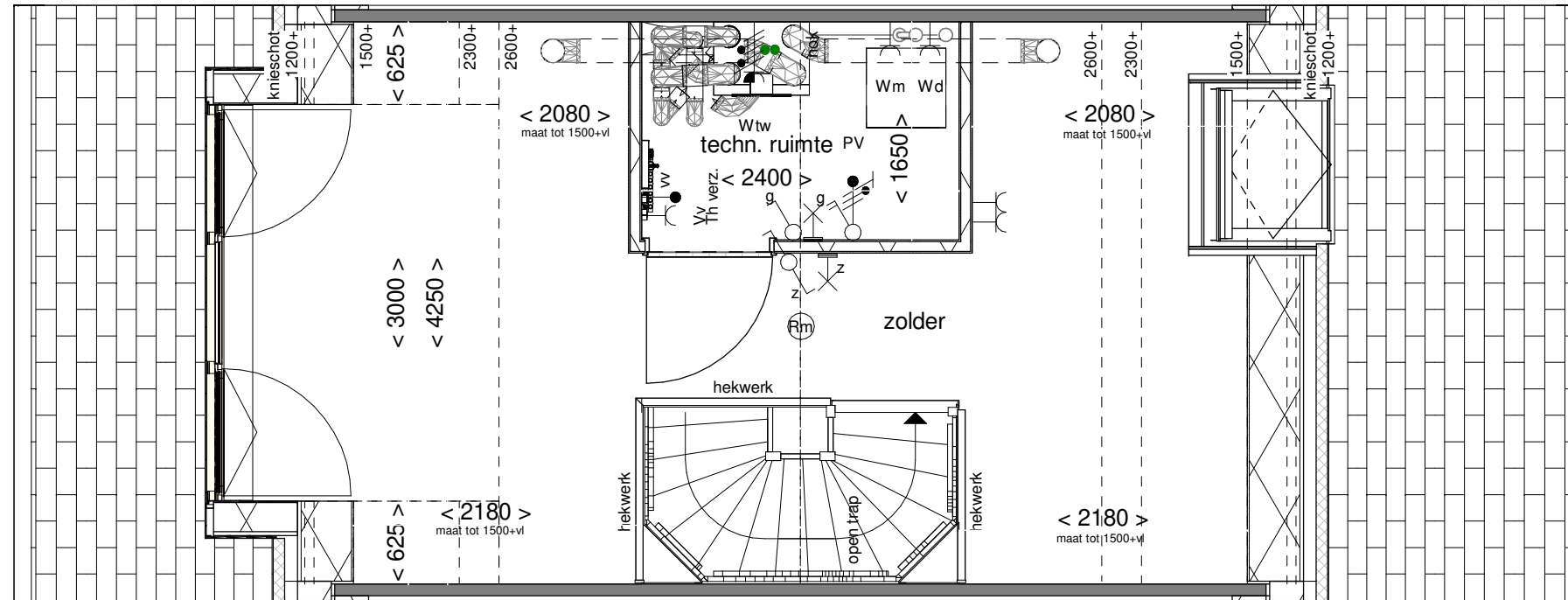

Achtergevel schaal 1:100

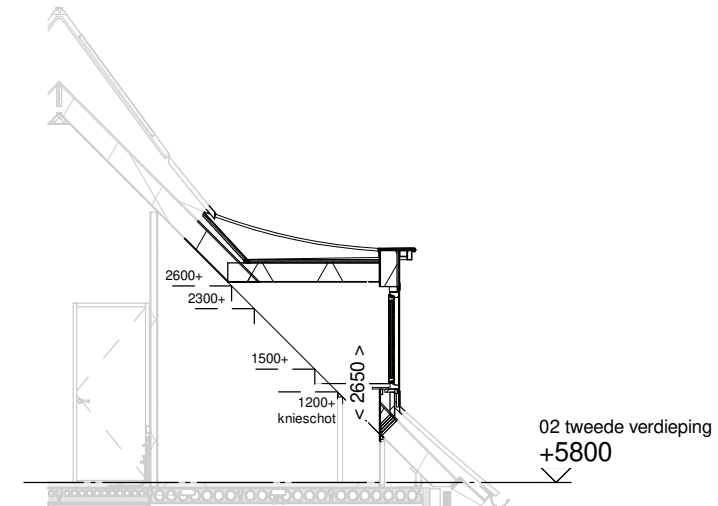

Achtergevel schaal 1:100

**ALLEMAAL
YIELEYAAL**

Optie: Dakkapel
achtergevel 3000mm

Woningtype: Y45

Bouwnummer: -

Optienummer: 1.B.X.34

Schaal: 1:50 / 1:100

Datum: 29-09-2021

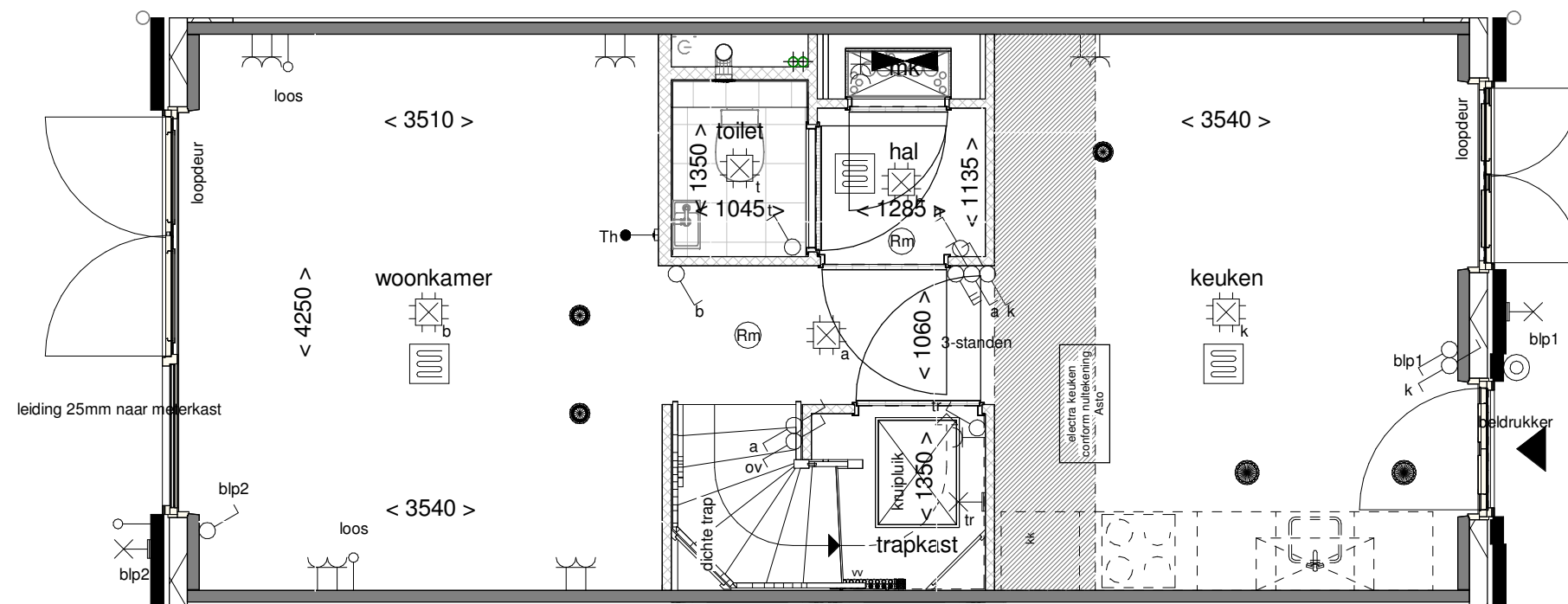

**ALLEMAAL
YIELEYAAL**

Optie: Wand naast trap

Woningtype: Y45

Bouwnummer: -

Optienummer: 1.C.Y.10

Schaal: 1:50

Datum: 29-09-2021

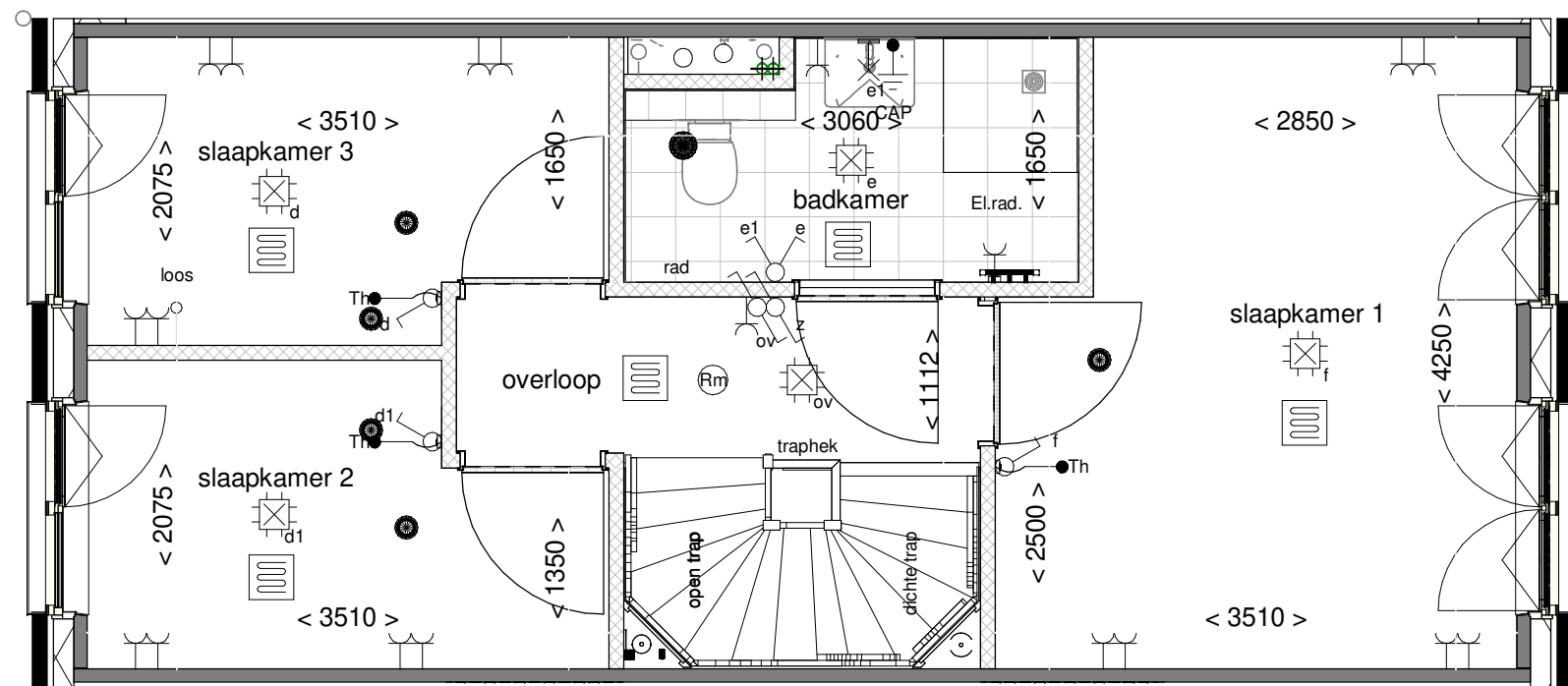

**ALLEMAAL
YIELEYAAL**

Optie: Twee slaapkamers
achterzijde

Woningtype: Y45

Bouwnummer: -

Optienummer: 1.C.Y.36

Schaal: 1:50

Datum: 29-09-2021

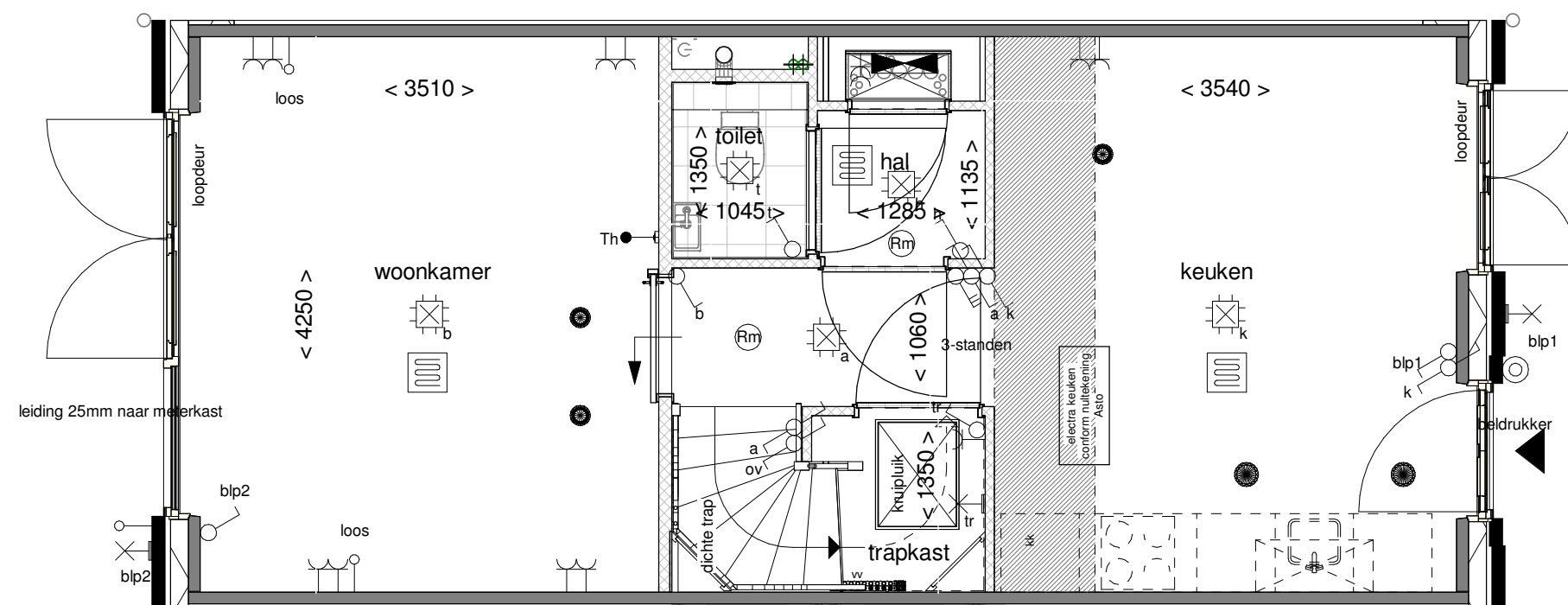

**ALLEMAAL
YIELEYAAL**

Optie: Schuifdeur tussen woonk. en keuken

Woningtype: Y45

Bouwnummer: -

Optienummer: 1.C.Y.42

Schaal: 1:50

Datum: 29-09-2021

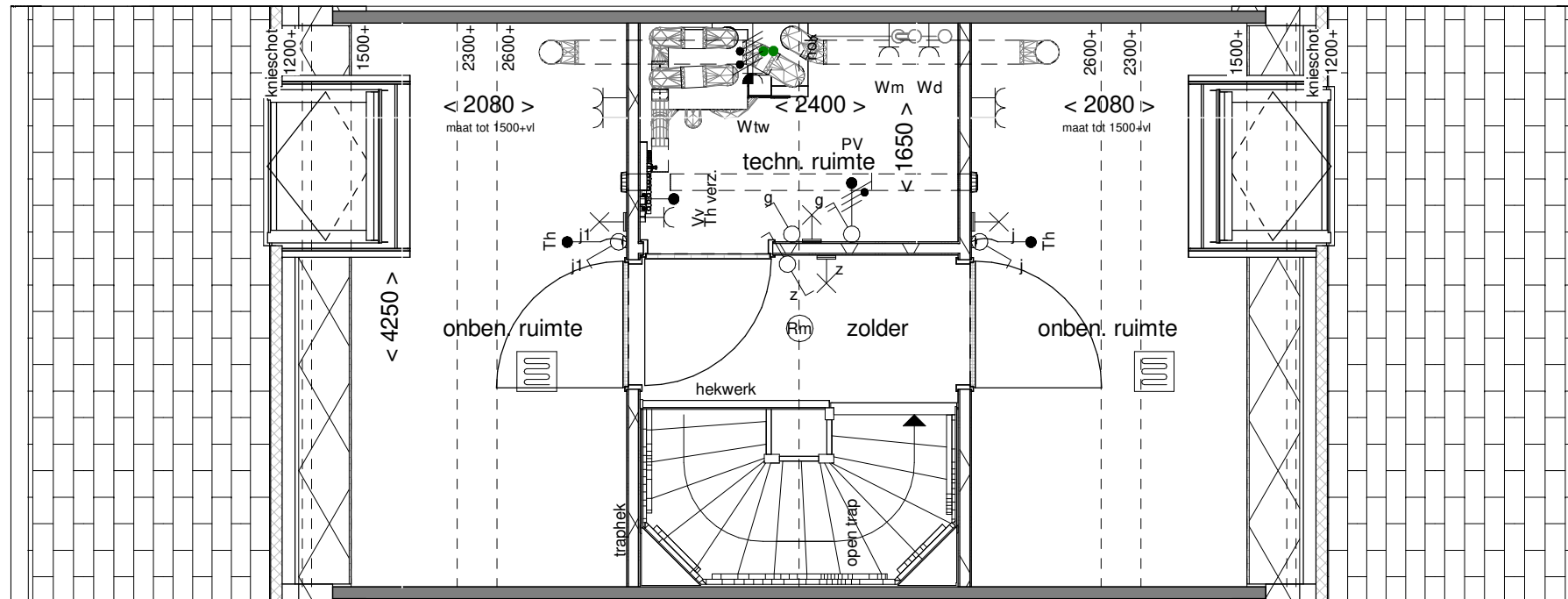

**ALLEMAAL
YIELEYAAL**

Optie: Indeling techn.- en
2 onb. ruimtes

Woningtype: Y45

Bouwnummer: -

Optienummer: 1.C.Y.76

Schaal: 1:50

Datum: 29-09-2021