

**ALLEMAAL  
YIELEYAAL**

Tekening: **Situatie totaal**

Woningtype:

Bouwnummer:

Bladnummer: **VT-S-01**

Schaal: **1:1000**

Datum: **27-10-2021**

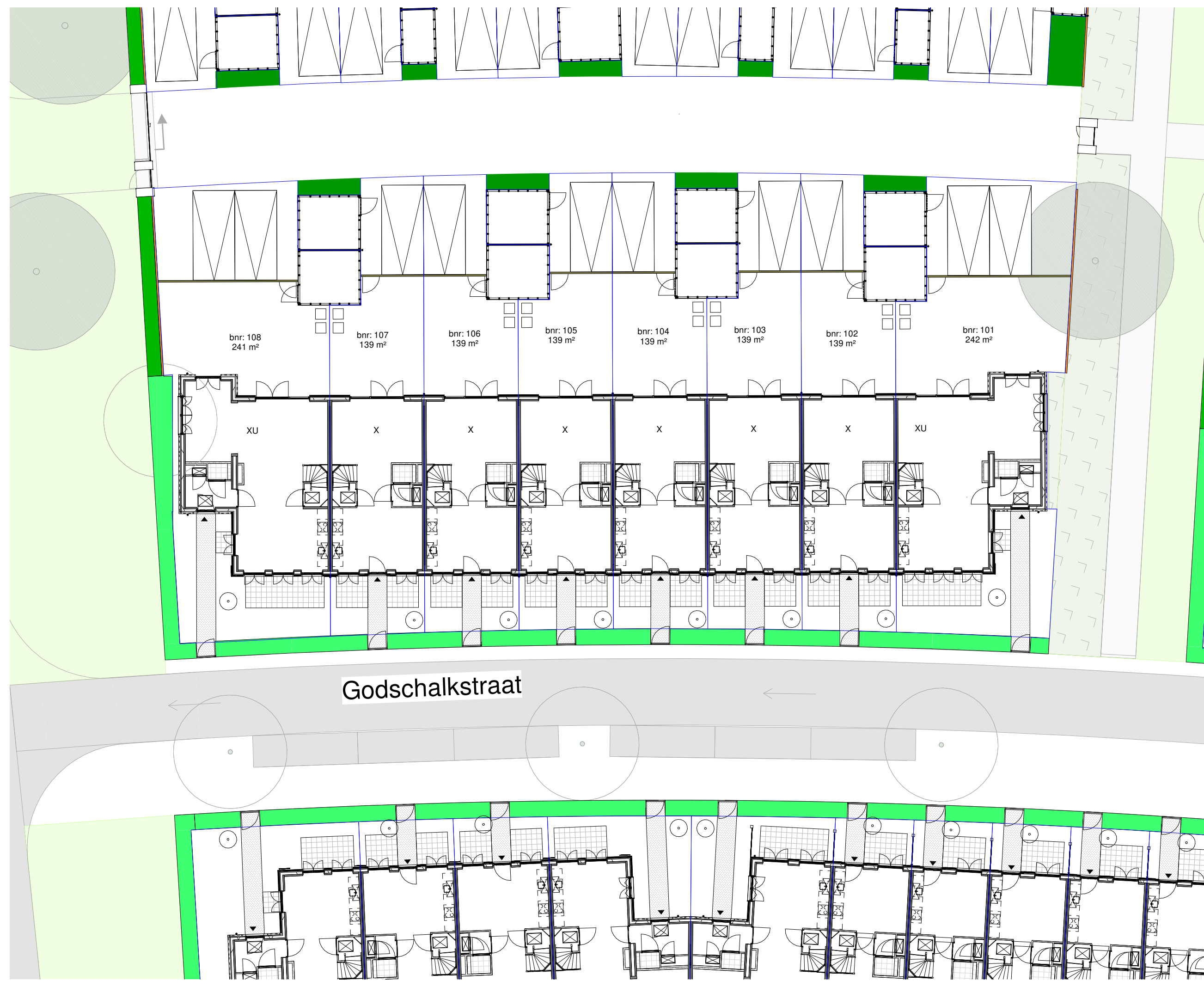

**Renvooi**

-  - entree woning
-  - parkeervak eigen terrein
-  - erfgrans
-  - beplanting  
type n.t.b. koper
-  - opstelplaats klike
-  - tuinhekje
-  - klinkerbestrating
-  - betontegels  
300x300mm
-  - groen strook
-  - haag h=900mm
-  - haag h=1800mm
-  - bamboehok h=1800mm
-  - gaashek met klimplanten  
en poort h=1600mm

**parkeerplekken en posities  
bomen en struiken zijn indicatief**

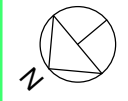











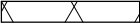

Godschalkstraat



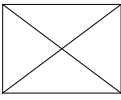

























**ALLEMAAL  
YIELEYAAL**

Tekening:	Situatie Blok F1
Woningtype:	XU,X
Bouwnummer:	101-108
Bladnummer:	VT-S-13
Schaal:	1:200
Datum:	27-10-2021

## Renvooi bouwkundig

	metselwerk kleur A
	dakpannen kleur oranje
	entree woning
	metselwerk
	isolatie
	dragende wand
	niet dragende binnenwand
	binnendeurkozijn (met bovenlicht)
	kruipluik
	opstelplaats wasmachine
	opstelplaats wasdroger
	
	principe opstelling keukenblok

## Renvooi installaties

	aansluitpunt licht
	aansluitpunt licht, wand
	centraaldoos met lichtpunt
	armatuur aan de wand
	rookmelder
	aansluitpunt niet bedraad
	verdeelinrichting / meterkast / groepenkast
	beldrukker
	schel
	schakelaar, 1-polig
	werkschakelaar tbv PV-panelen
	schakelaar, 3-polig
	schakelaar, wissel
	schakelaar, kruis
	schakelaar, serie
	wandcontactdoos 1-voudig met beschermingscontact
	wandcontactdoos 2-voudig met beschermingscontact, verticaal
	wandcontactdoos 2-voudig met beschermingscontact
	thermostaatleiding, bedraad
	mechanische ventilatie-unit incl. warmteterugwinunit
	warmtepomp
	inblaasventiel mechanische ventilatie
	uitblaasventiel mechanische ventilatie
	verdeler vloerverwarming
	ruimte voorzien van vloerverwarming
	elektrische radiator
	kanalen in het zicht
	onbenoemde ruimte volgens krijstreepmethode

### Disclaimer

De op deze tekeningen aangegeven maten zijn circa maten in millimeters en tussen de wanden / vloeren gemeten, waarbij geen rekening is gehouden met enige wandafwerking, plinten, aftimmering, ect. In verband met de nauwkeurige uitwerking van details, constructie, maatvoering, materialen e.d. kunnen er kleine afwijkingen ontstaan ten opzichte van de nu vermelde gegevens. Deze geringe afwijkingen geven geen aanleiding tot verrekening. Aan de op deze tekening aangegeven maten kunnen derhalve geen rechten worden ontleend. De op deze tekeningen aangegeven maatvoering is niet geschikt voor opdrachten aan derden door koper(s). De posities van aansluitingen en installatie onderdelen zijn indicatief op tekening aangegeven. De exacte aantallen en posities zullen na berekening in het werk door de installateurs worden bepaald en kunnen afwijken van deze tekening.

**ALLEMAAL  
YIELEYAAL**

Tekening: Renvooi

Woningtype: -

Bouwnummer: -

Bladnummer: VT-0-00c

Schaal: -

Datum: 27-10-2021



Type: XU  
bwnr: 108

Type: X  
bwnr: 107

Type: X  
bwnr: 106

Type: X  
bwnr: 105

Type: X  
bwnr: 104

Type: X  
bwnr: 103

Type: X  
bwnr: 102

Type: XU  
bwnr: 101



Type: XU  
bwnr: 101

Type: X  
bwnr: 102

Type: X  
bwnr: 103

Type: X  
bwnr: 104

Type: X  
bwnr: 105

Type: X  
bwnr: 106

Type: X  
bwnr: 107

Type: XU  
bwnr: 108

**ALLEMAAL  
YIELEYAAL**

Tekening: Gevels blok F1

Woningtype: X-U, X

Bouwnummer: 101 t/m 108

Bladnummer: VT-F1-00a

Schaal: 1:150

Datum: 27-10-2021

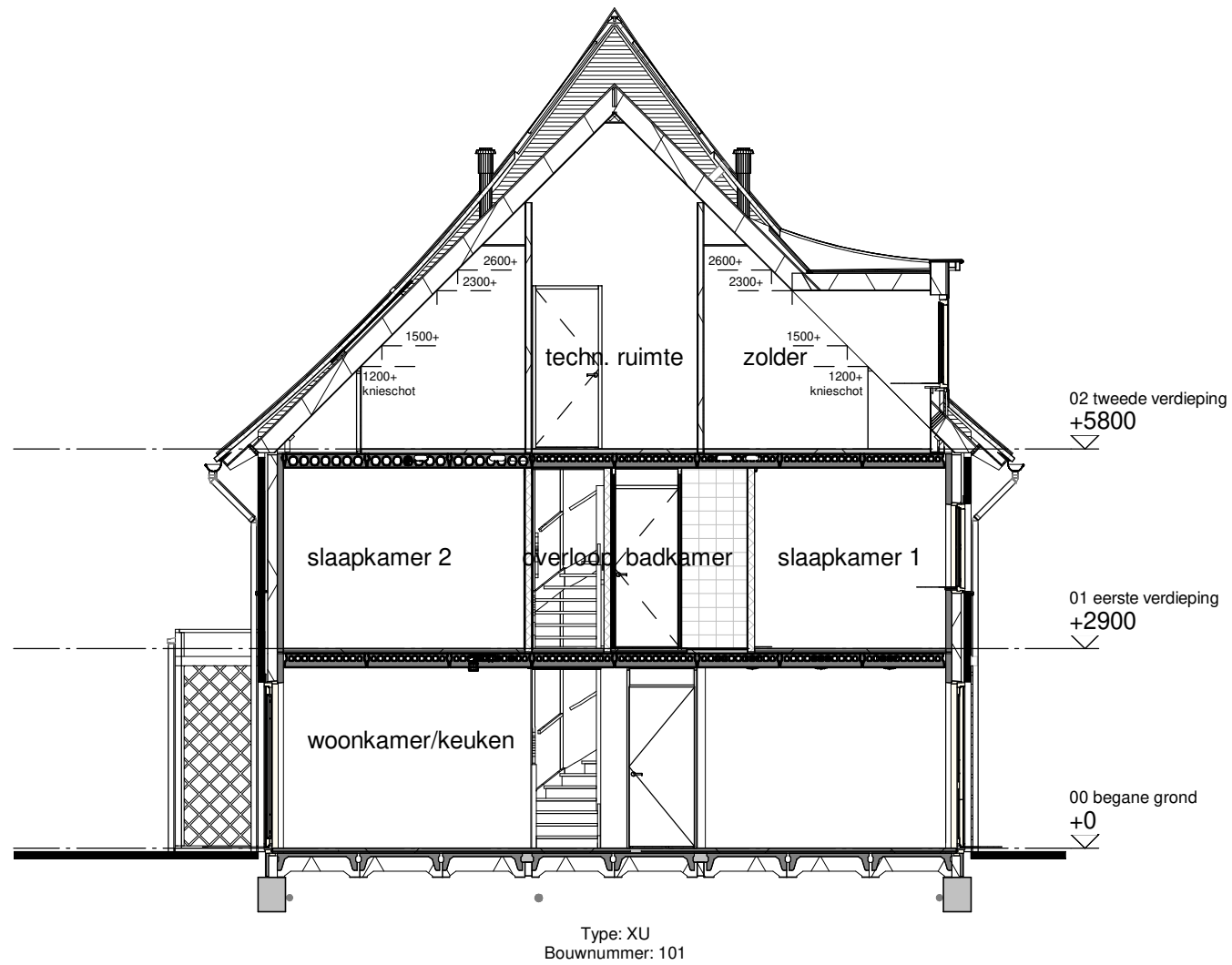

Doorsnede A

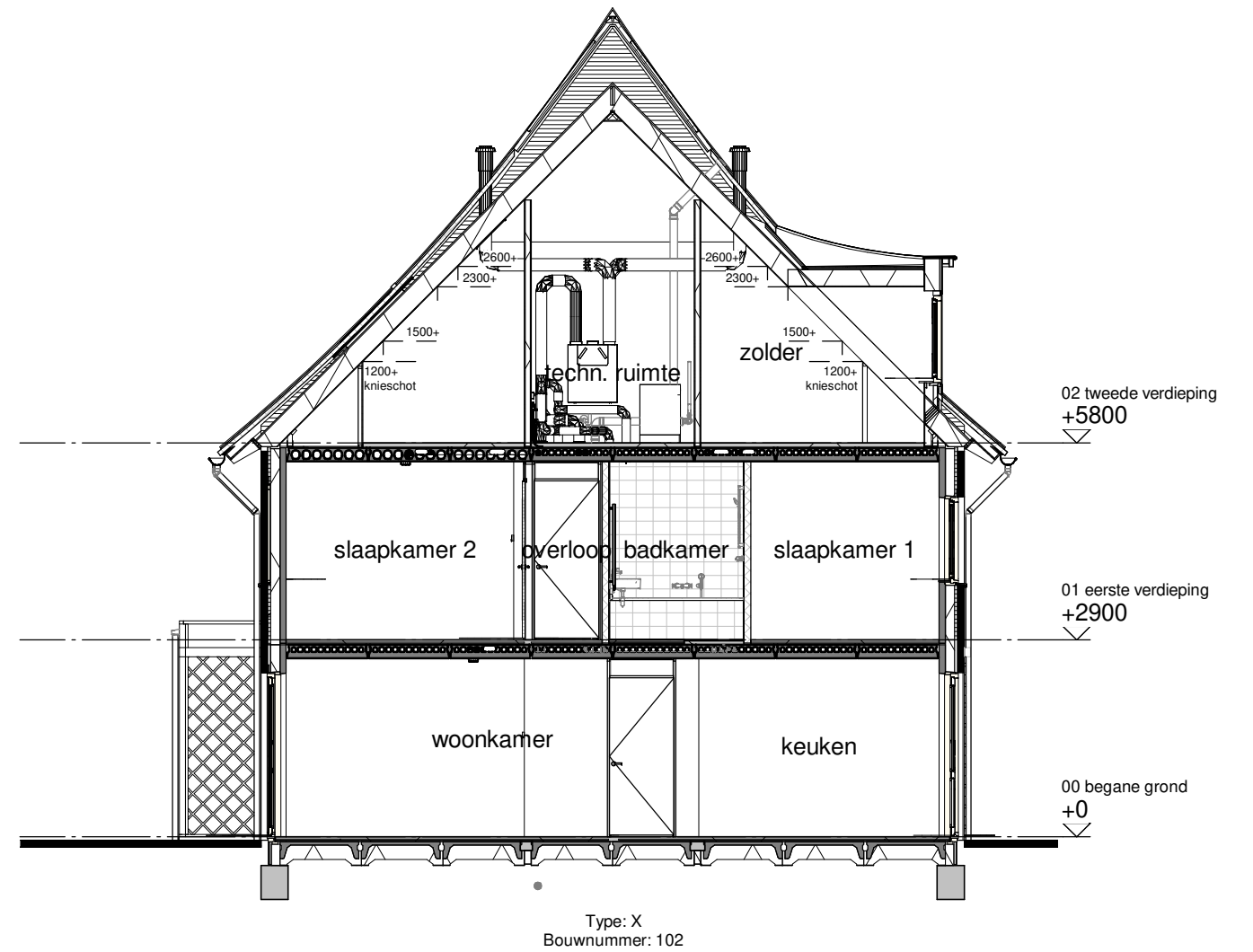

Doorsnede B

ALLEMAAL  
YIELEYAAL

Tekening: Doorsnedes blok F1

Woningtype: XU, X

Bouwnummer: 101-108

Bladnummer: VT-F1-00c

Schaal: 1:100

Datum: 27-10-2021



Type: X-U  
Bouwnummer: 108

Linker zijgevel



Type: X-U  
Bouwnummer: 101

Rechter zijgevel

**ALLEMAAL  
YIELEYAAL**

Tekening: Zijgevels blok F1

Woningtype: X, X-U

Bouwnummer: 101 t/m 108

Bladnummer: VT-F1-00b

Schaal: 1:100

Datum: 27-10-2021

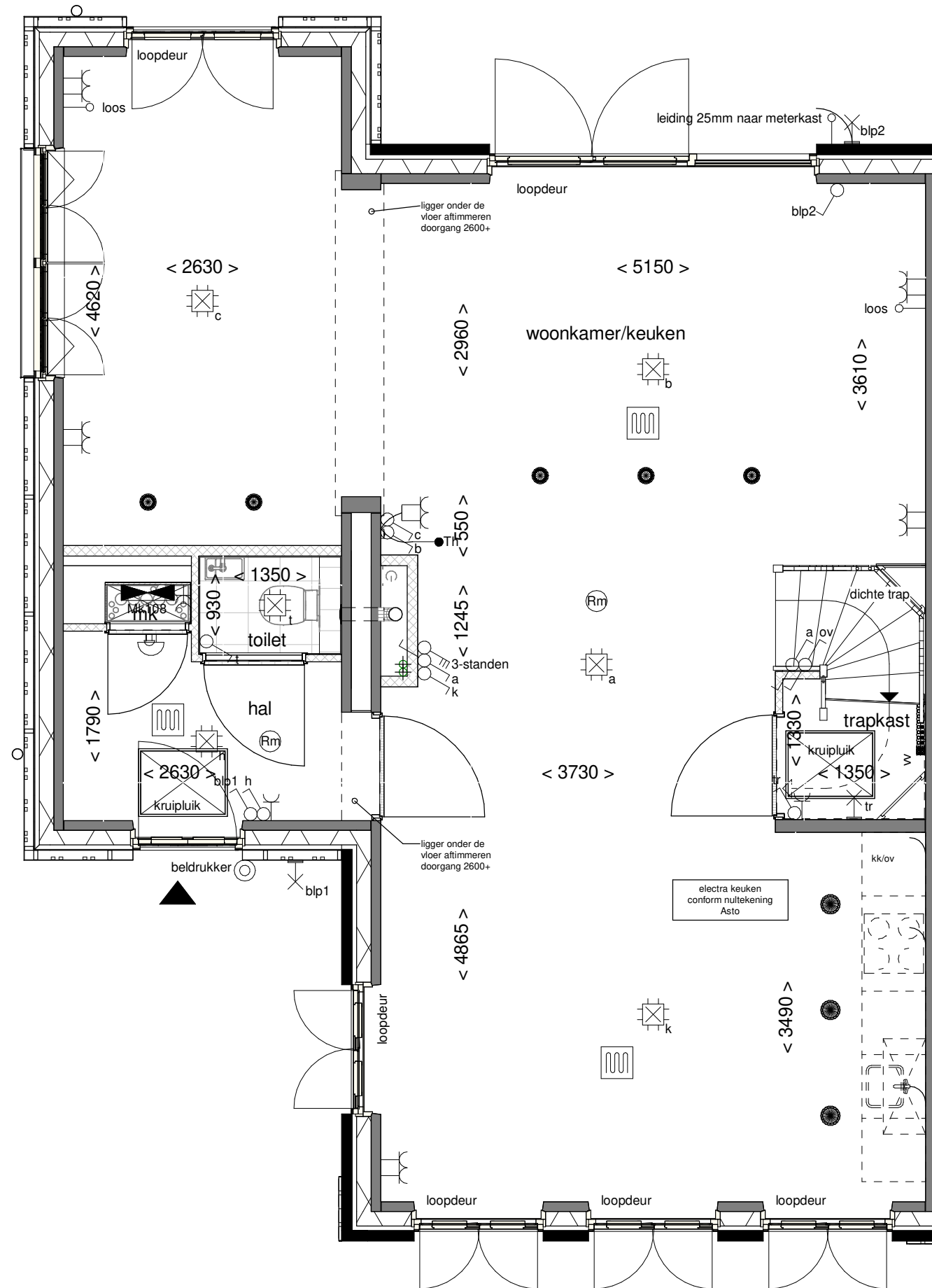

**ALLEMAAL  
YIELEYAAL**

Tekening: Begane grond

Woningtype: XU

Bouwnummer: 108

Bladnummer: VT-F1-108a

Schaal: 1:50

Datum: 27-10-2021

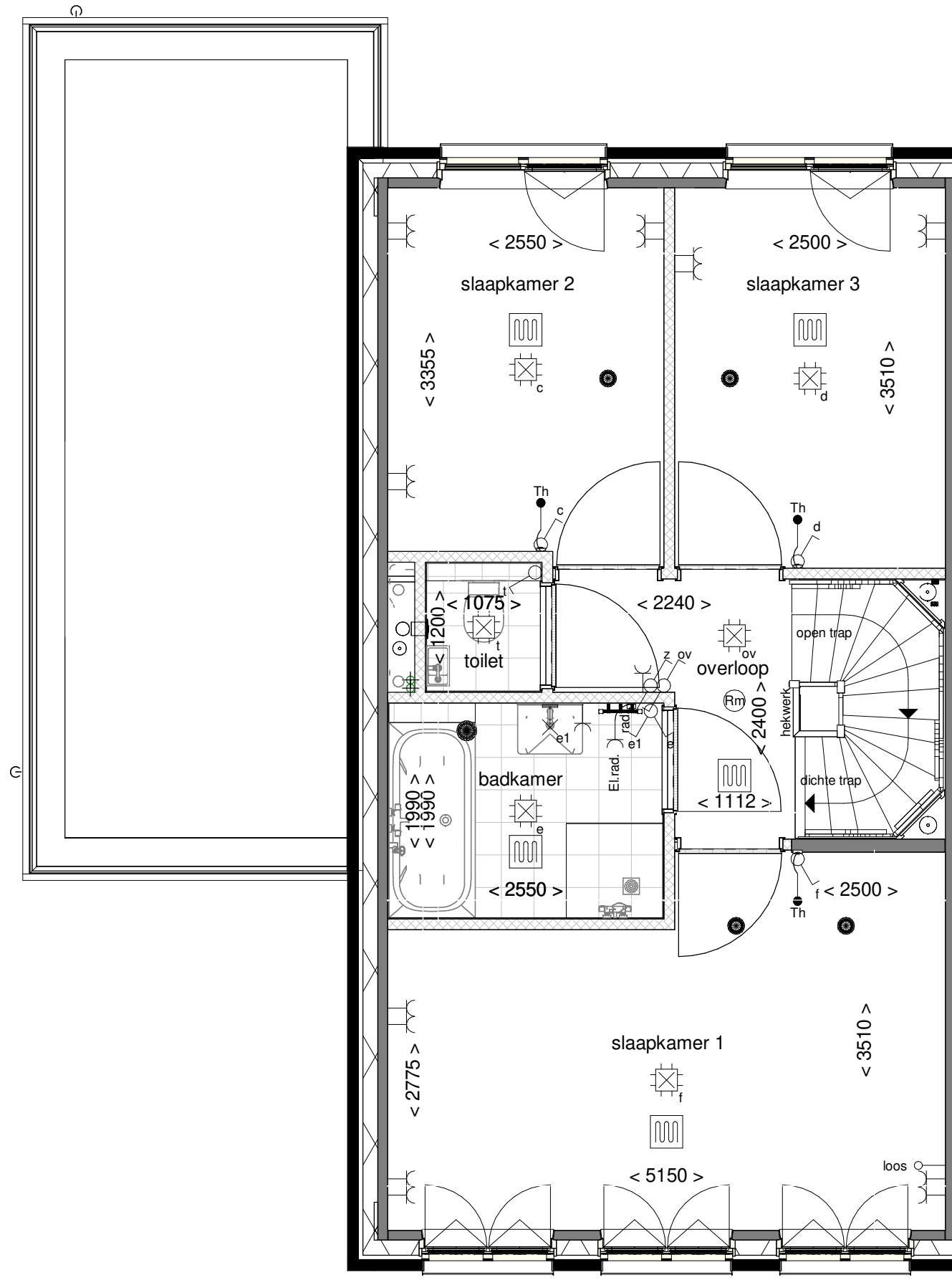

**ALLEMAAL  
VIELEJAAR**

Tekening: Eerste verdieping

Woningtype: XU

Bouwnummer: 108

Bladnummer: VT-F1-108b

Schaal: 1:50

Datum: 27-10-2021



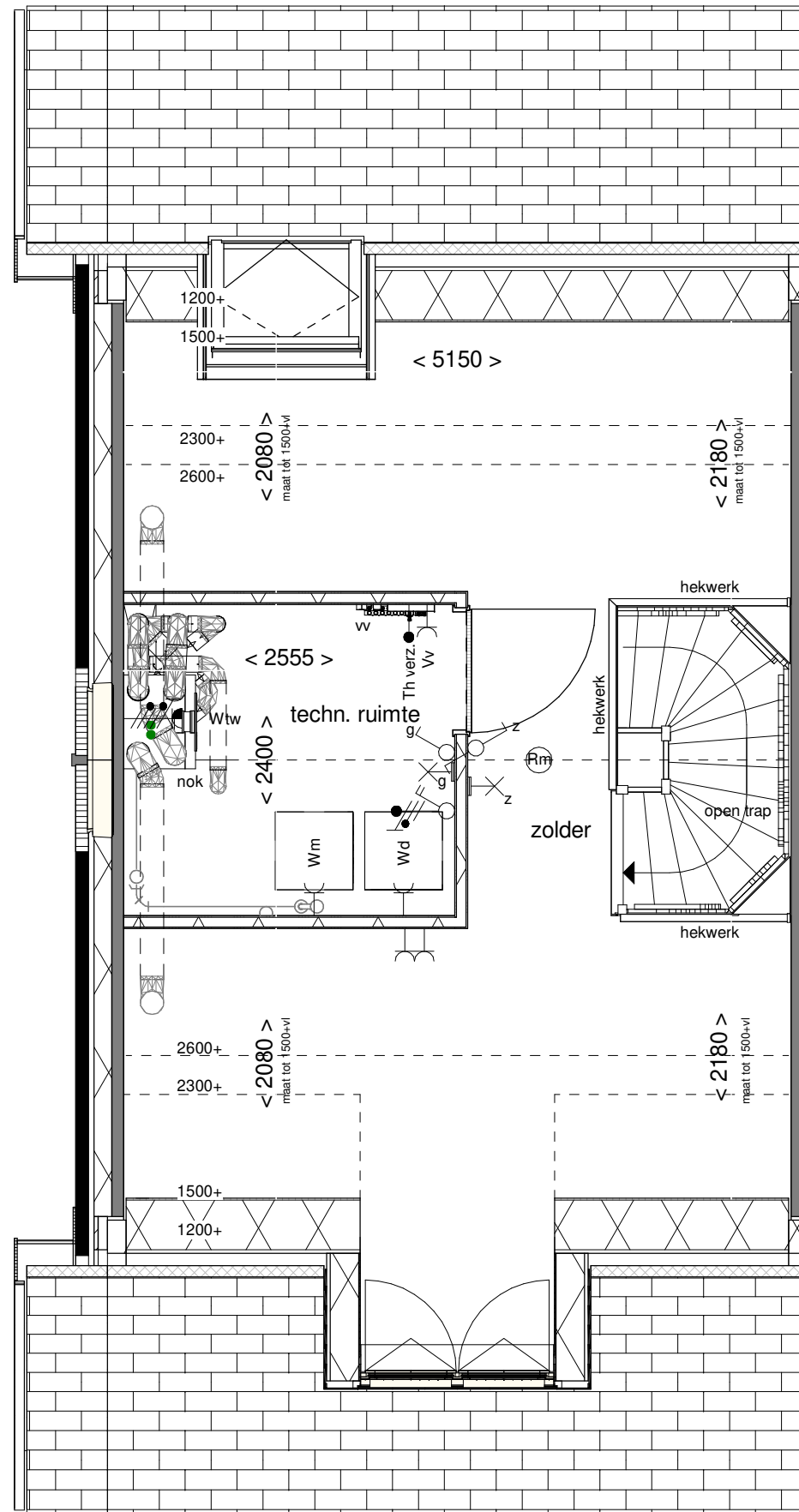

**ALLEMAAL  
YIELEYAAL**

Tekening: Tweede verdieping

Woningtype: XU

Bouwnummer: 108

Bladnummer: VT-F1-108c

Schaal: 1:50

Datum: 27-10-2021

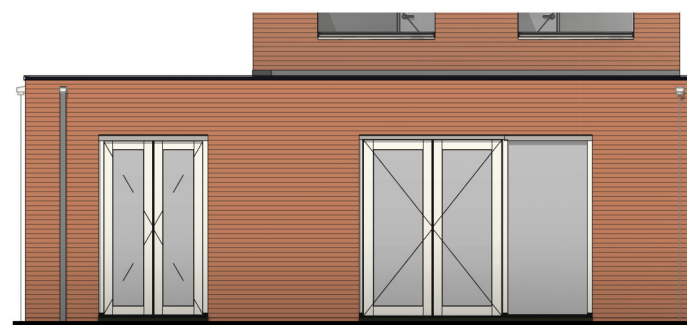
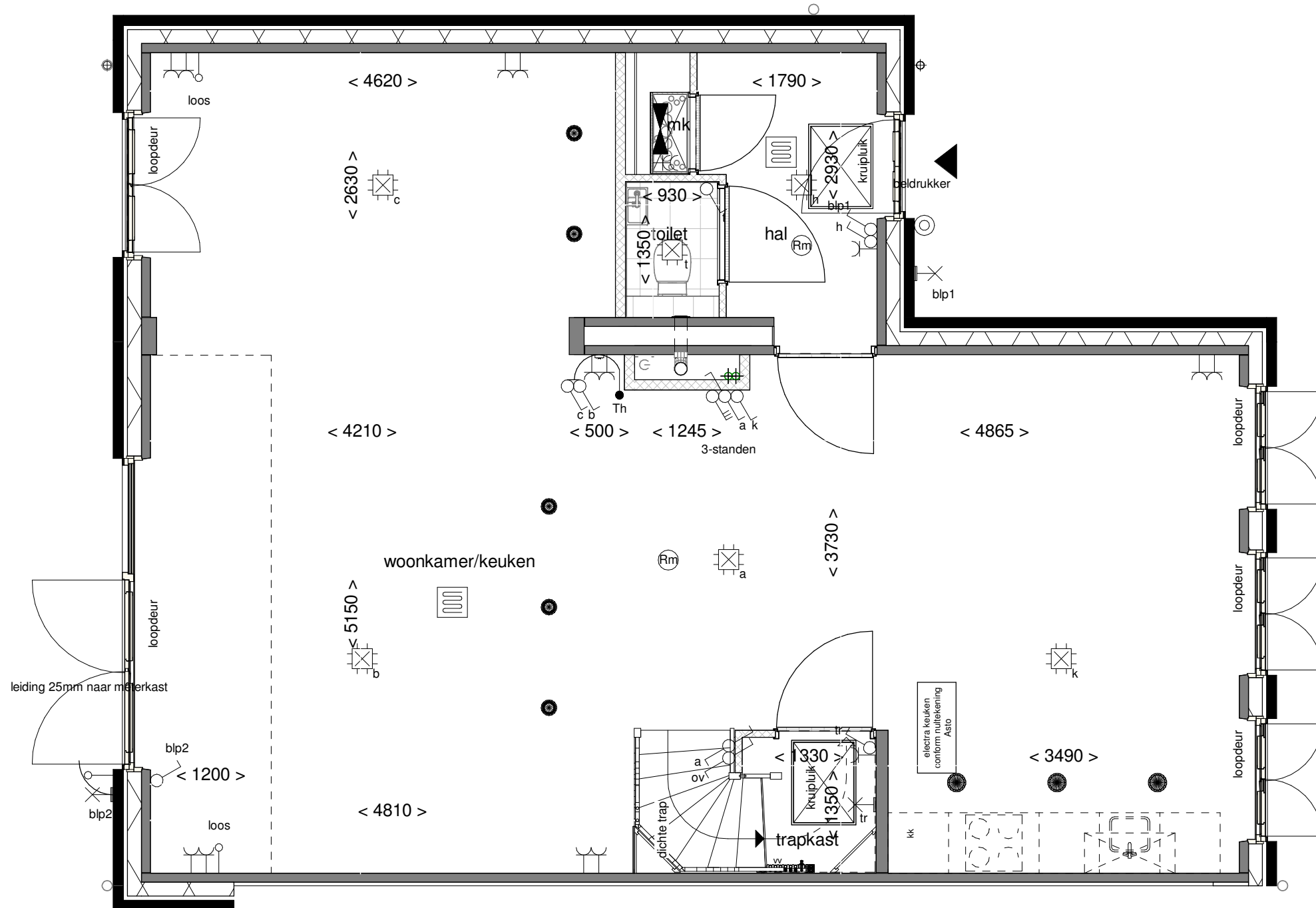

Achtergevel schaal 1:100

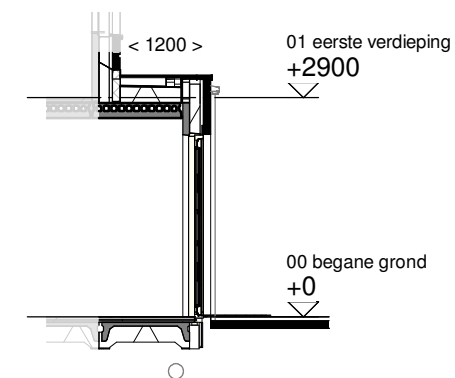

Doorsnede schaal 1:100

**ALLEMAAL  
YIELEYAAL**

Optie: **Uitbouw achtergevel  
1200mm**

Woningtype: **X54U**

Bouwnummer: -

Optienummer: **1.A.X.12**

Schaal: **1:50 / 1:100**

Datum: **29-09-2021**

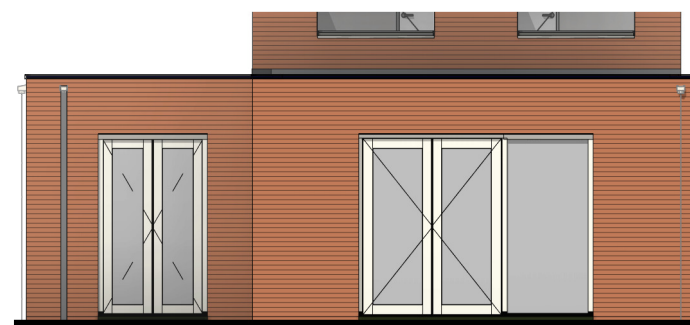
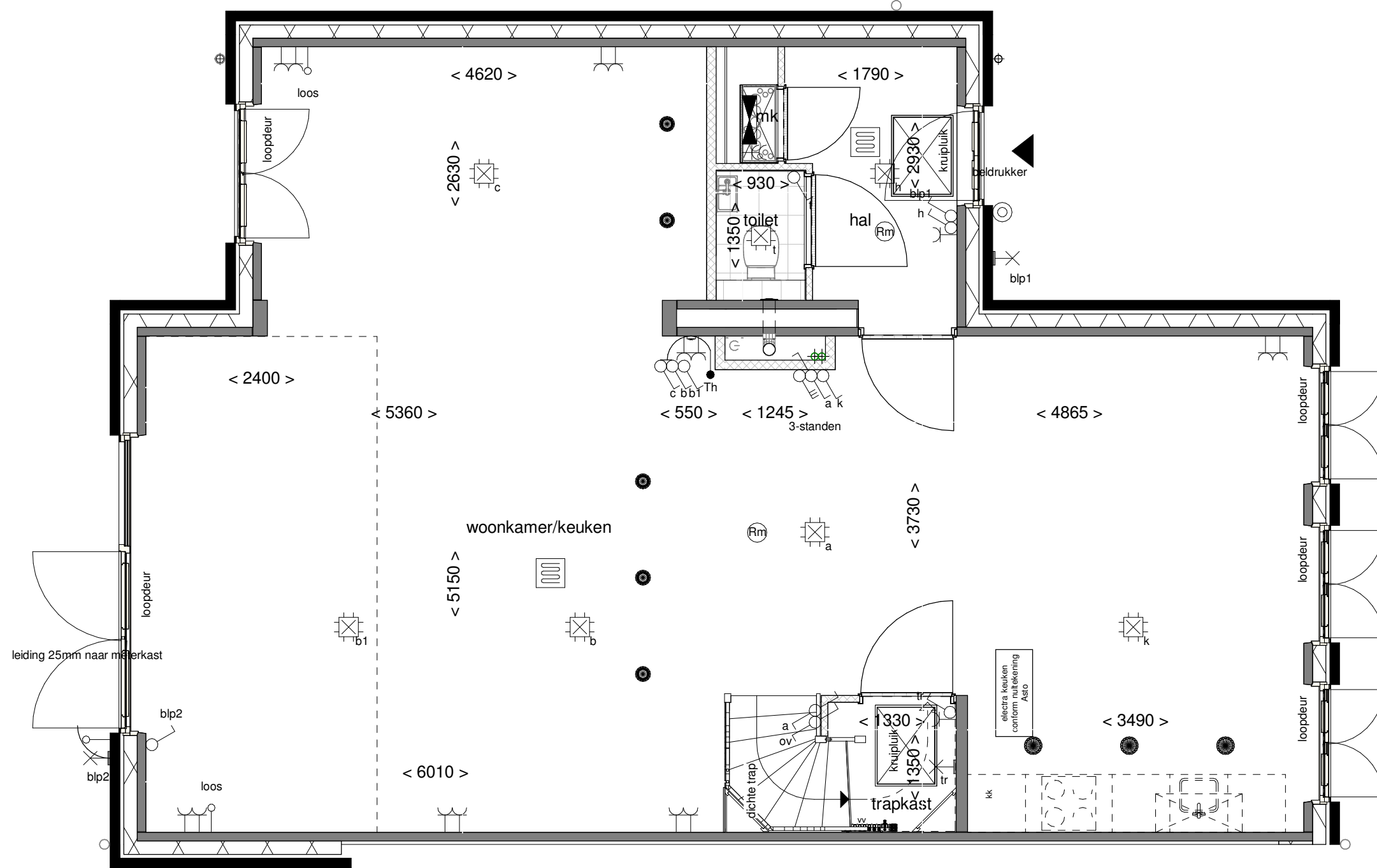

Achtergevel schaal 1:100

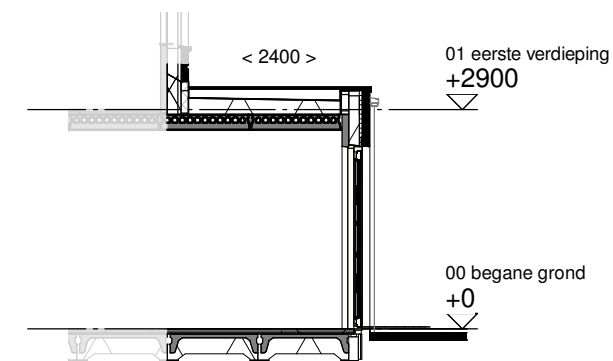

Doorsnede schaal 1:100

**ALLEMAAL  
VIELEJAAR**

Optie: **Uitbouw achtergevel  
2400mm**

Woningtype: **X54U**

Bouwnummer: -

Optienummer: **1.A.X.32**

Schaal: **1:50 / 1:100**

Datum: **29-09-2021**

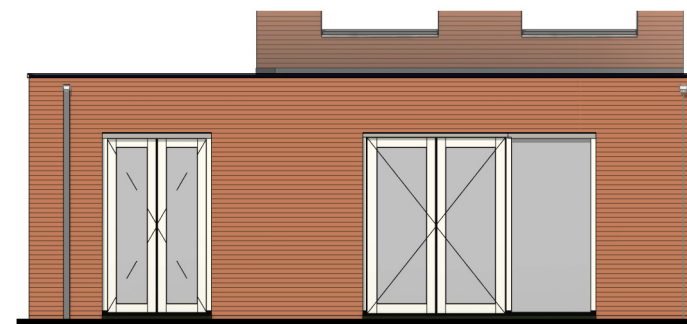
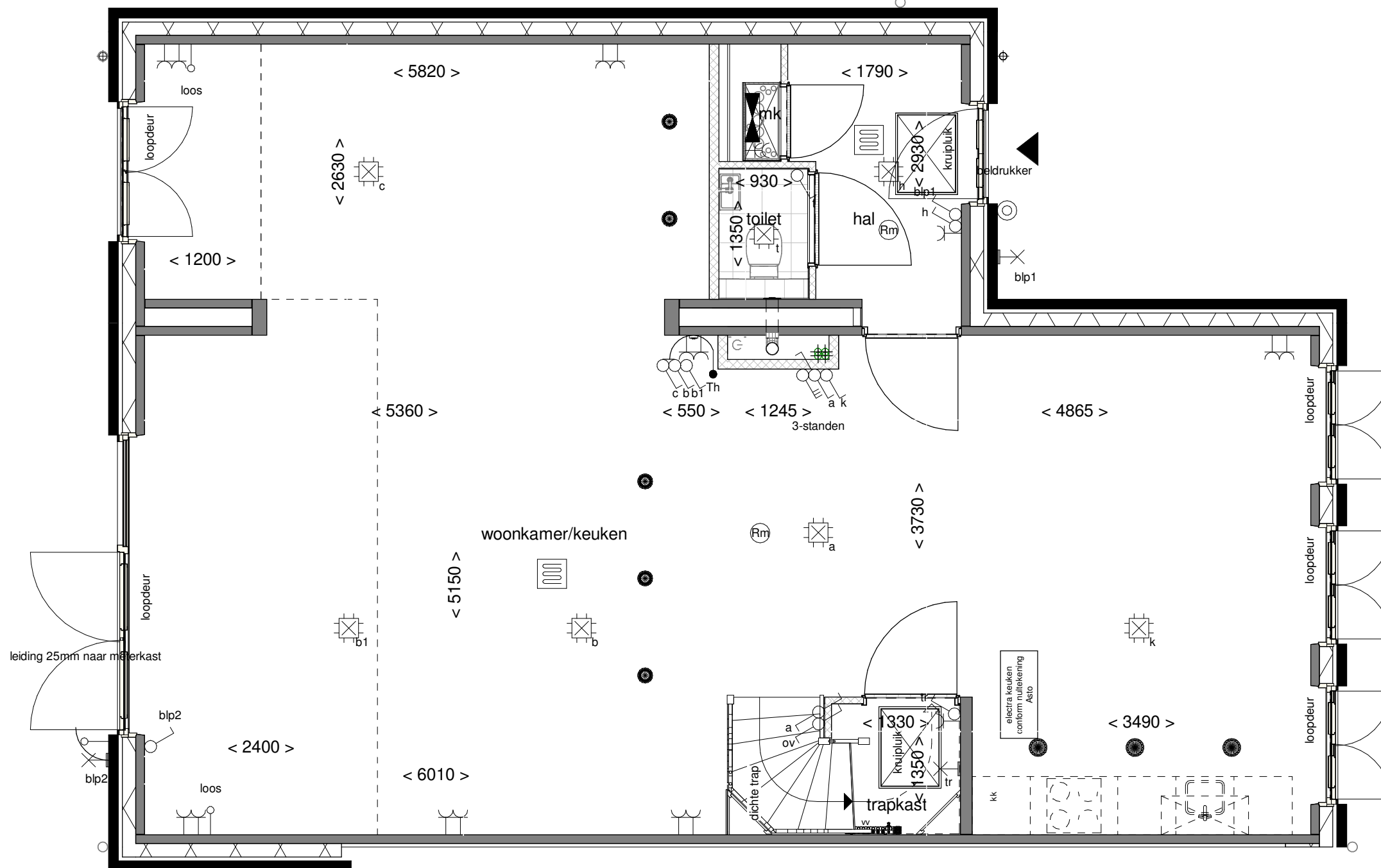

Achtergevel schaal 1:100

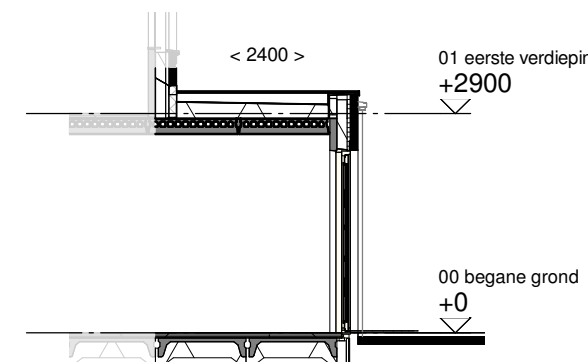

Doorsnede schaal 1:100

**ALLEMAAL  
YIELEYAAL**

Optie: Uitb. achter 2400mm  
+ zijuitbouw 1200mm

Woningtype: X54U

Bouwnummer: -

Optienummer: 1.A.X.52B

Schaal: 1:50 / 1:100

Datum: 29-09-2021

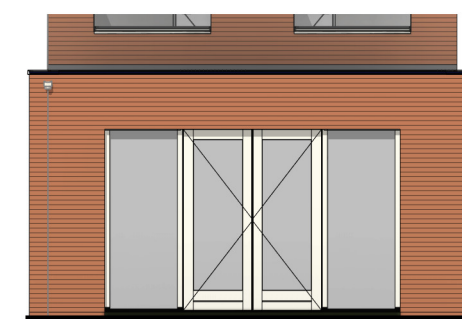
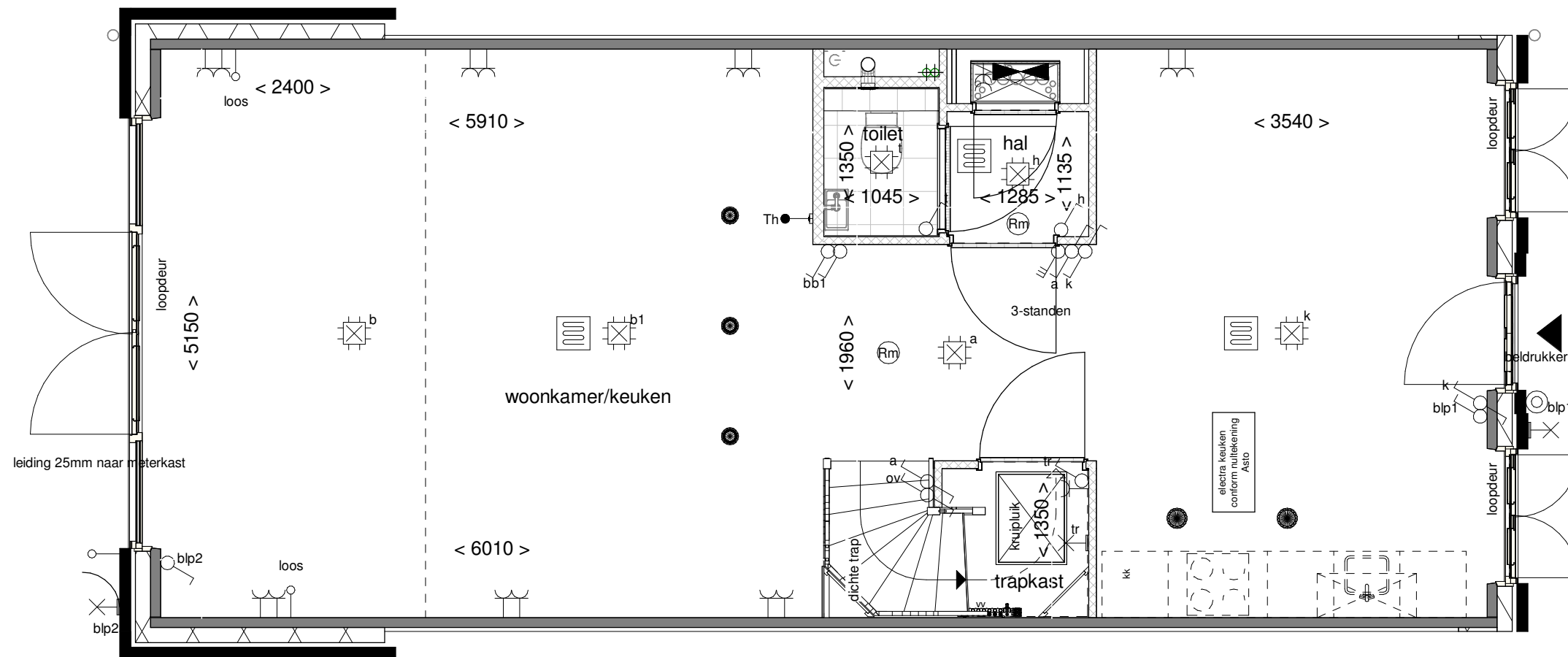

Achtergevel schaal 1:100

**ALLEMAAL  
VIELEJAAR**

Optie: Dubbele deuren  
achtergevel 3900mm

Woningtype: X54

Bouwnummer: -

Optienummer: 1.A.X.62

Schaal: 1:50 / 1:100

Datum: 29-09-2021

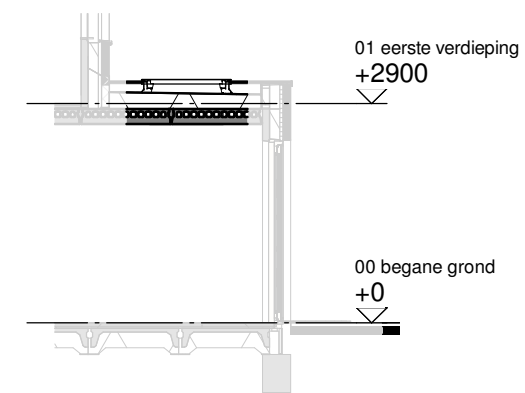
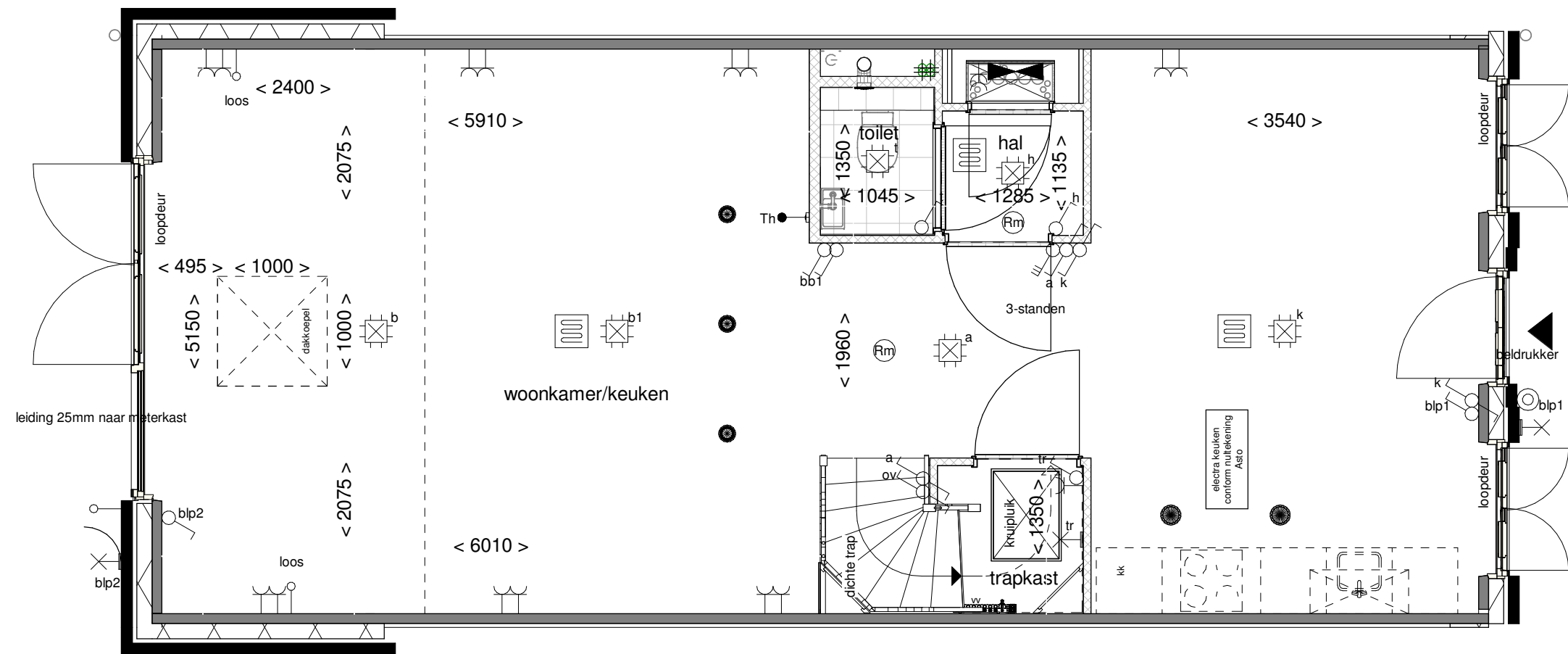

Doorsnede schaal 1:100

**ALLEMAAL  
YIELEYAAL**

Optie: Lichtkoepel in  
uitbouw 2400mm

Woningtype: X54

Bouwnummer: -

Optienummer: 1.B.X.10

Schaal: 1:50 / 1:100

Datum: 29-09-2021

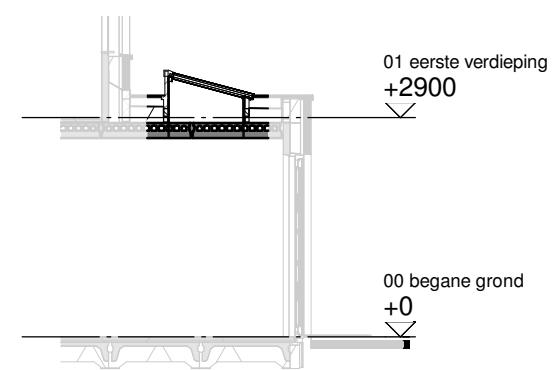
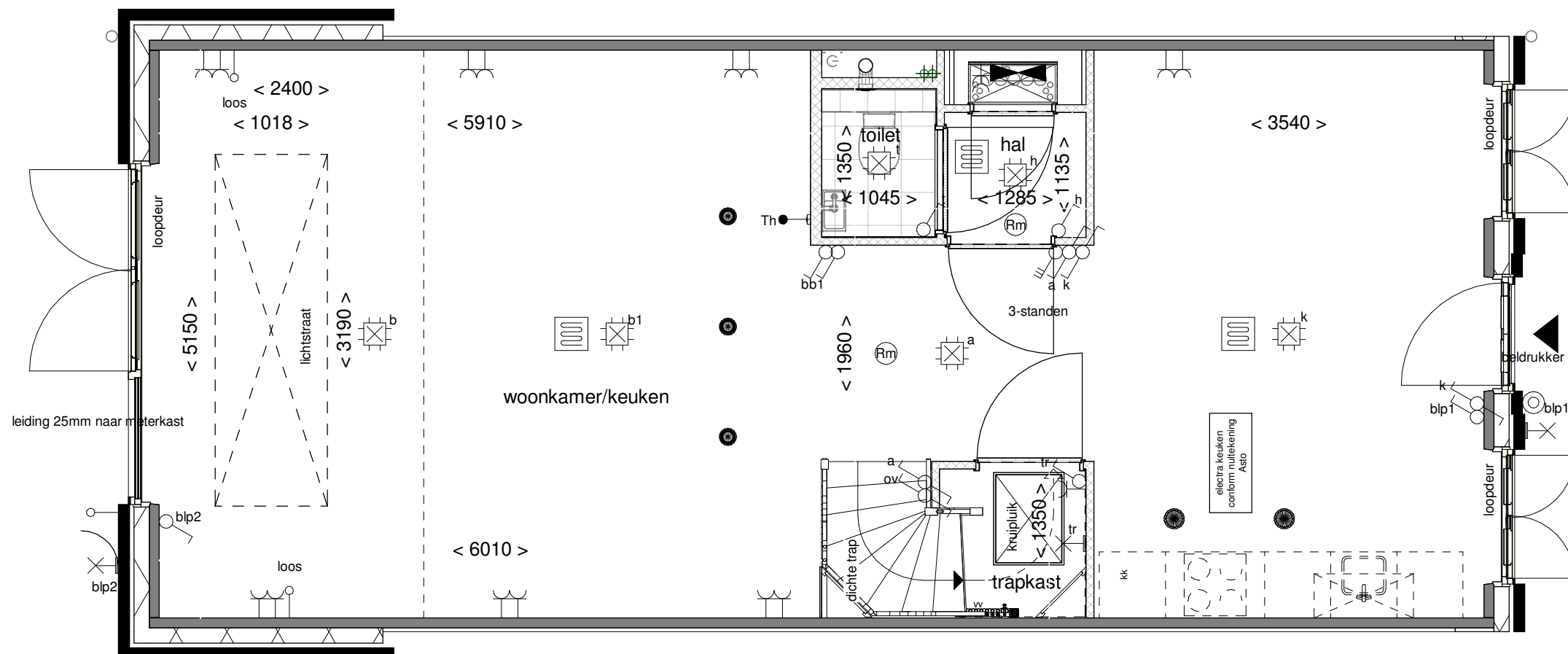

Doorsnede schaal 1:100

**ALLEMAAL  
YIELEYAAL**

Optie: Lichtstraat in uitbouw  
2400mm

Woningtype: X54

Bouwnummer: -

Optienummer: 1.B.X.14

Schaal: 1:50 / 1:100

Datum: 29-09-2021

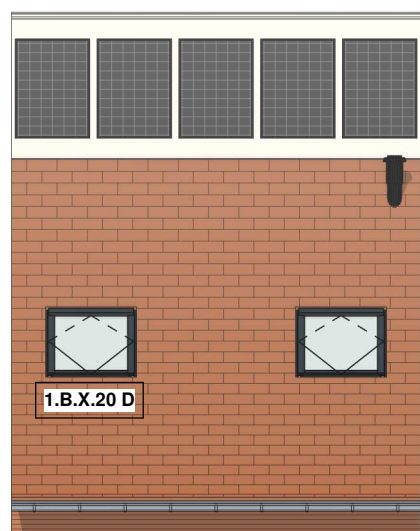
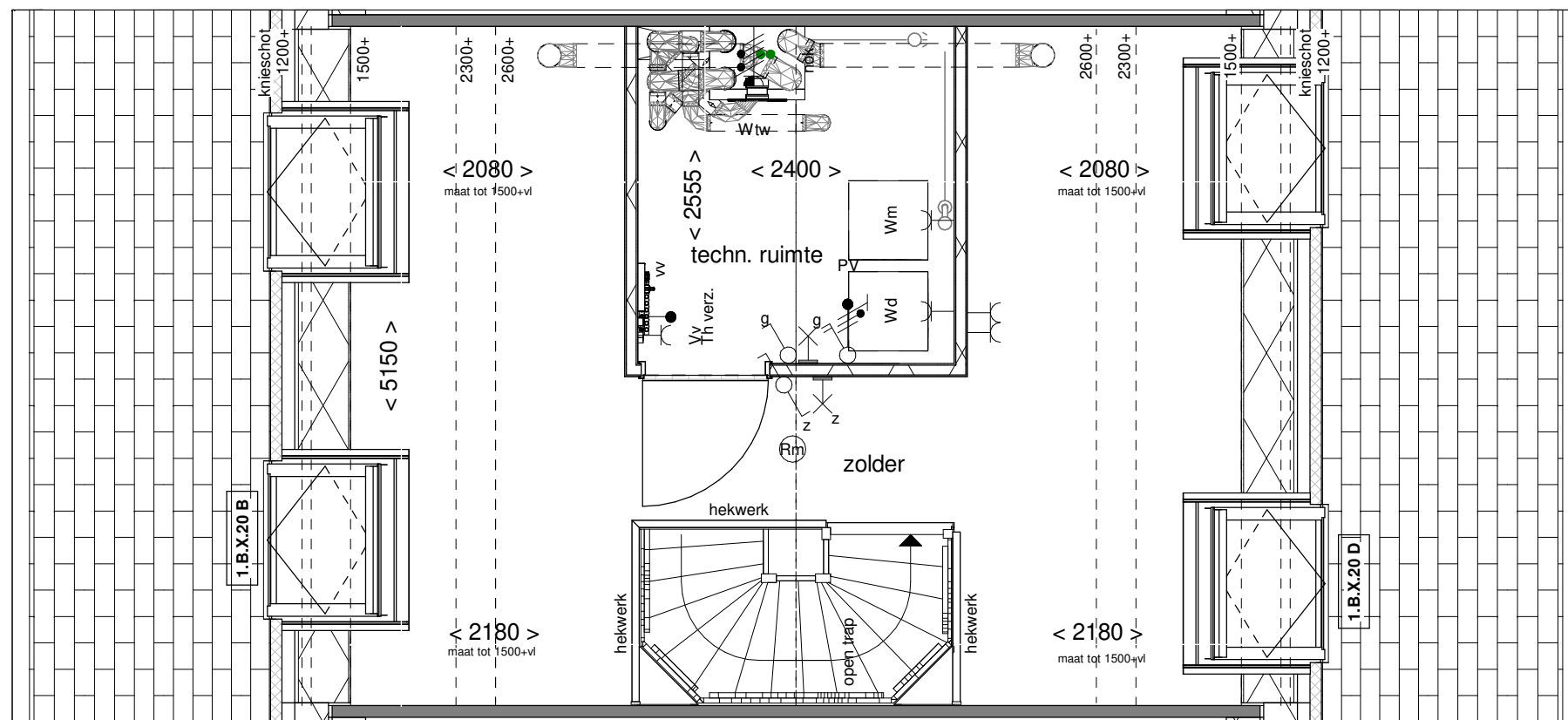

Voorgevel schaal 1:100

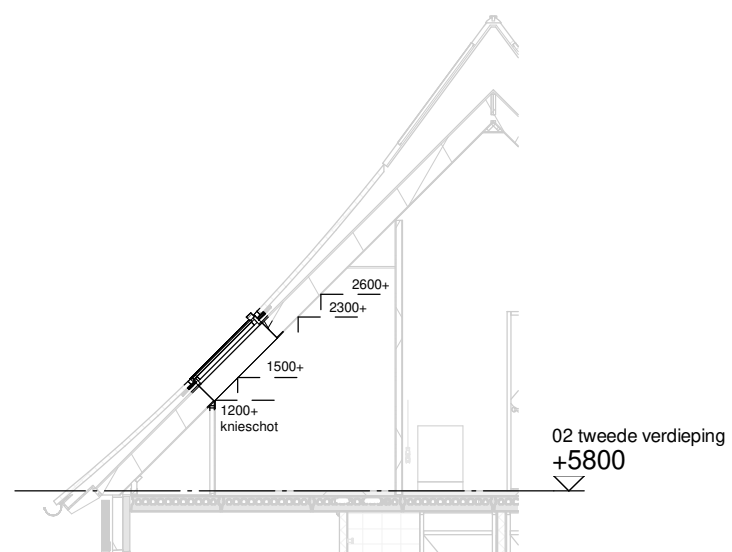

Doorsnede schaal 1:100

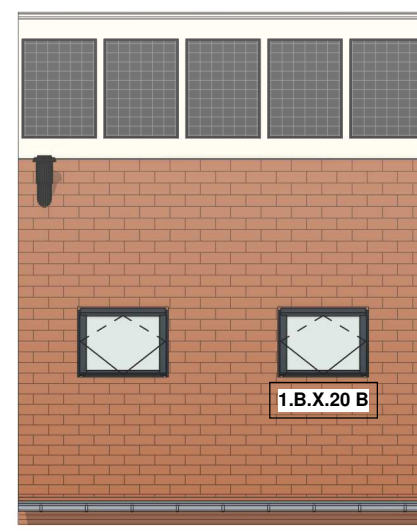

Achtergevel schaal 1:100

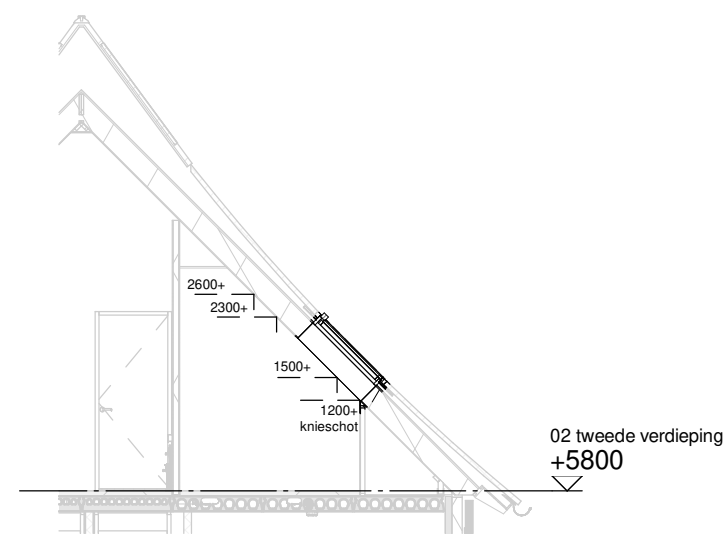

Doorsnede schaal 1:100

**ALLEMAAL  
VIELEJAAL**

Optie: Dakramen voor- en achtergevel

Woningtype: X54

Bouwnummer: -

Optienummer: 1.B.X.20

Schaal: 1:50 / 1:100

Datum: 29-09-2021



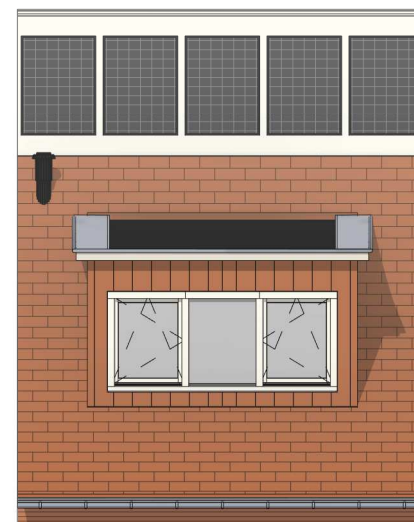
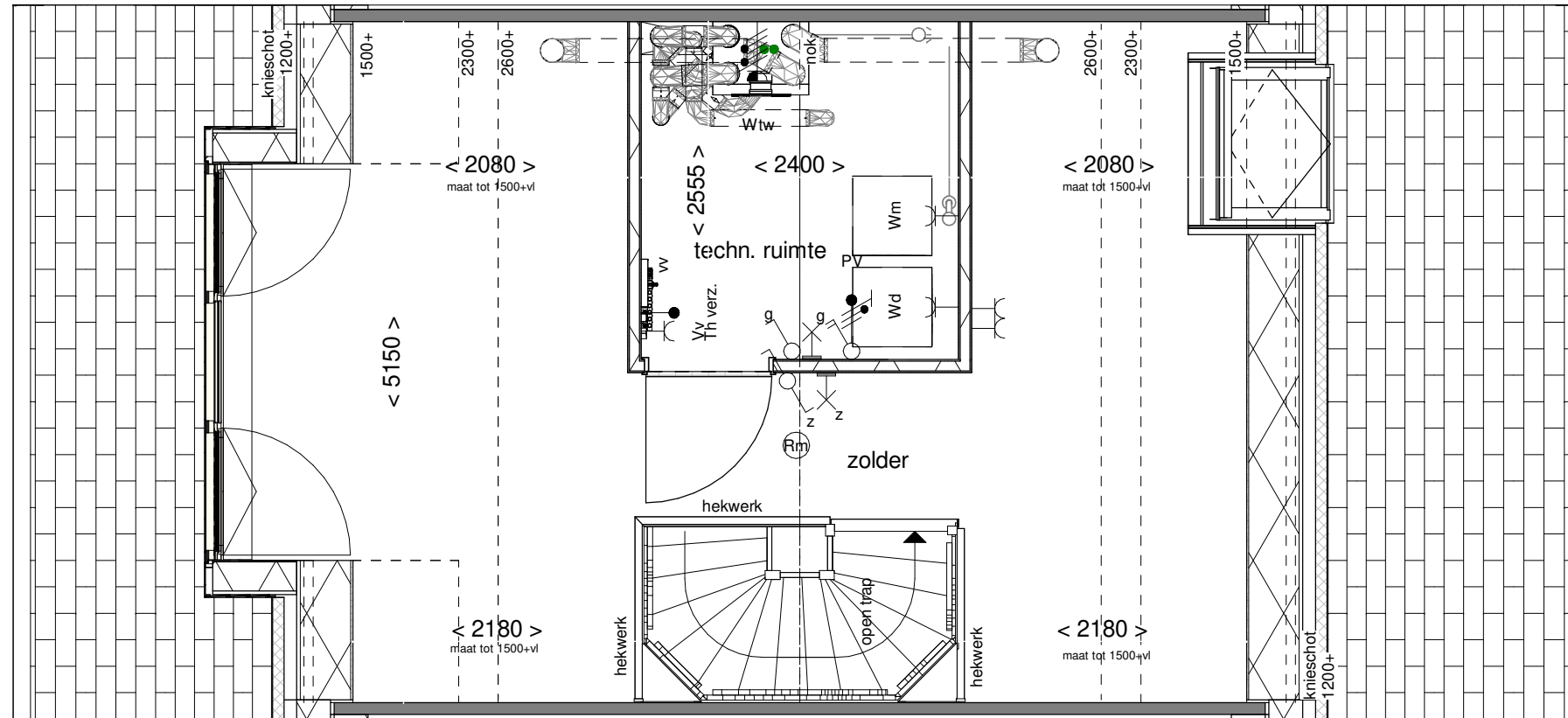

Achtergevel schaal 1:100

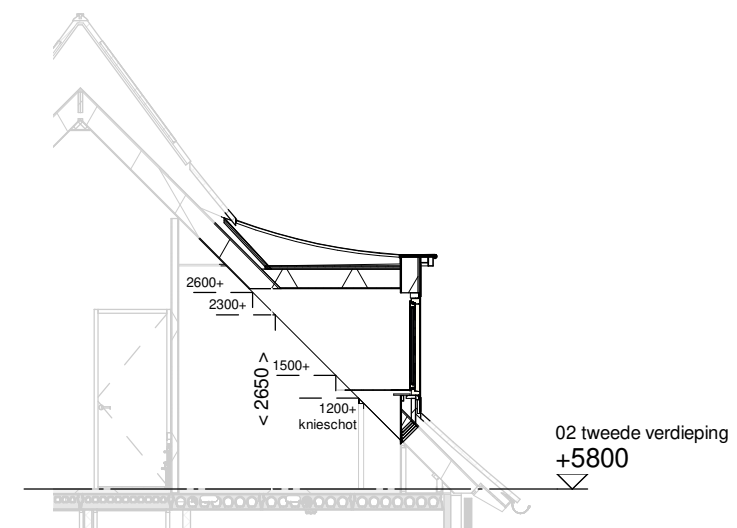

Doorsnede schaal 1:100

**ALLEMAAL  
YIELEYAAL**

Optie: Dakkapel  
achtergevel 3000mm

Woningtype: X54

Bouwnummer: -

Optienummer: 1.B.X.34

Schaal: 1:50 / 1:100

Datum: 29-09-2021

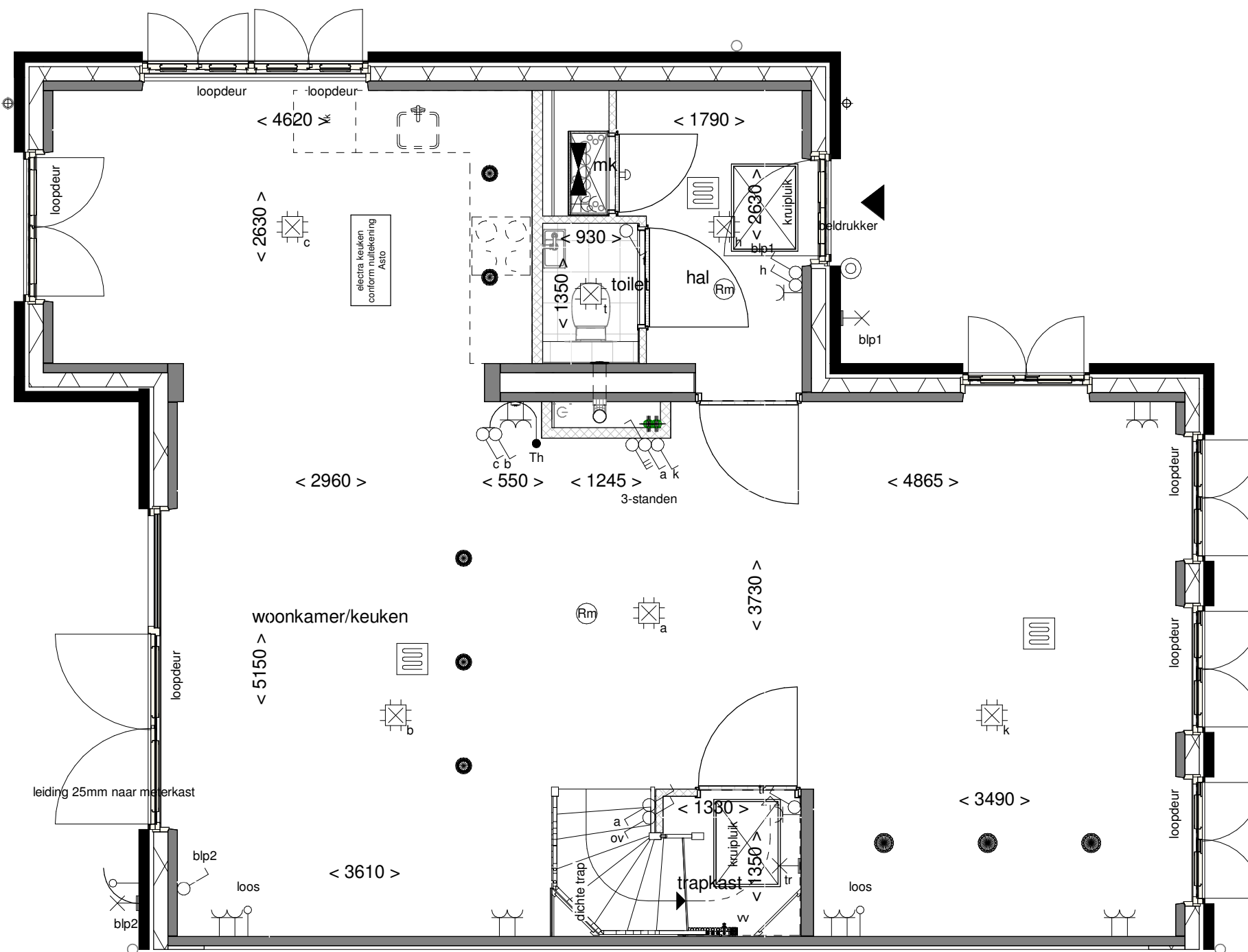

**ALLEMAAL  
YIELEYAAL**

Optie: Keuken in zij-uitbouw

Woningtype: X54U

Bouwnummer: -

Optienummer: 1.C.X.12

Schaal: 1:50

Datum: 29-09-2021

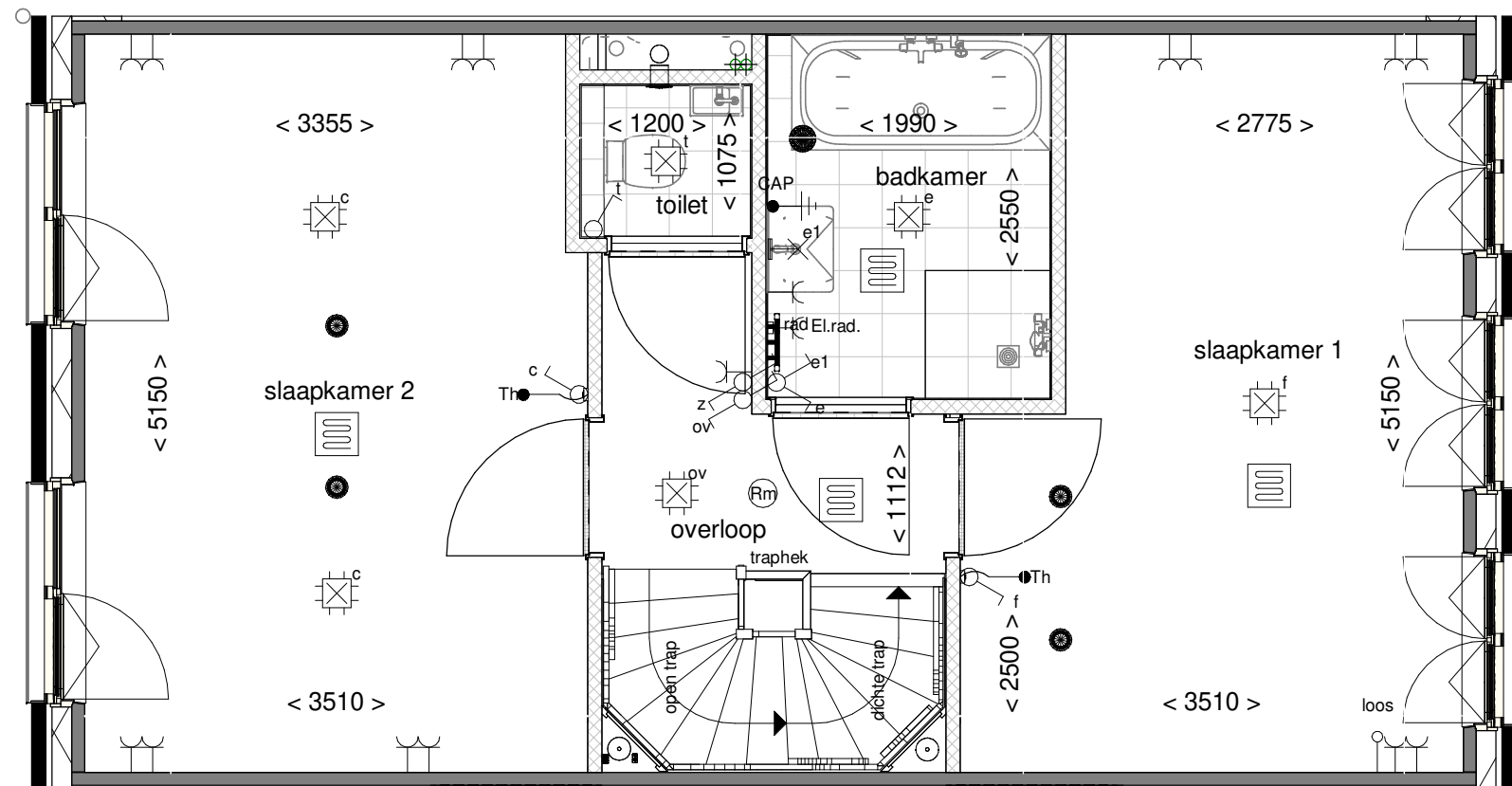

**ALLEMAAL  
YIELEYAAL**

Optie: Samenvoegen  
slaapkamer 2 en 3

Woningtype: X54

Bouwnummer: -

Optienummer: 1.C.X.30

Schaal: 1:50

Datum: 29-09-2021

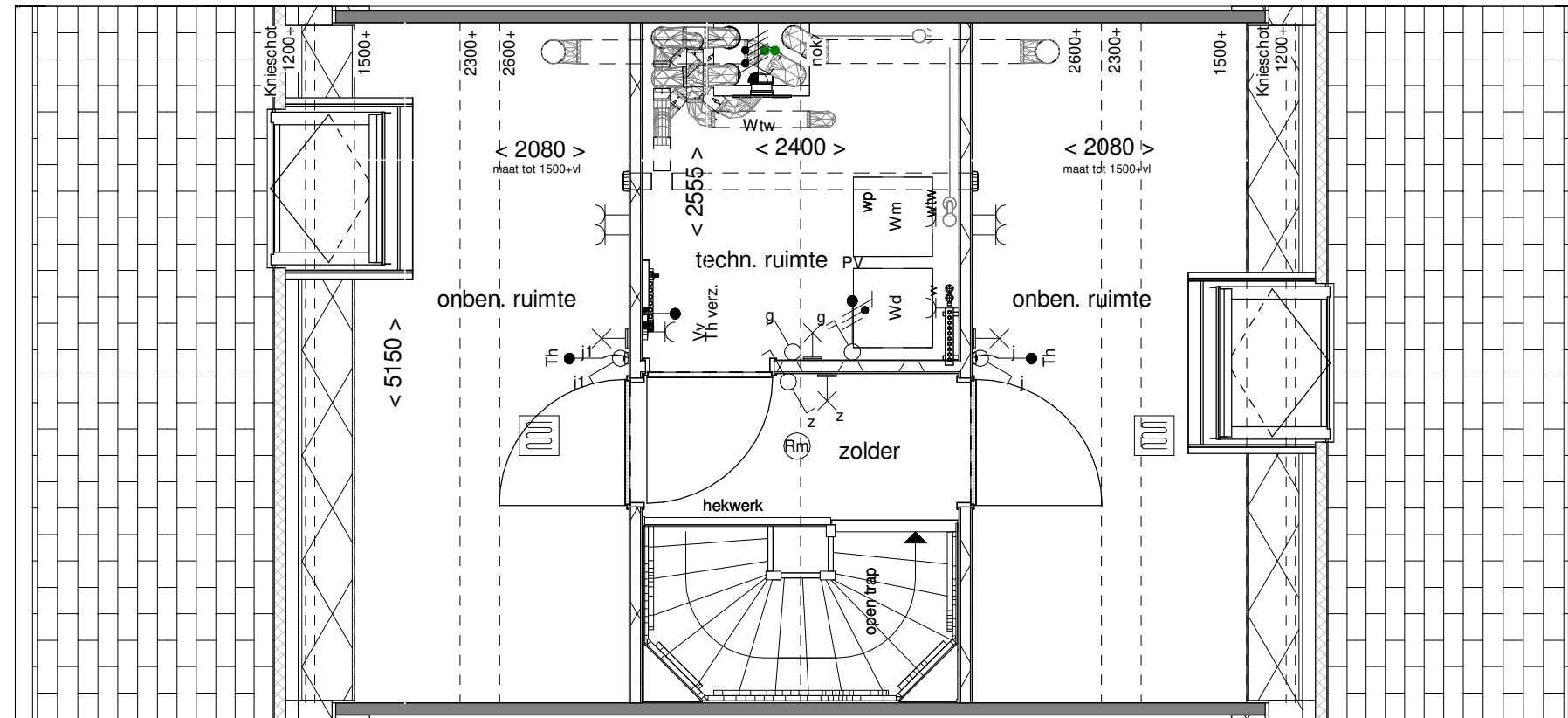

**ALLEMAAL  
YIELEYAAL**

Optie: Indeling techn.- en 2  
onb. ruimtes

Woningtype: X54

Bouwnummer: -

Optienummer: 1.C.X.76

Schaal: 1:50

Datum: 29-09-2021

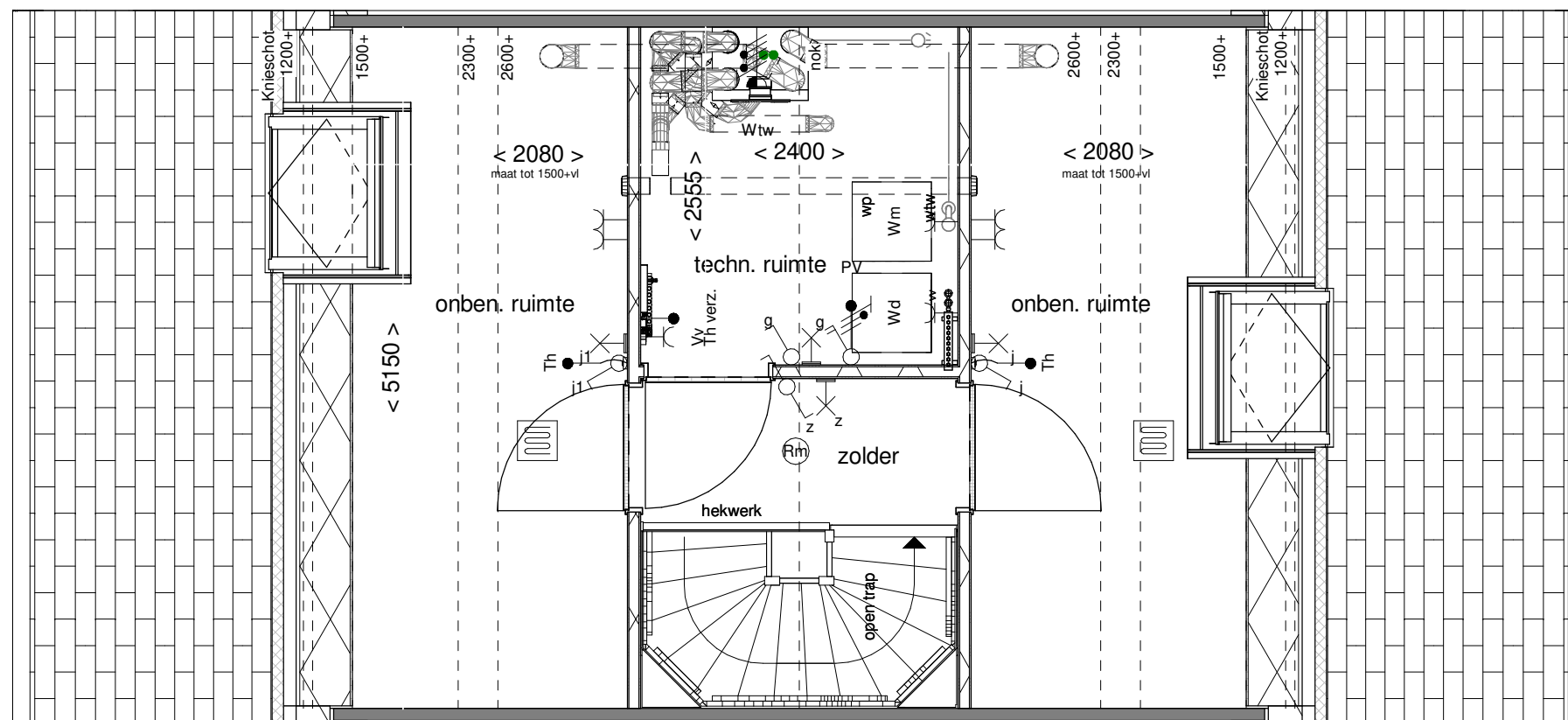

**ALLEMAAL  
YIELEYAAL**

Optie: Indeling techn.- en 2  
onb. ruimtes

Woningtype: X54

Bouwnummer: -

Optienummer: 1.C.X.78

Schaal: 1:50

Datum: 29-09-2021