

**ALLEMAAL
YIELEYAAL**

Tekening: **Situatie totaal**

Woningtype:

Bouwnummer:

Bladnummer: **VT-S-01**

Schaal: **1:1000**

Datum: **27-10-2021**

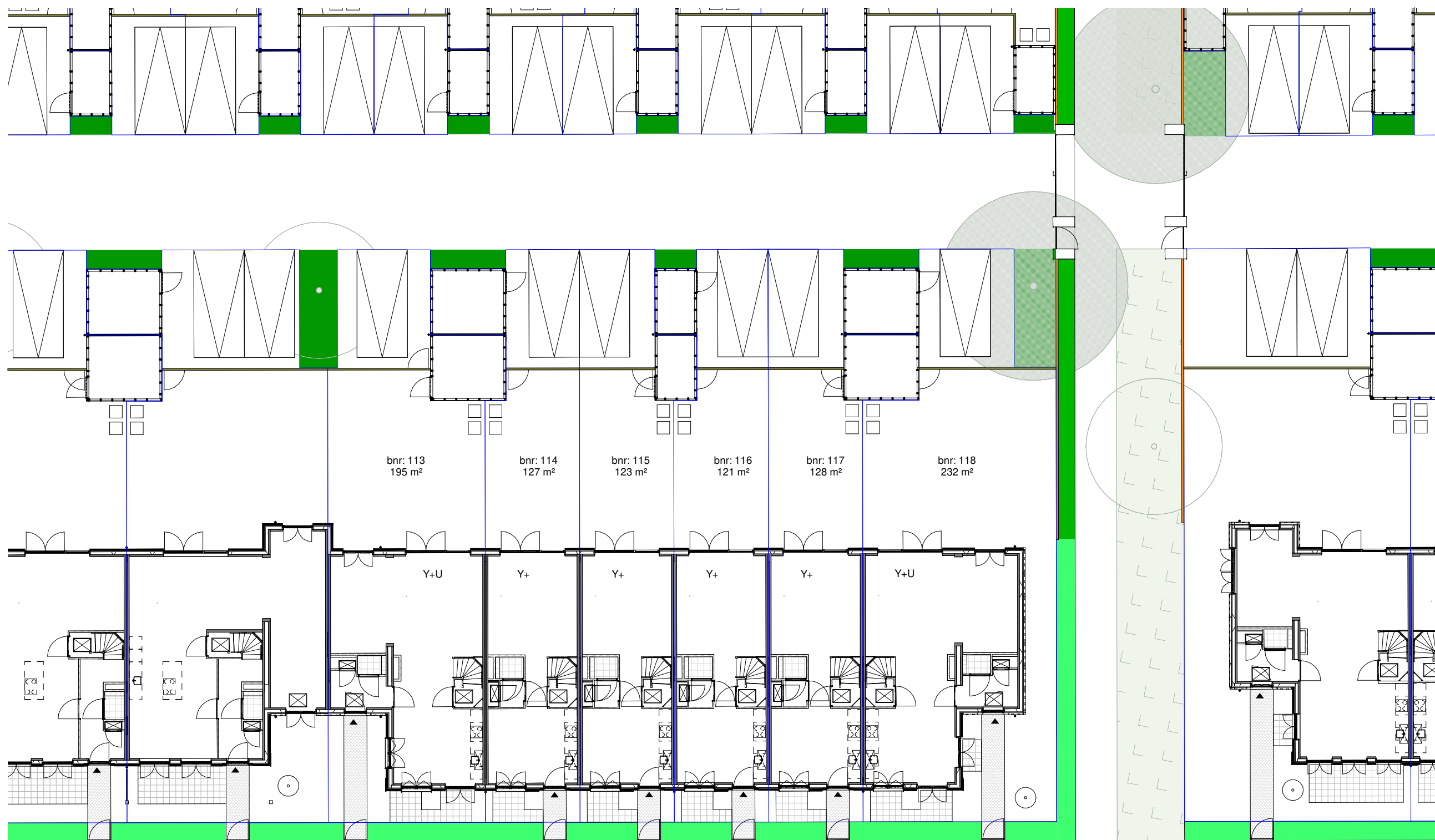

Renvooi

-  - entree woning
-  - parkeervak eigen terrein
-  - erfgrans
-  - beplanting
type n.t.b. koper
-  - opstelplaats klike
-  - tuinhekje
-  - klinkerbestrating
-  - betontegels
300x300mm
-  - groen strook
-  - haag h=900mm
-  - haag h=1800mm
-  - bamboehok h=1800mm
-  - gaashek met klimplanten
en poort h=1600mm

parkeerplekken en posities
bomen en struiken zijn indicatief

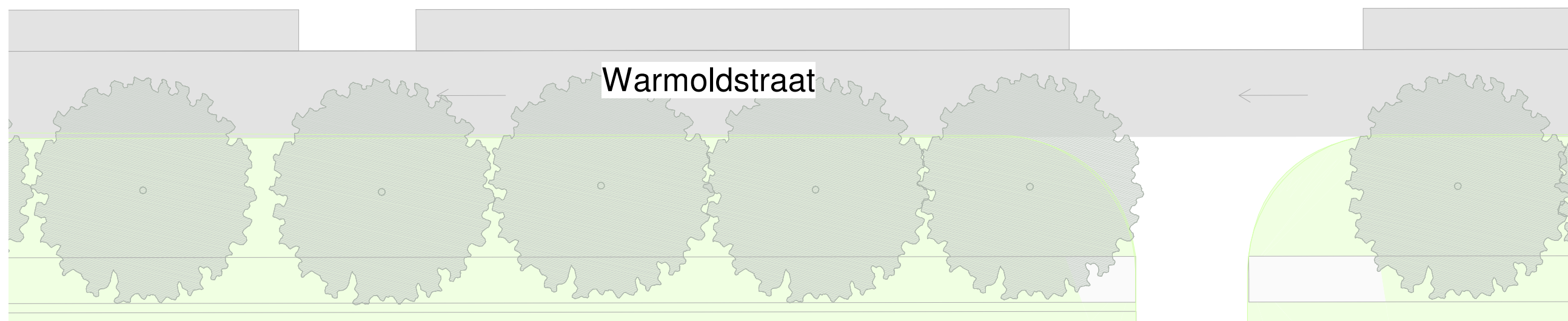

**ALLEMAAL
YIELEYAAL**

Tekening: Situatie Blok D4

Woningtype: Y+U, Y+











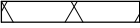

Bouwnummer: 113-118

Bladnummer: VT-S-10



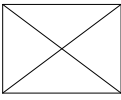

























Schaal: 1:200

Datum: 27-10-2021

Renvooi bouwkundig

	metselwerk kleur A
	dakpannen kleur oranje
	entree woning
	metselwerk
	isolatie
	dragende wand
	niet dragende binnenwand
	binnendeurkozijn (met bovenlicht)
	kruipluik
	opstelplaats wasmachine
	opstelplaats wasdroger
	
	principe opstelling keukenblok

Renvooi installaties

	aansluitpunt licht
	aansluitpunt licht, wand
	centraaldoos met lichtpunt
	armatuur aan de wand
	rookmelder
	aansluitpunt niet bedraad
	verdeelinrichting / meterkast / groepenkast
	beldrukker
	schel
	schakelaar, 1-polig
	werkschakelaar tbv PV-panelen
	schakelaar, 3-polig
	schakelaar, wissel
	schakelaar, kruis
	schakelaar, serie
	wandcontactdoos 1-voudig met beschermingscontact
	wandcontactdoos 2-voudig met beschermingscontact, verticaal
	wandcontactdoos 2-voudig met beschermingscontact
	thermostaatleiding, bedraad
	mechanische ventilatie-unit incl. warmteterugwinunit
	warmtepomp
	inblaasventiel mechanische ventilatie
	uitblaasventiel mechanische ventilatie
	verdeler vloerverwarming
	ruimte voorzien van vloerverwarming
	elektrische radiator
	kanalen in het zicht
	onbenoemde ruimte volgens krijstreepmethode

Disclaimer

De op deze tekeningen aangegeven maten zijn circa maten in millimeters en tussen de wanden / vloeren gemeten, waarbij geen rekening is gehouden met enige wandafwerking, plinten, aftimmering, ect. In verband met de nauwkeurige uitwerking van details, constructie, maatvoering, materialen e.d. kunnen er kleine afwijkingen ontstaan ten opzichte van de nu vermelde gegevens. Deze geringe afwijkingen geven geen aanleiding tot verrekening. Aan de op deze tekening aangegeven maten kunnen derhalve geen rechten worden ontleend. De op deze tekeningen aangegeven maatvoering is niet geschikt voor opdrachten aan derden door koper(s). De posities van aansluitingen en installatie onderdelen zijn indicatief op tekening aangegeven. De exacte aantallen en posities zullen na berekening in het werk door de installateurs worden bepaald en kunnen afwijken van deze tekening.

**ALLEMAAL
YIELEYAAL**

Tekening: Renvooi

Woningtype: -

Bouwnummer: -

Bladnummer: VT-0-00c

Schaal: -

Datum: 27-10-2021



Type: Y+U
bwnr: 113

Type: Y+
bwnr: 114

Type: Y+
bwnr: 115

Type: Y+
bwnr: 116

Type: Y+
bwnr: 117

Type: Y+U
bwnr: 118



Type: Y+U
bwnr: 118

Type: Y+
bwnr: 117

Type: Y+
bwnr: 116

Type: Y+
bwnr: 115

Type: Y+
bwnr: 114

Type: Y+U
bwnr: 113

ALLEMAAL
YIELEYAAL

Tekening: Gevels blok D4

Woningtype: Y+, Y+U

Bouwnummer: 113 t/m 118

Bladnummer: VT-D4-00a

Schaal: 1:150

Datum: 27-10-2021



Linker zijgevel



Rechter zijgevel

**ALLEMAAL
YIELEYAAL**

Tekening: Zijgevels blok D4

Woningtype: Y, Y+U

Bouwnummer: 113 t/m 118

Bladnummer: VT-D4-00b

Schaal: 1:100

Datum: 27-10-2021

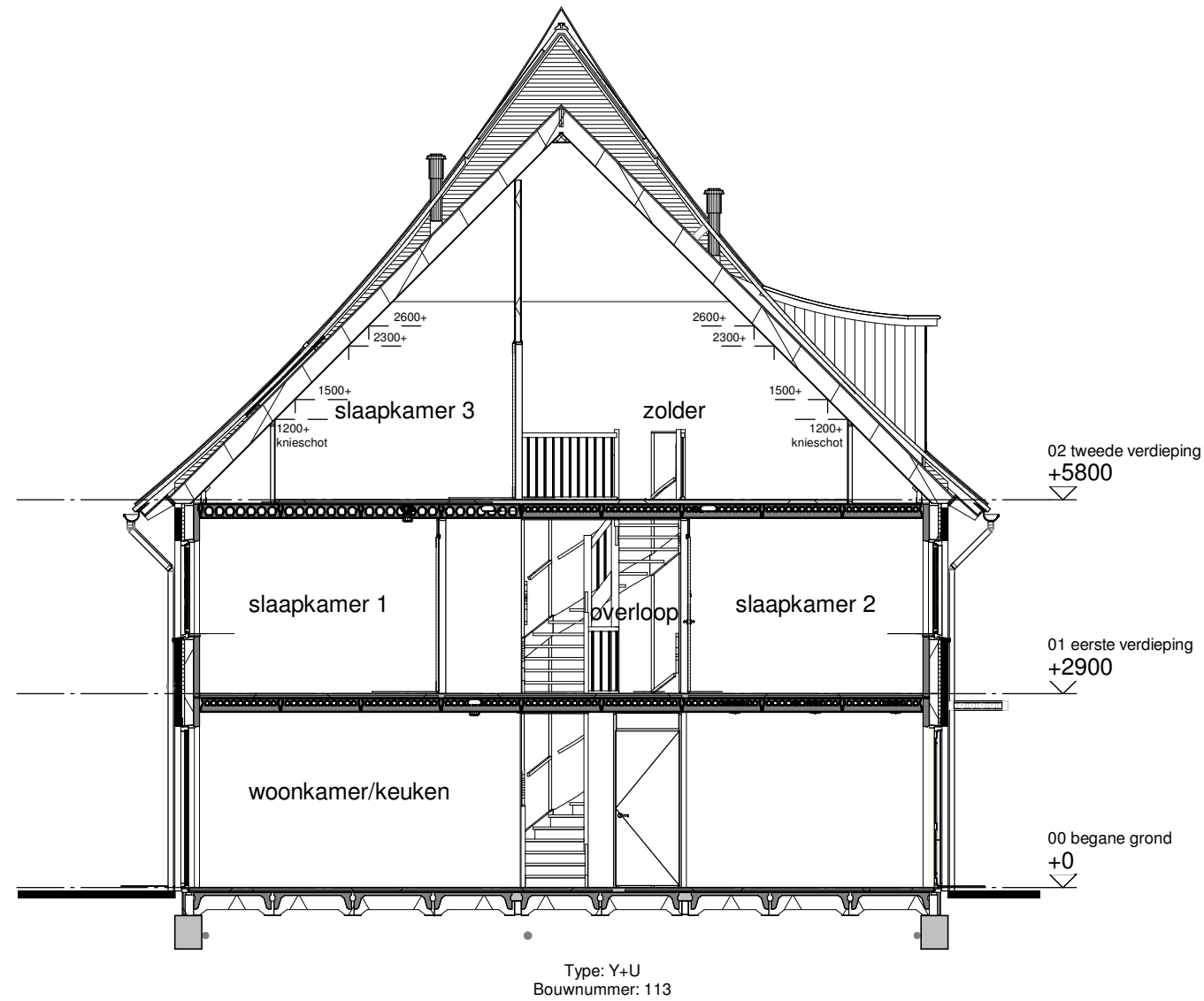

Doorsnede A

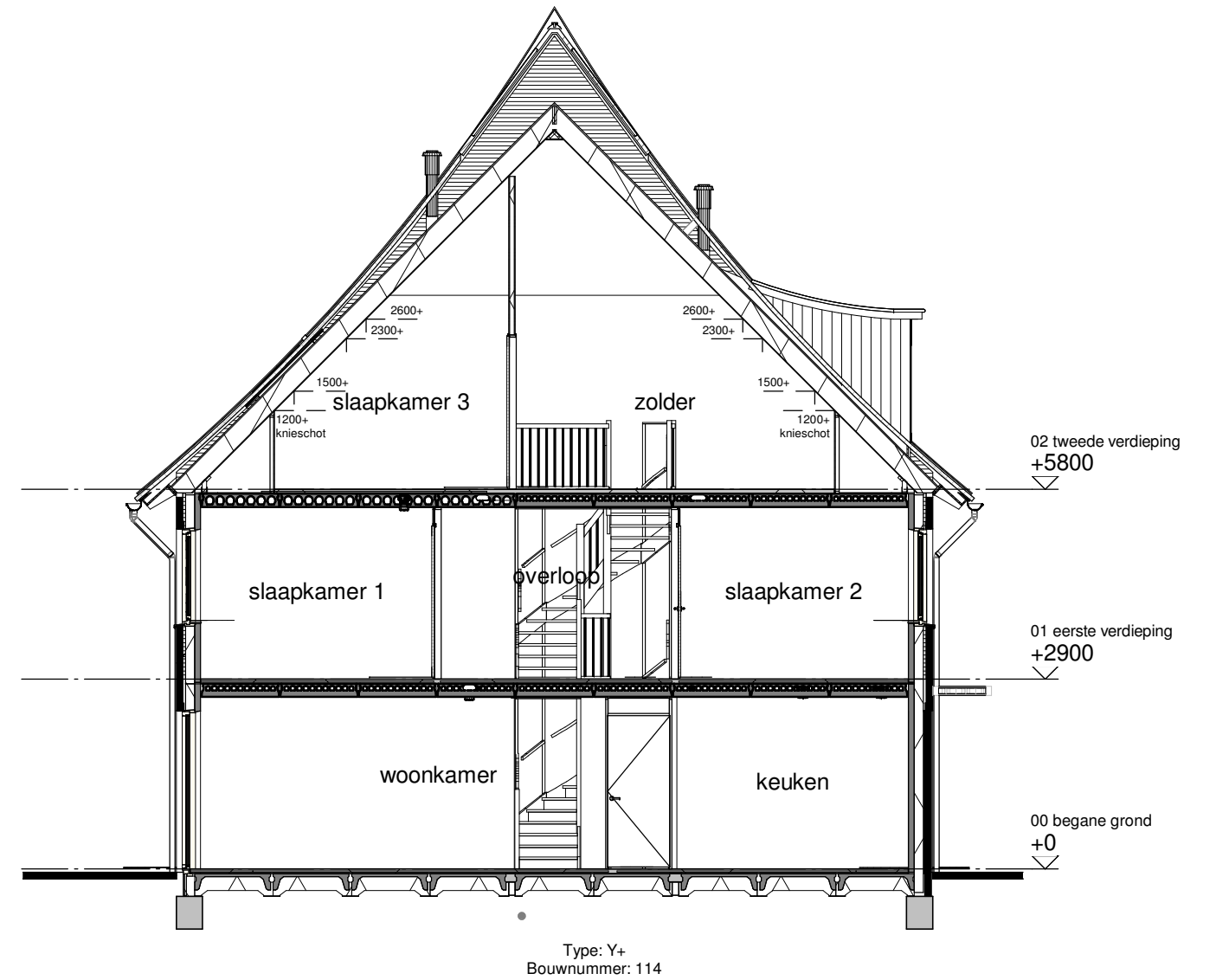

Doorsnede B

ALLEMAAL
YIELEYAAL

Tekening: Doorsneden blok D4

Woningtype: Y+U, Y+

Bouwnummer: 113-118

Bladnummer: VT-D4-00c

Schaal: 1:100

Datum: 27-10-2021

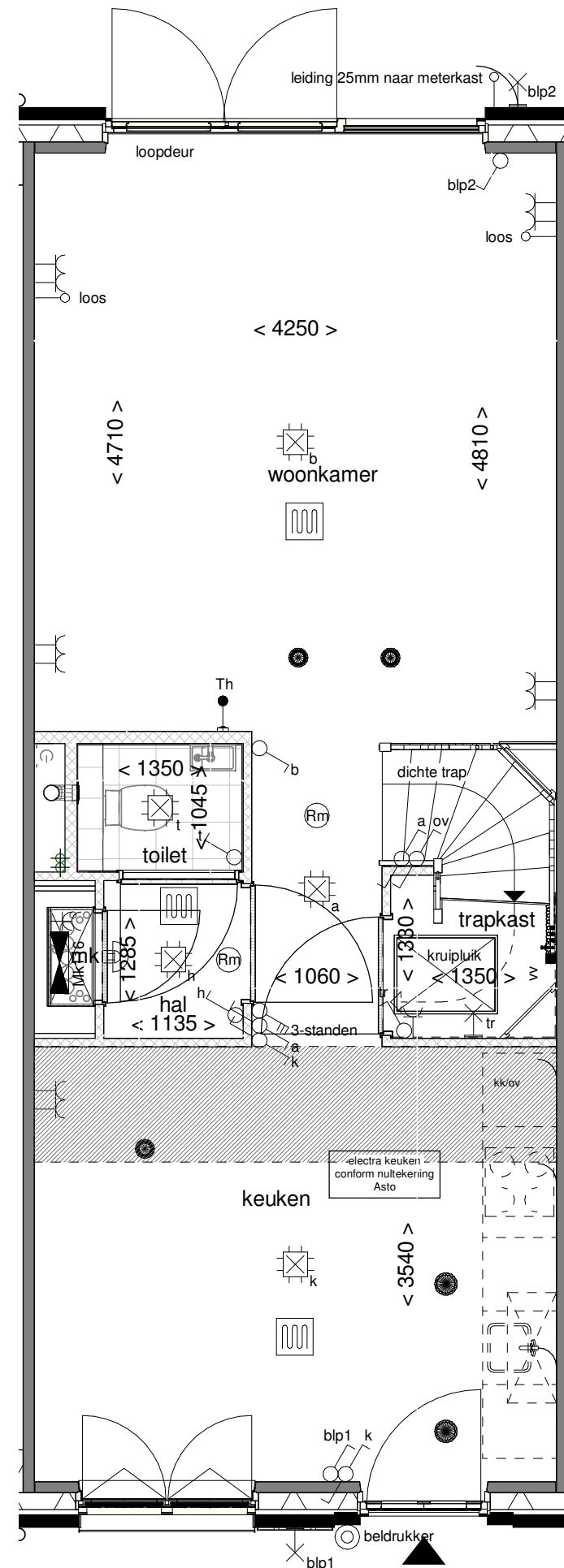

**ALLEMAAL
YIELEYAAL**

Tekening: Begane grond

Woningtype: Y+

Bouwnummer: 116

Bladnummer: VT-D4-116a

Schaal: 1:50

Datum: 27-10-2021

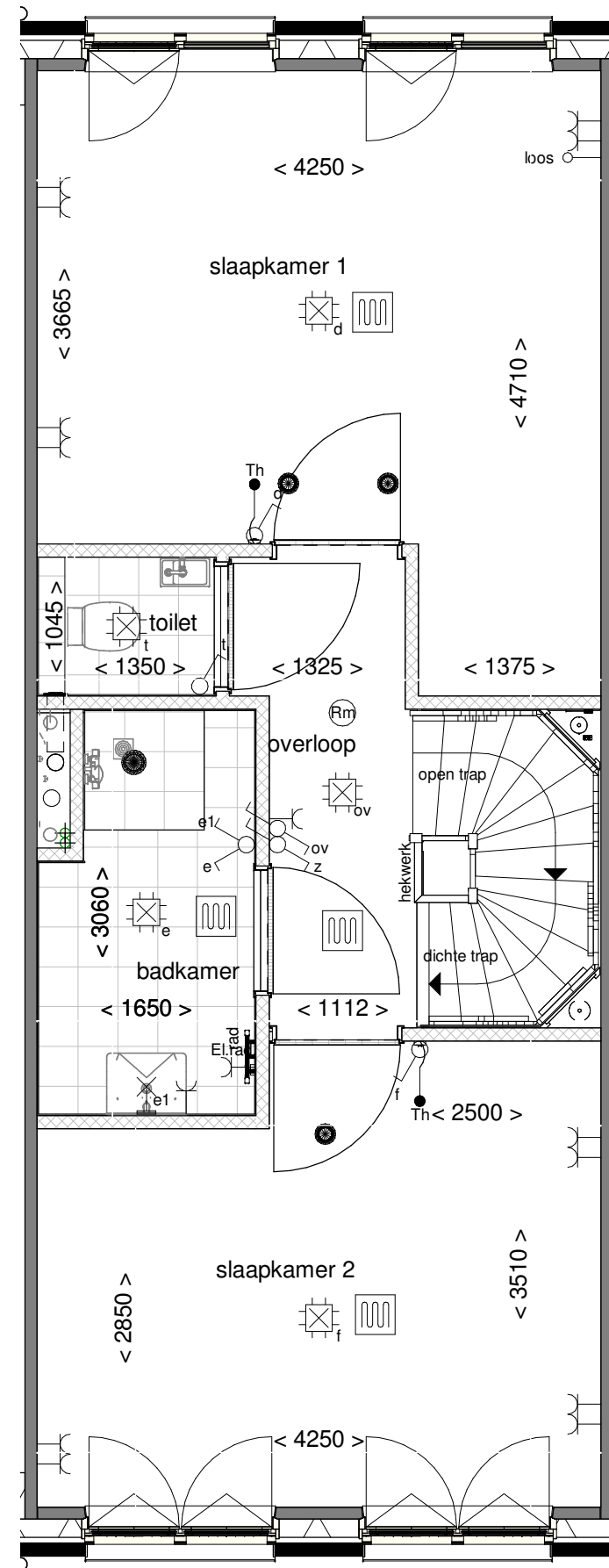

**ALLEMAAL
YIELEYAAL**

Tekening: Eerste verdieping

Woningtype: Y+

Bouwnummer: 116

Bladnummer: VT-D4-116b

Schaal: 1:50

Datum: 27-10-2021

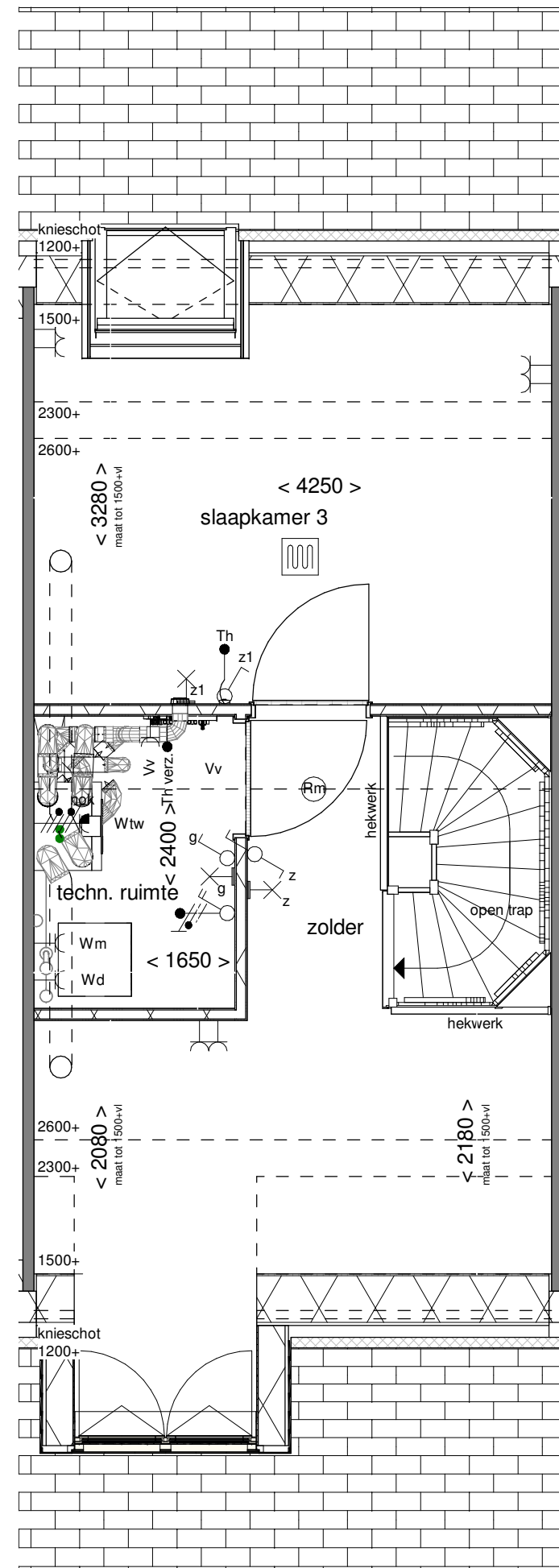

**ALLEMAAL
YIELEYAAL**

Tekening: Tweede verdieping

Woningtype: Y+

Bouwnummer: 116

Bladnummer: VT-D4-116c

Schaal: 1:50

Datum: 27-10-2021

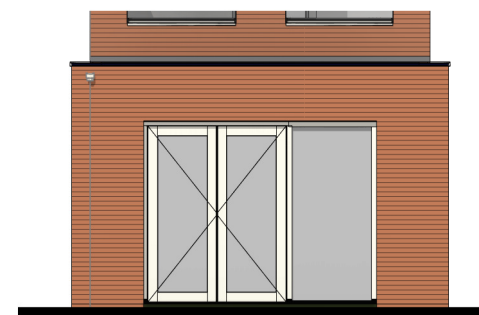
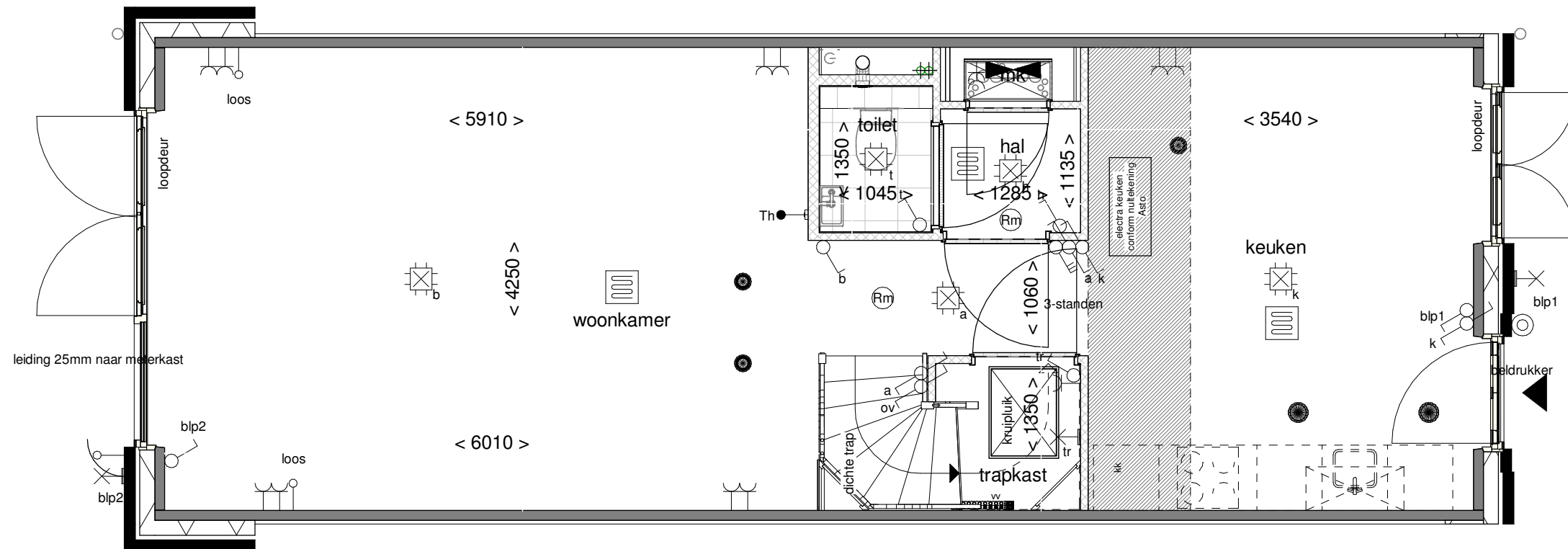

Achtergevel schaal 1:100

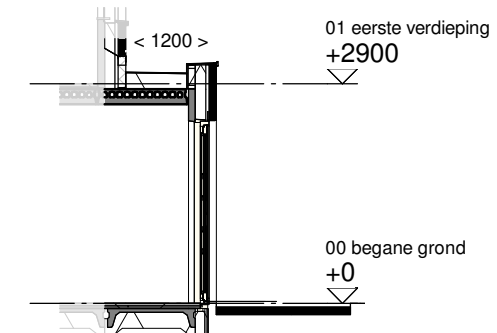

Doorsnede schaal 1:100

**ALLEMAAL
YIELEYAAL**

Optie: **Uitbouw achtergevel
1200mm**

Woningtype: **Y45+**

Bouwnummer: -

Optienummer: **0.A.Y.14**

Schaal: **1:50 / 1:100**

Datum: **29-09-2021**

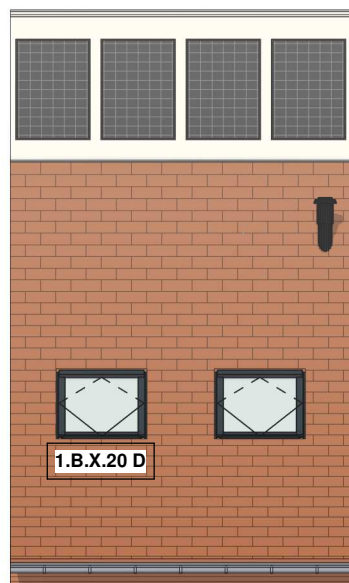
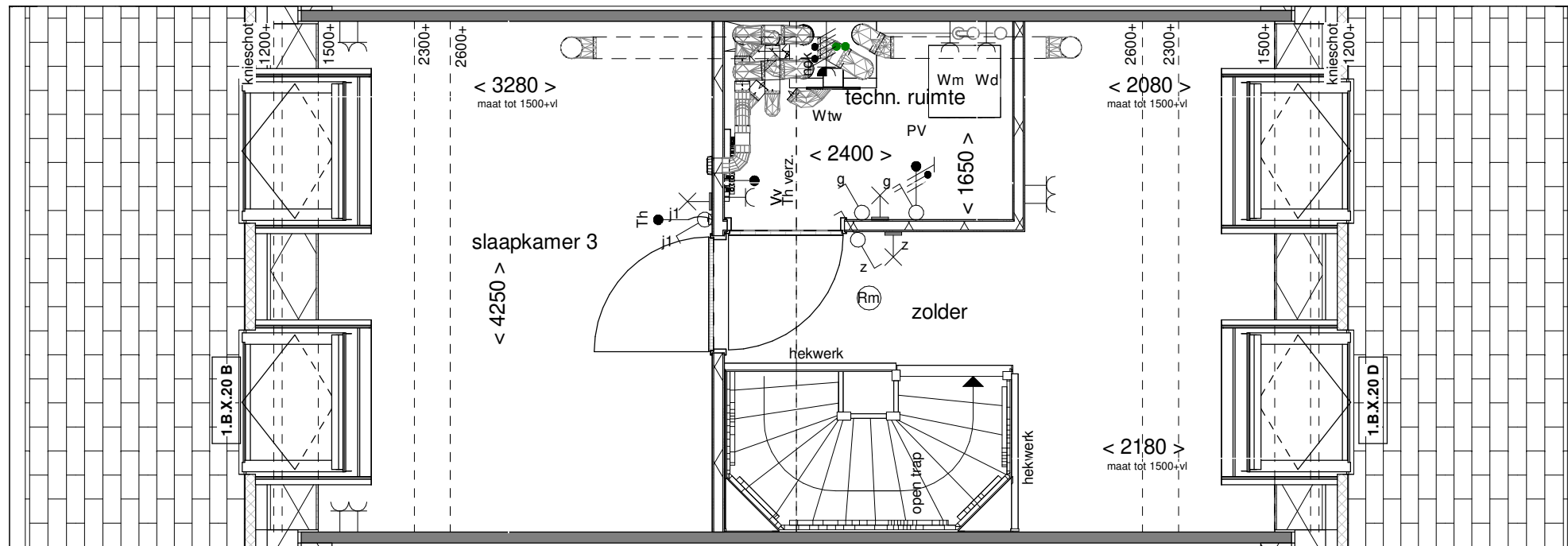

Voorgevel schaal 1:100

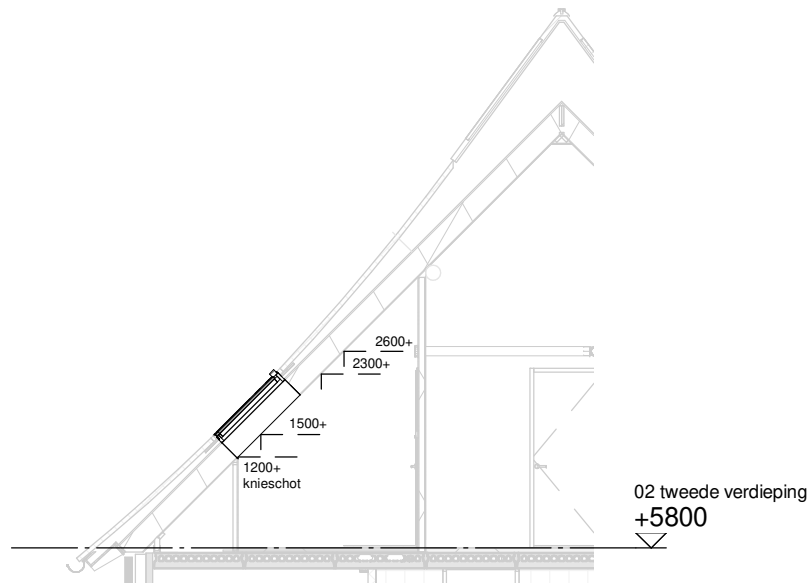

Doorsnede schaal 1:100

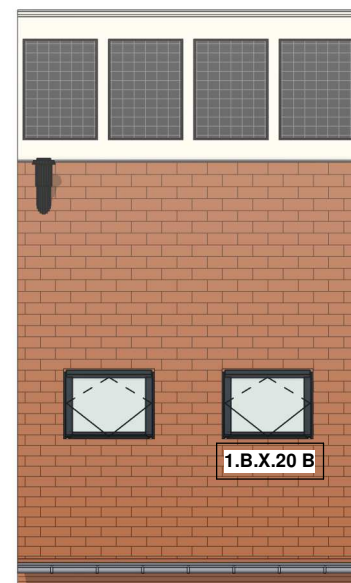

Achtergevel schaal 1:100

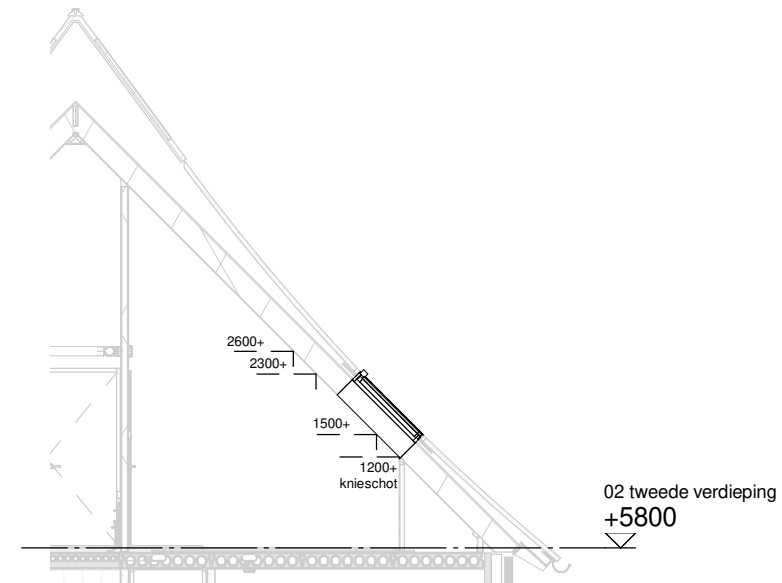

Doorsnede schaal 1:100

**ALLEMAAL
YIELEYAAL**

Optie: Dakramen voor- en achtergevel

Woningtype: Y45+

Bouwnummer: -

Optienummer: 1.B.X.20

Schaal: 1:50 / 1:100

Datum: 29-09-2021

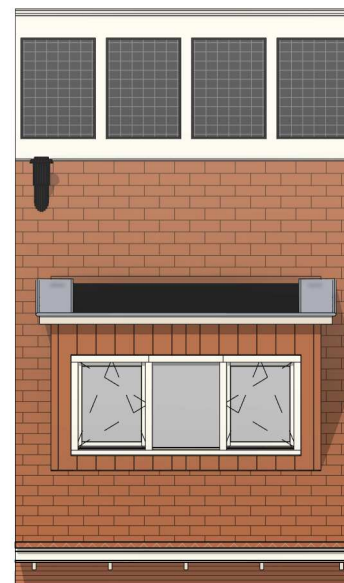
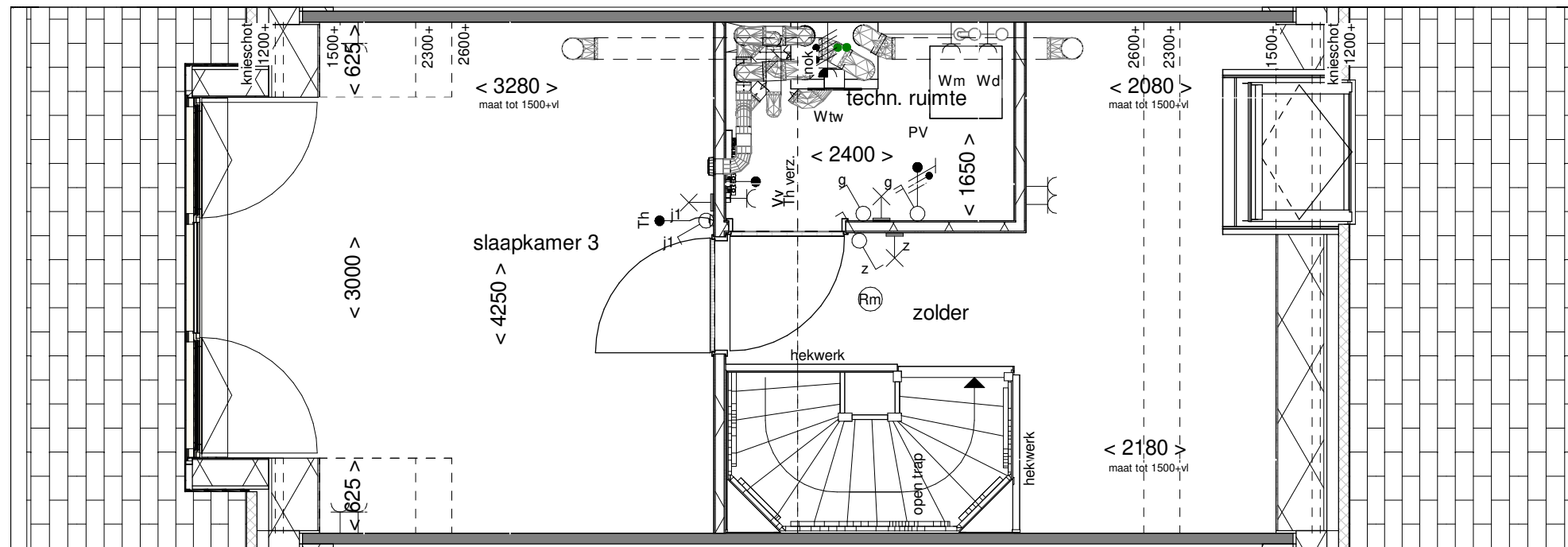

Achtergevel schaal 1:100

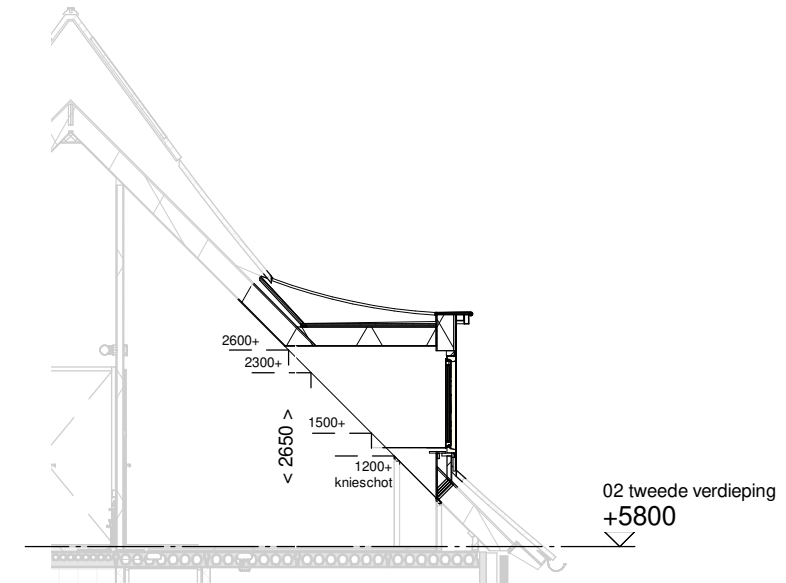

Doorsnede schaal 1:100

**ALLEMAAL
YIELEYAAL**

Optie: Dakkapel
achtergevel 3000mm

Woningtype: Y45+

Bouwnummer: -

Optienummer: 1.B.X.34

Schaal: 1:50 / 1:100

Datum: 29-09-2021

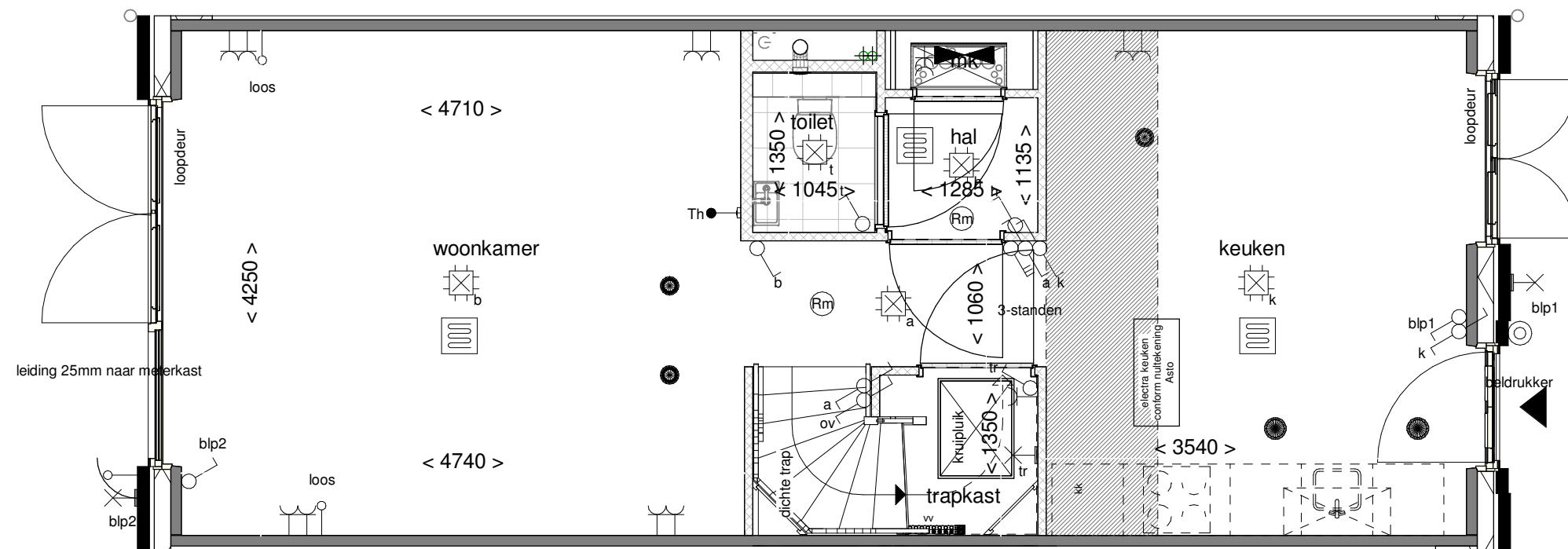

ALLEMAAL
YIELEYAAL

Optie: Wand naast trap

Woningtype: Y45+

Bouwnummer: -

Optienummer: 1.C.Y.10

Schaal: 1:50

Datum: 29-09-2021

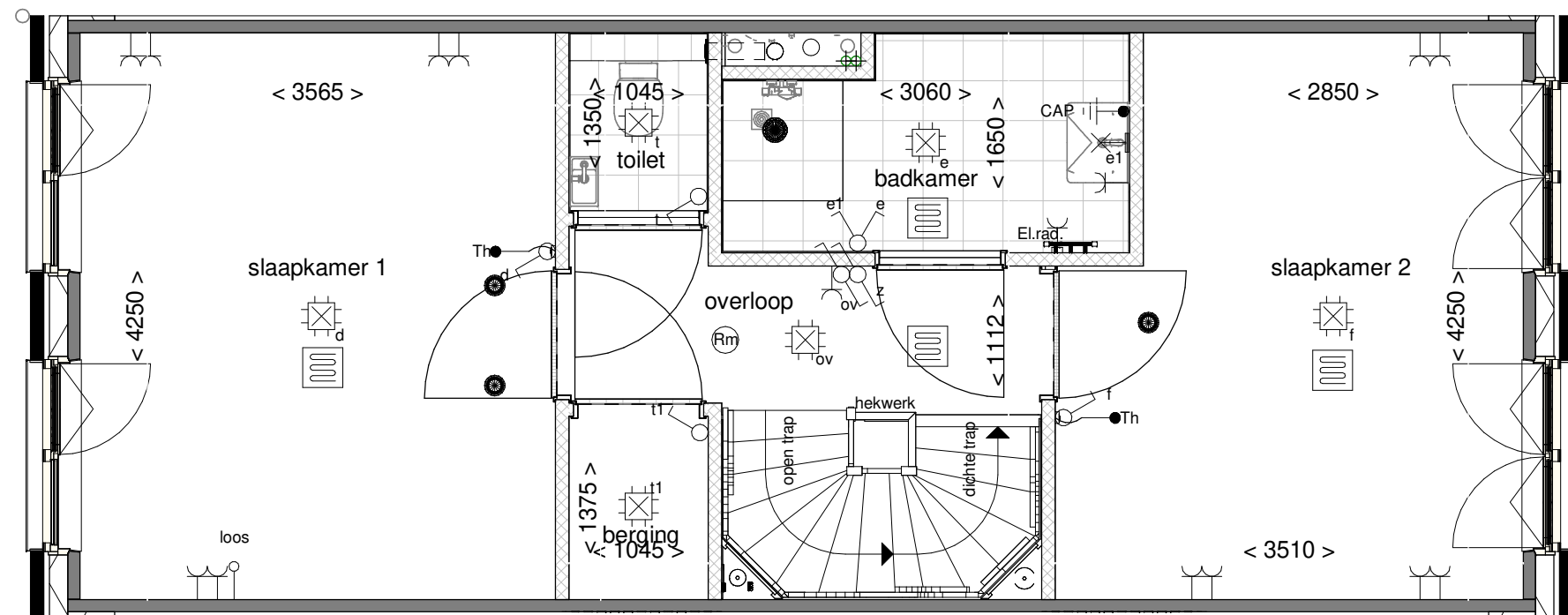

**ALLEMAAL
YIELEYAAL**

Optie: Kast op overloop

Woningtype: Y45+

Bouwnummer: -

Optienummer: 1.C.Y.34

Schaal: 1:50

Datum: 29-09-2021

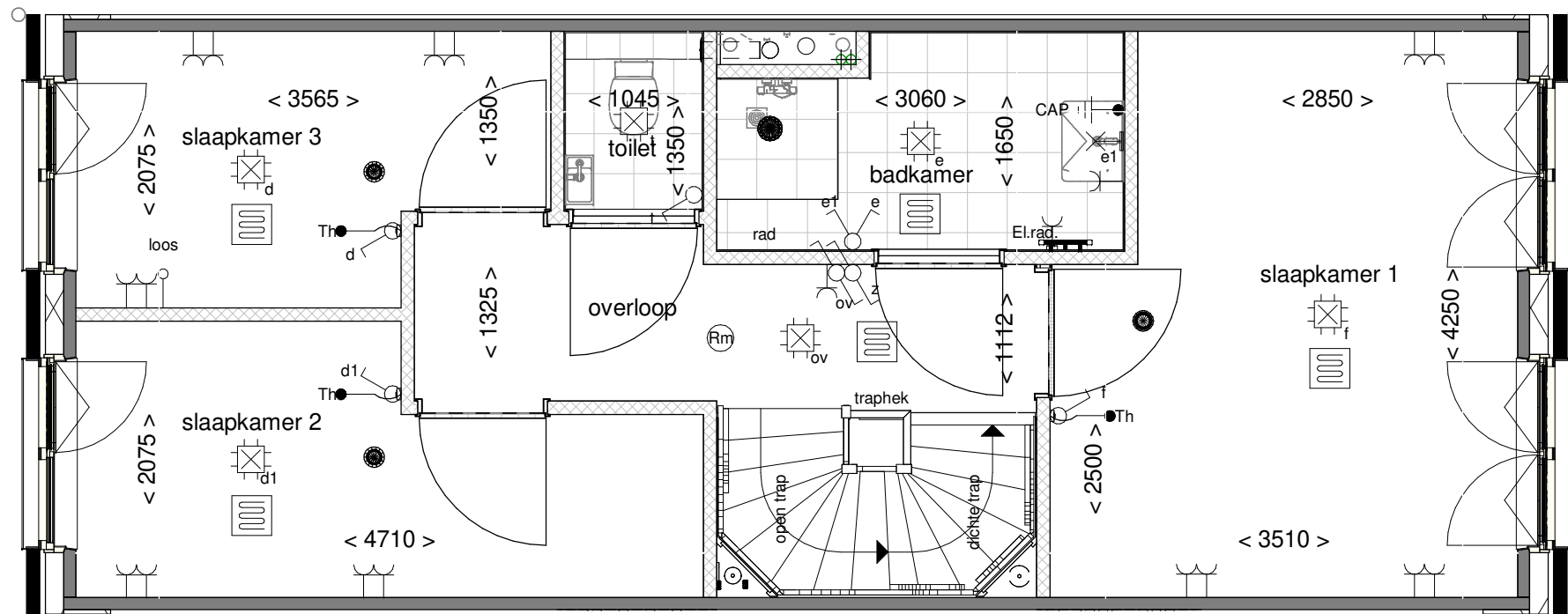

**ALLEMAAL
YIELEYAAL**

Optie: Twee slaapkamers
achterzijde

Woningtype: Y45+

Bouwnummer: -

Optienummer: 1.C.Y.36

Schaal: 1:50

Datum: 29-09-2021

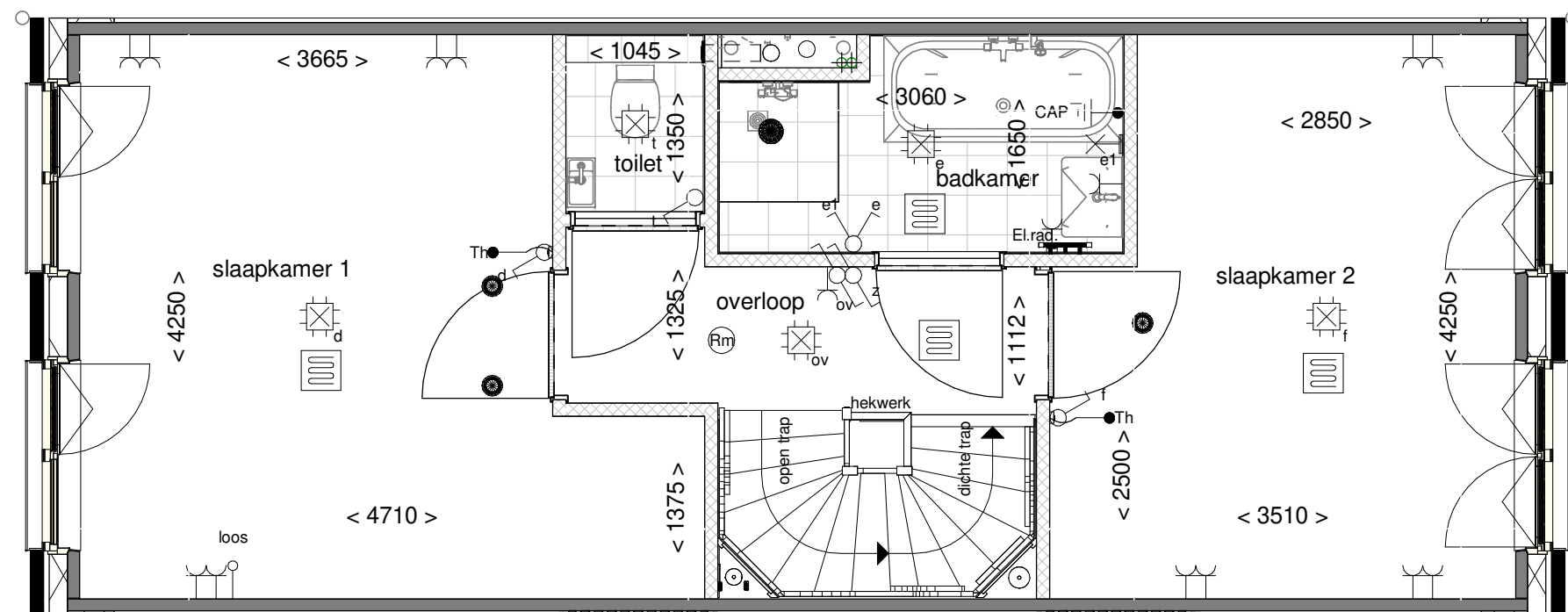

**ALLEMAAL
YIELEYAAL**

Optie: Bad in badkamer

Woningtype: Y45+

Bouwnummer: -

Optienummer: 1.C.Y.40

Schaal: 1:50

Datum: 29-09-2021

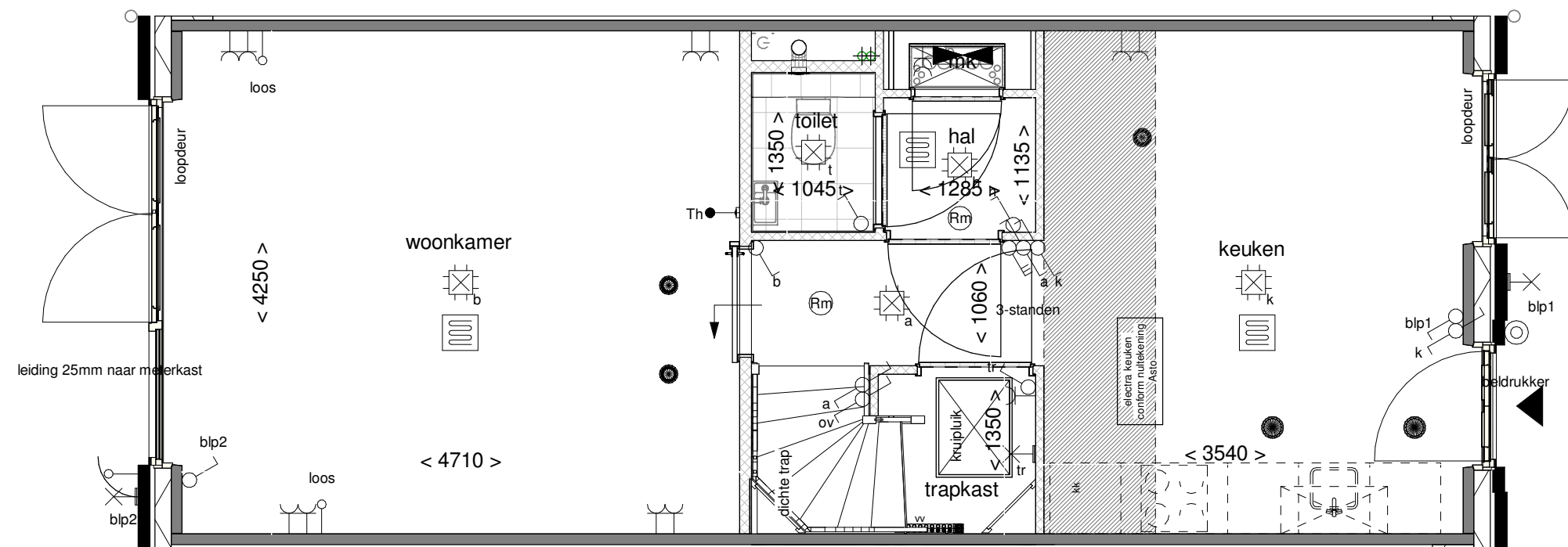

**ALLEMAAL
YIELEYAAL**

Optie: Schuifdeur tussen woonk. en keuken

Woningtype: Y45+

Bouwnummer: -

Optienummer: 1.C.Y.42

Schaal: 1:50

Datum: 29-09-2021

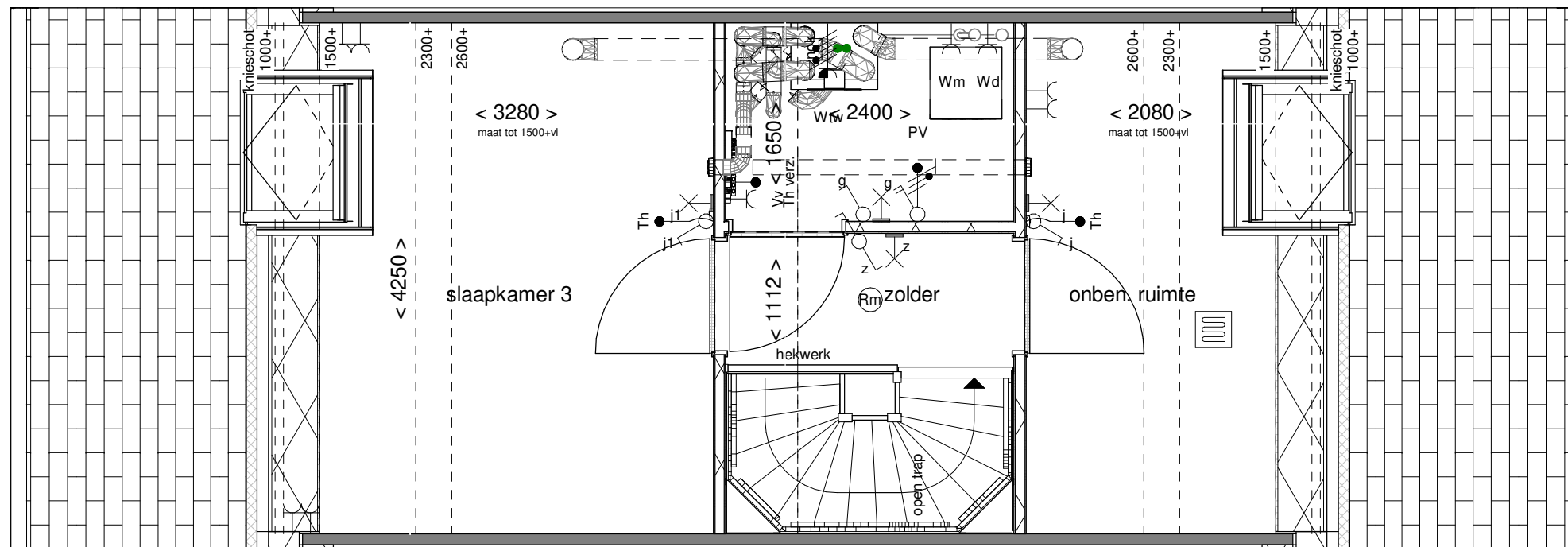

**ALLEMAAL
YIELEYAAL**

Optie: Techn.- en onben.
ruimte en slaapkamer

Woningtype: Y45+

Bouwnummer: -

Optienummer: 1.C.Y.78

Schaal: 1:50

Datum: 29-09-2021