

**ALLEMAAL  
YIELEYAAL**

Tekening: Situatie totaal

Woningtype:

Bouwnummer:

Bladnummer: VT-S-01

Schaal: 1:1000

Datum: 27-10-2021

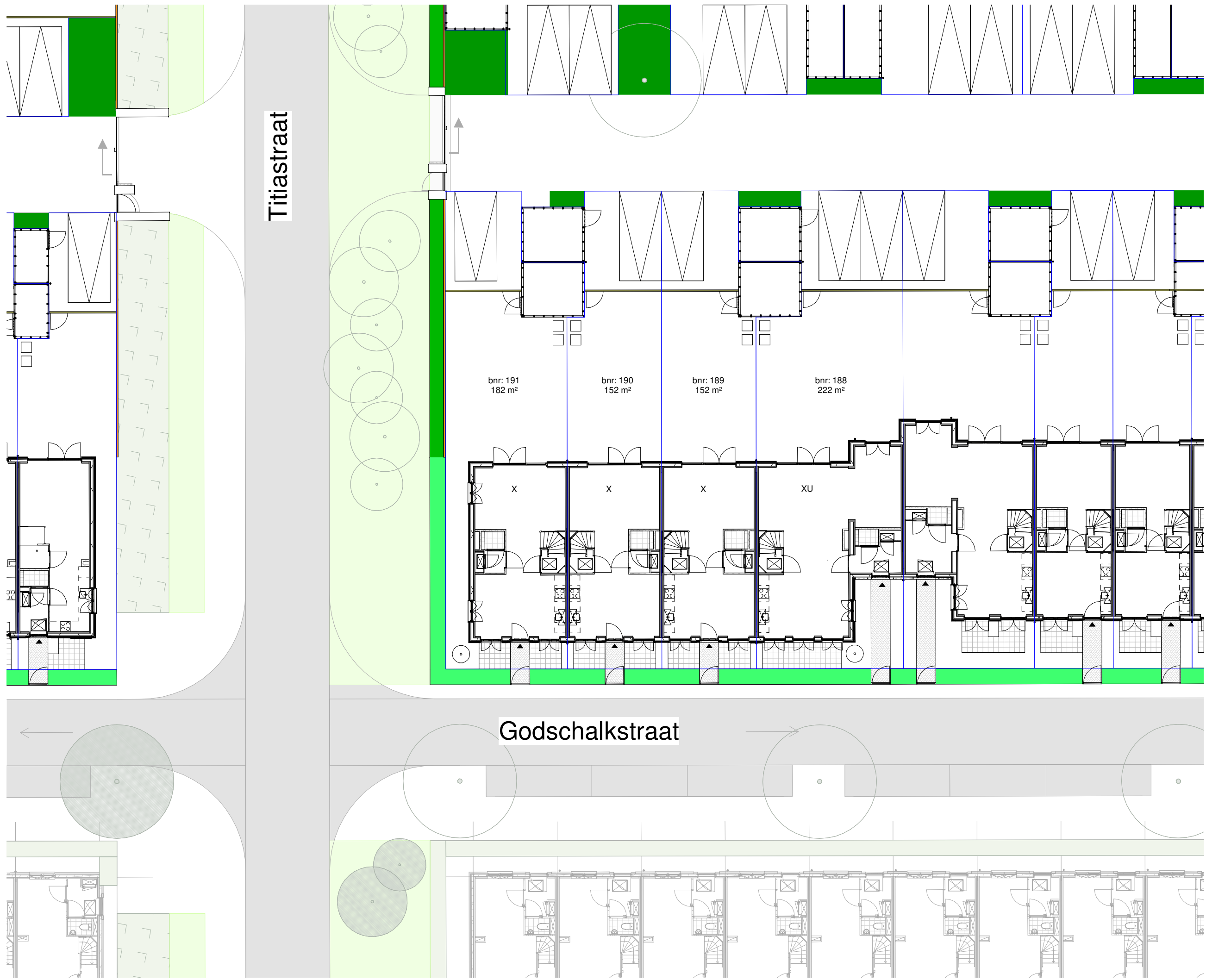

**Renvooi**

-  - entree woning
-  - parkeervak eigen terrein
-  - erfgrans
-  - beplanting  
type n.t.b. koper
-  - opstelplaats kliko
-  - tuinhekje
-  - klinkerbestrating
-  - betontegels  
300x300mm
-  - groen strook
-  - haag h=900mm
-  - haag h=1800mm
-  - bamboehok h=1800mm
-  - gaashek met klimplanten  
en poort h=1600mm













parkeerplekken en posities  
bomen en struiken zijn indicatief

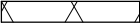



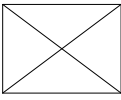

























**ALLEMAAL  
YIELEYAAL**

|             |                  |
|-------------|------------------|
| Tekening:   | Situatie Blok I3 |
| Woningtype: | XU,X             |
| Bouwnummer: | 188-191          |
| Bladnummer: | VT-S-16          |
| Schaal:     | 1:200            |
| Datum:      | 27-10-2021       |

## Renvooi bouwkundig

|   |                                   |
|---|-----------------------------------|
|    | metselwerk kleur A                |
|    | dakpannen kleur oranje            |
|    | entree woning                     |
|    | metselwerk                        |
|    | isolatie                          |
|    | dragende wand                     |
|    | niet dragende binnenwand          |
|    | binnendeurkozijn (met bovenlicht) |
|    | kruipluik                         |
|   | opstelplaats wasmachine           |
|  | opstelplaats wasdroger            |
|  |                                   |
|  | principe opstelling keukenblok    |

## Renvooi installaties

|   |   |
|---|---|
|    | aansluitpunt licht  |
|    | aansluitpunt licht, wand                                    |
|    | centraaldoos met lichtpunt                                  |
|    | armatuur aan de wand  |
|    | rookmelder  |
|    | aansluitpunt niet bedraad                                   |
|    | verdeelinrichting / meterkast / groepenkast                 |
|    | beldrukker  |
|    | schel   |
|    | schakelaar, 1-polig   |
|    | werkschakelaar tbv PV-panelen                               |
|    | schakelaar, 3-polig   |
|    | schakelaar, wissel  |
|    | schakelaar, kruis   |
|    | schakelaar, serie   |
|    | wandcontactdoos 1-voudig met beschermingscontact            |
|    | wandcontactdoos 2-voudig met beschermingscontact, verticaal |
|    | wandcontactdoos 2-voudig met beschermingscontact            |
|    | thermostaatleiding, bedraad                                 |
|  | mechanische ventilatie-unit incl. warmteterugwinunit        |
|  | warmtepomp  |
|  | inblaasventiel mechanische ventilatie                       |
|  | uitblaasventiel mechanische ventilatie                      |
|  | verdeler vloerverwarming                                    |
|  | ruimte voorzien van vloerverwarming                         |
|  | elektrische radiator  |
|  | kanalen in het zicht  |
|  | onbenoemde ruimte volgens krijtstreepmethode                |

### Disclaimer

De op deze tekeningen aangegeven maten zijn circa maten in millimeters en tussen de wanden / vloeren gemeten, waarbij geen rekening is gehouden met enige wandafwerking, plinten, aftimmering, ect. In verband met de nauwkeurige uitwerking van details, constructie, maatvoering, materialen e.d. kunnen er kleine afwijkingen ontstaan ten opzichte van de nu vermelde gegevens. Deze geringe afwijkingen geven geen aanleiding tot verrekening. Aan de op deze tekening aangegeven maten kunnen derhalve geen rechten worden ontleend. De op deze tekeningen aangegeven maatvoering is niet geschikt voor opdrachten aan derden door koper(s). De posities van aansluitingen en installatie onderdelen zijn indicatief op tekening aangegeven. De exacte aantallen en posities zullen na berekening in het werk door de installateurs worden bepaald en kunnen afwijken van deze tekening.

**ALLEMAAL  
YIELEYAAL**

Tekening: Renvooi

Woningtype: -

Bouwnummer: -

Bladnummer: VT-0-00c

Schaal: -

Datum: 27-10-2021



Type: X  
bwnr: 191

Type: X  
bwnr: 190

Type: X  
bwnr: 189

Type: XU  
bwnr: 188



Type: XU  
bwnr: 188

Type: X  
bwnr: 189

Type: X  
bwnr: 190

Type: X  
bwnr: 191

ALLEMAAL  
YIELEYAAL

Tekening: Gevels blok I3

Woningtype: X, X-U

Bouwnummer: 188 t/m 191

Bladnummer: VT-I3-00a

Schaal: 1:150

Datum: 27-10-2021



Type: X  
Bouwnummer: 191

Linker zijgevel

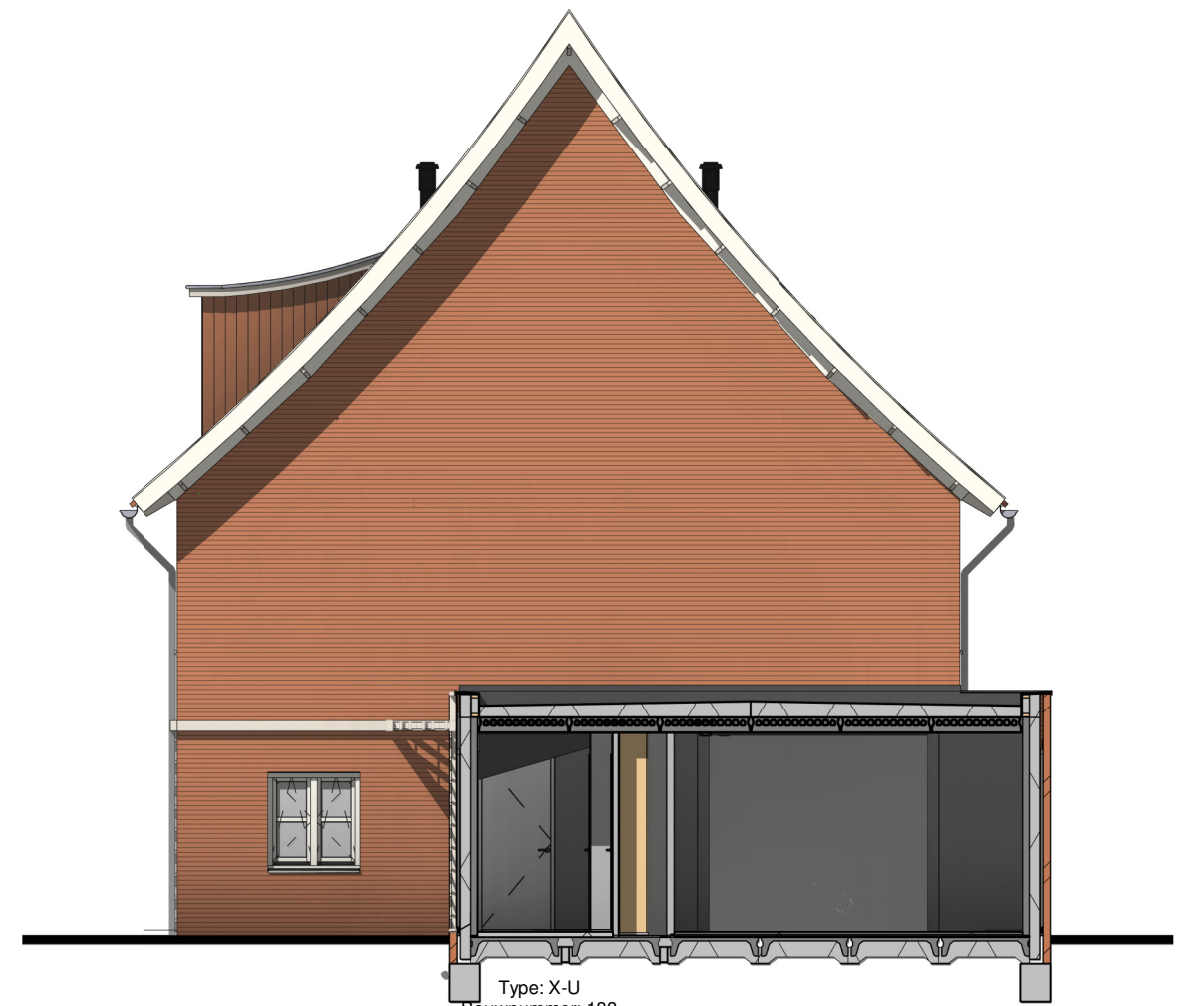

Type: X-U  
Bouwnummer: 188

Rechter zijgevel

ALLEMAAL  
YIELEYAAL

Tekening: Zijgevels blok I3

Woningtype: X, X-U

Bouwnummer: 188 t/m 191

Bladnummer: VT-I3-00b

Schaal: 1:100

Datum: 27-10-2021

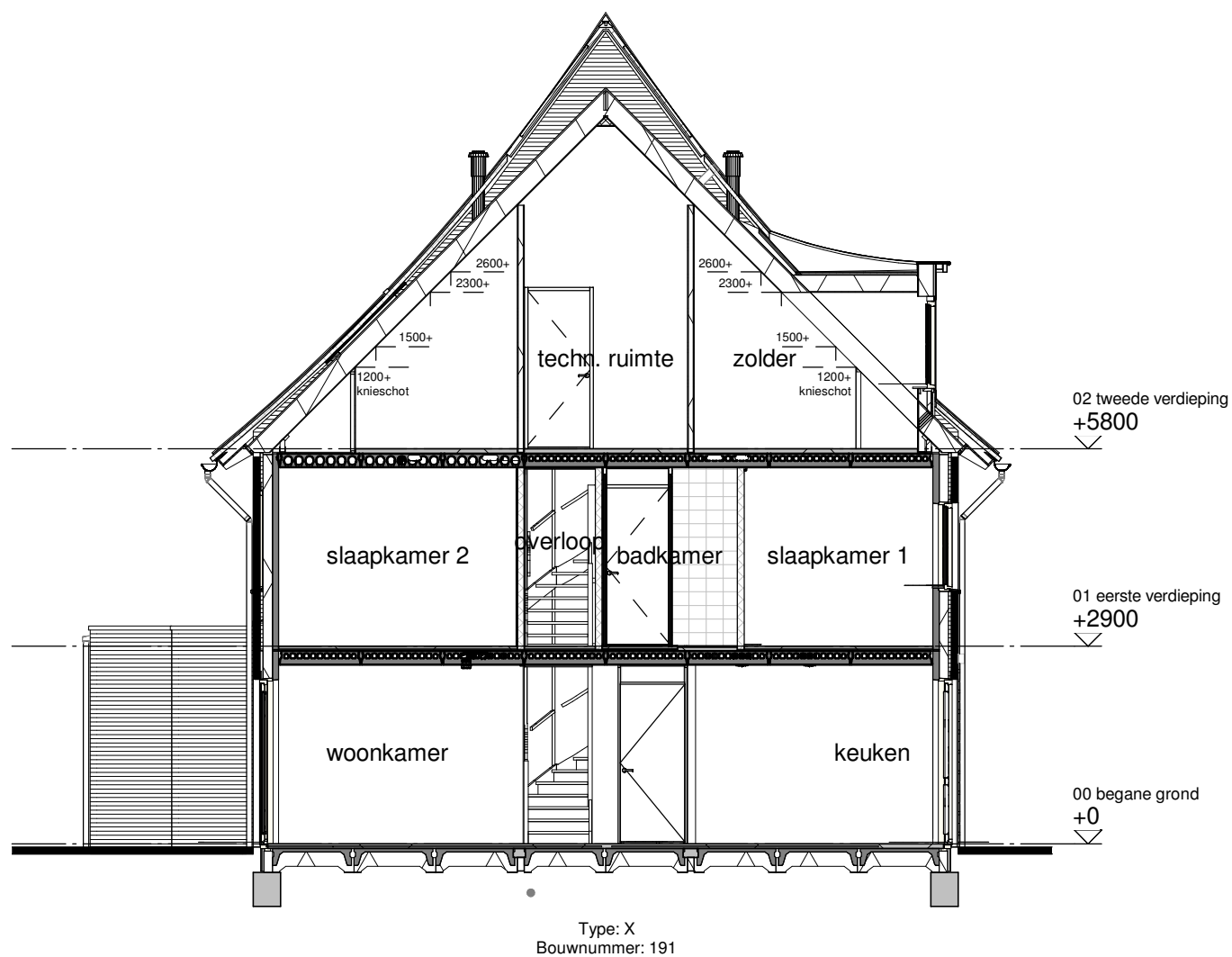

Doorsnede A

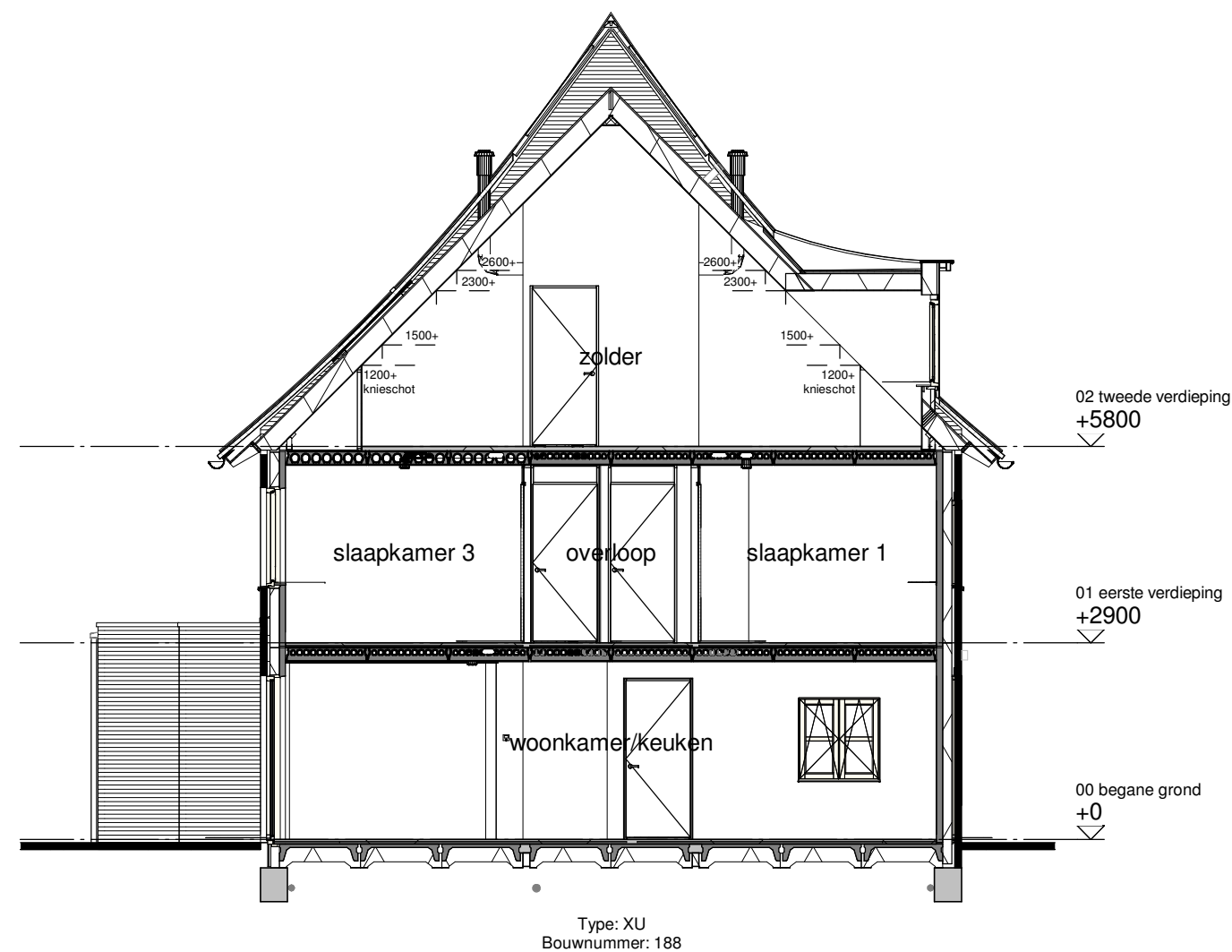

Doorsnede B

**ALLEMAAL  
YIELEYAAL**

Tekening: Doorsnede blok I3

Woningtype: X, XU

Bouwnummer: 188-191

Bladnummer: VT-I3-00c

Schaal: 1:100

Datum: 27-10-2021

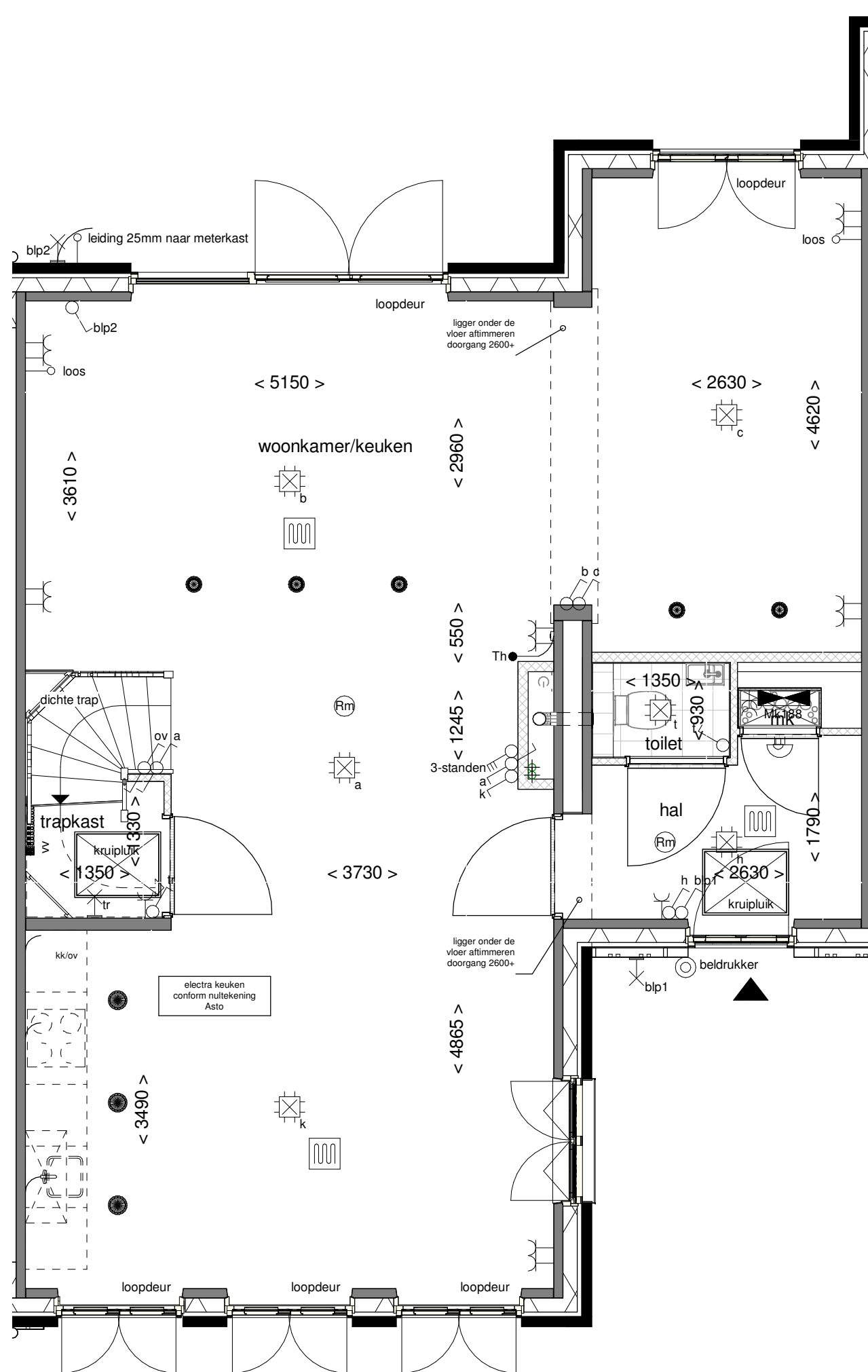

**ALLEMAAL  
VIELEVAAL**

Tekening: Begane grond

Woningtype: XU

Bouwnummer: 188

Bladnummer: VT-13-188a

Schaal: 1:50

Datum: 27-10-2021

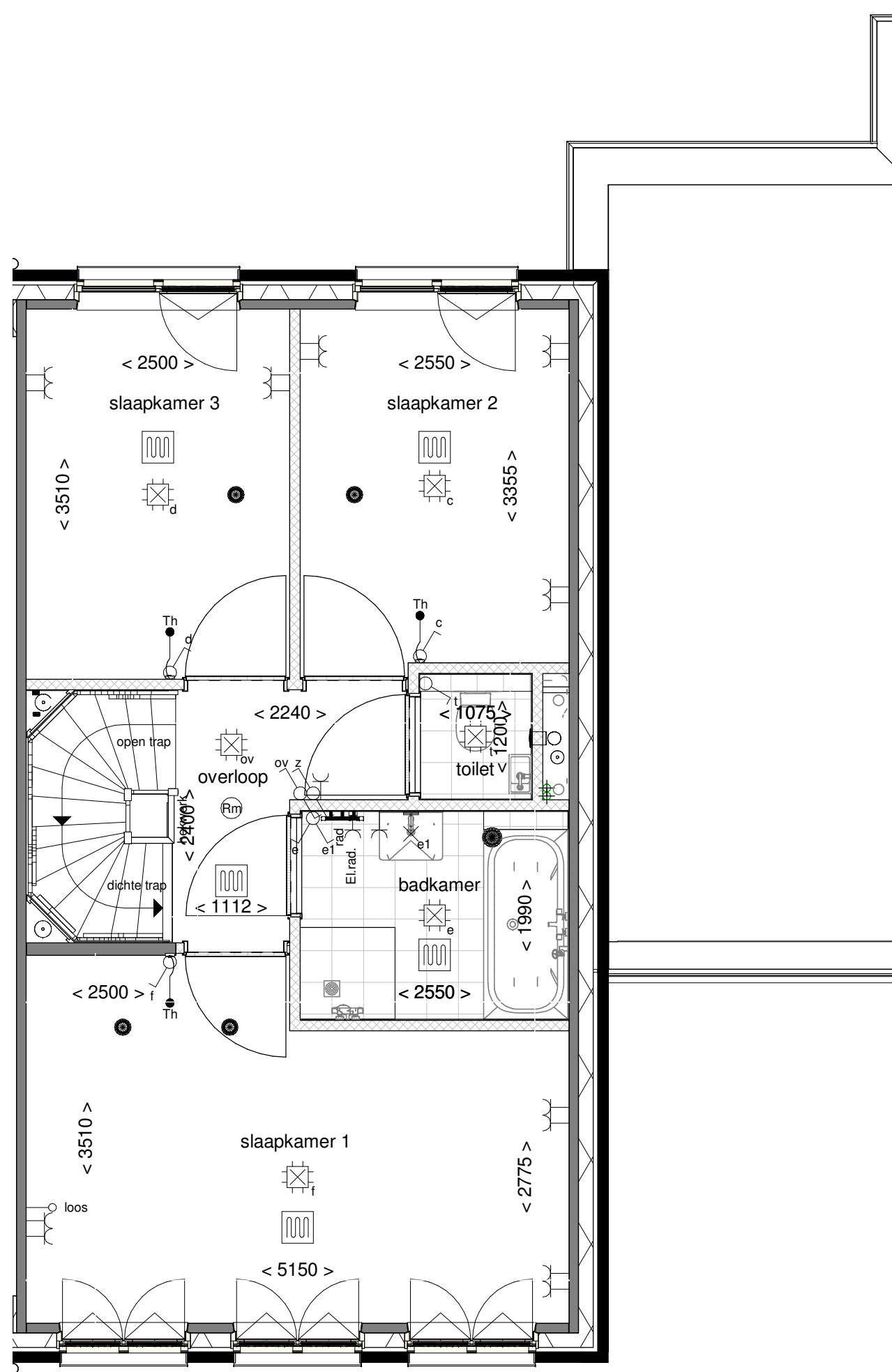

**ALLEMAAL  
VIELEJAAL**

Tekening: Eerste verdieping

Woningtype: XU

Bouwnummer: 188

Bladnummer: VT-13-188b

Schaal: 1:50

Datum: 27-10-2021



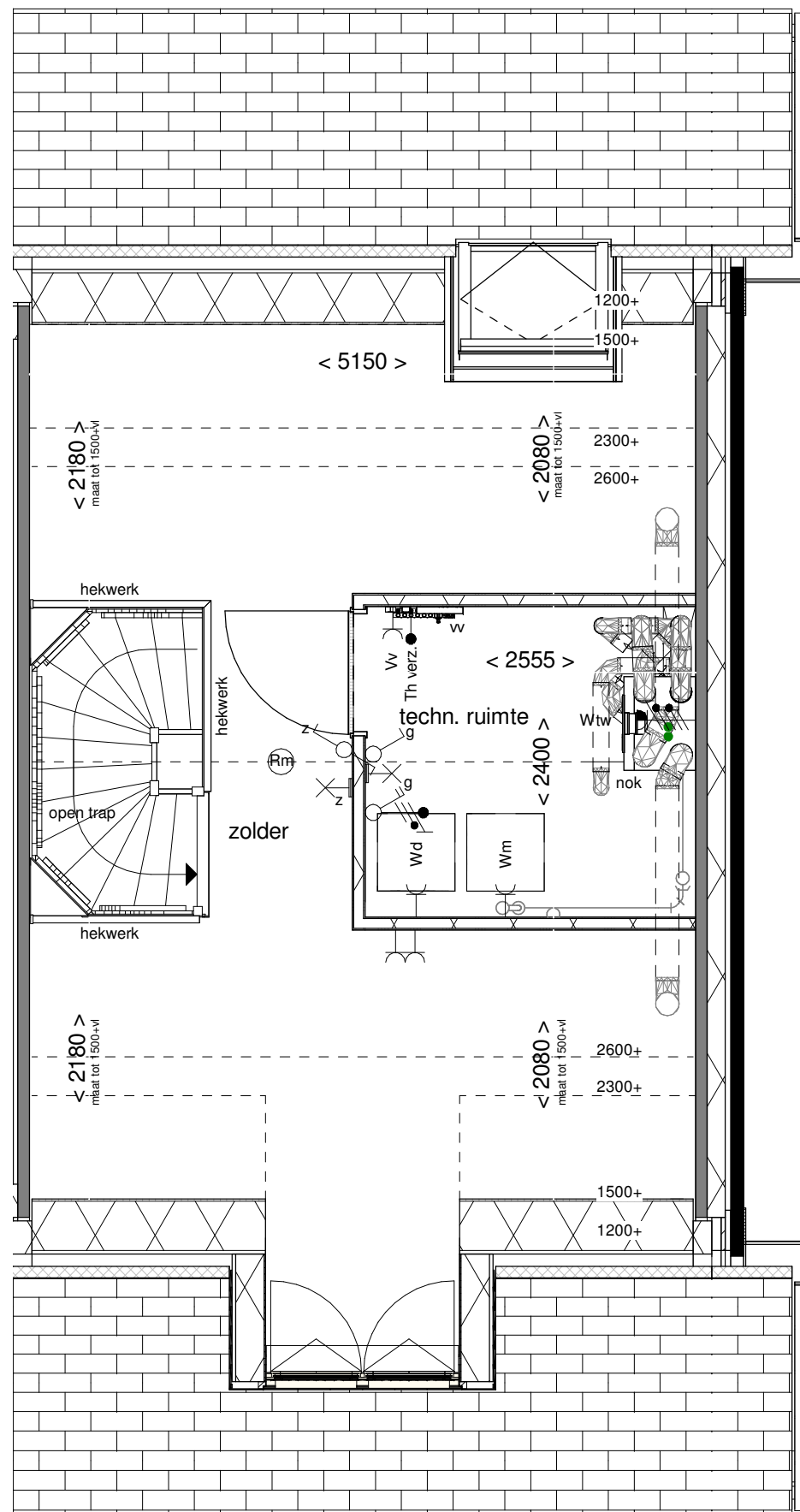

**ALLEMAAL  
YIELEYAAL**

Tekening: Tweede verdieping

Woningtype: XU

Bouwnummer: 188

Bladnummer: VT-13-188c

Schaal: 1:50

Datum: 27-10-2021

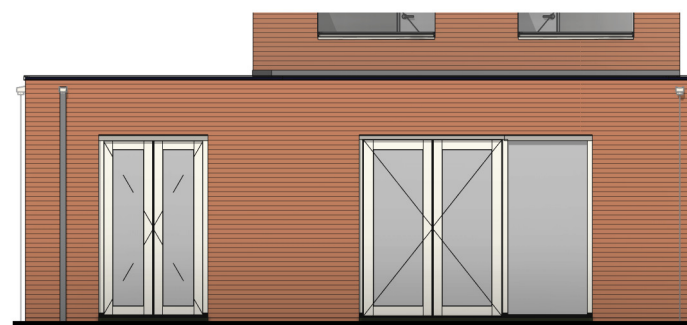
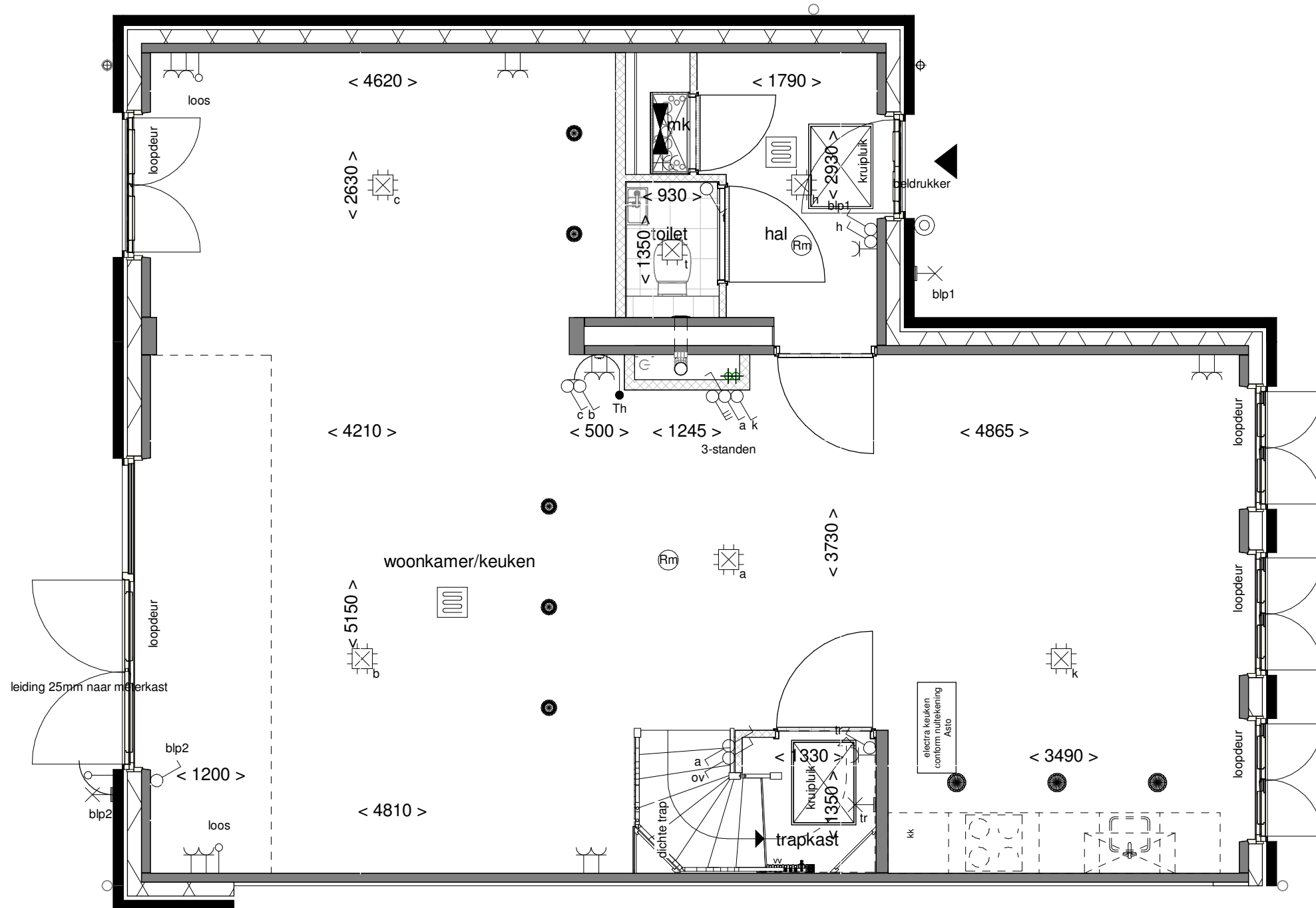

Achtergevel schaal 1:100

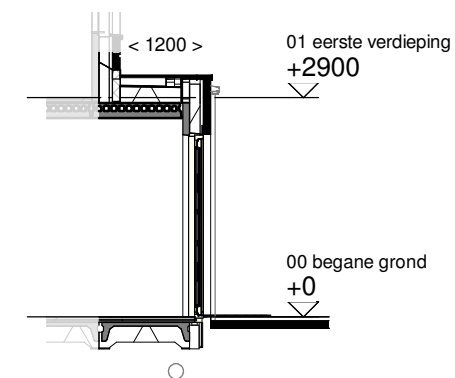

Doorsnede schaal 1:100

**ALLEMAAL  
YIELEYAAL**

Optie: **Uitbouw achtergevel  
1200mm**

Woningtype: **X54U**

Bouwnummer: -

Optienummer: **1.A.X.12**

Schaal: **1:50 / 1:100**

Datum: **29-09-2021**

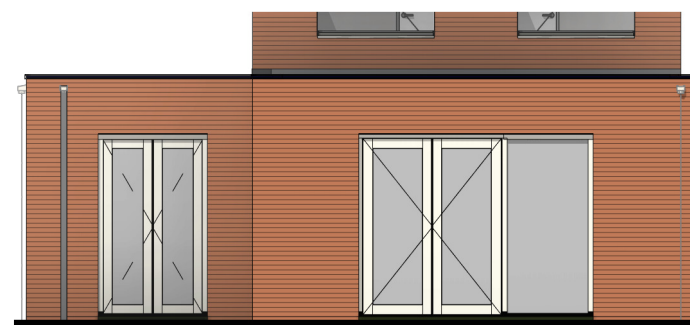
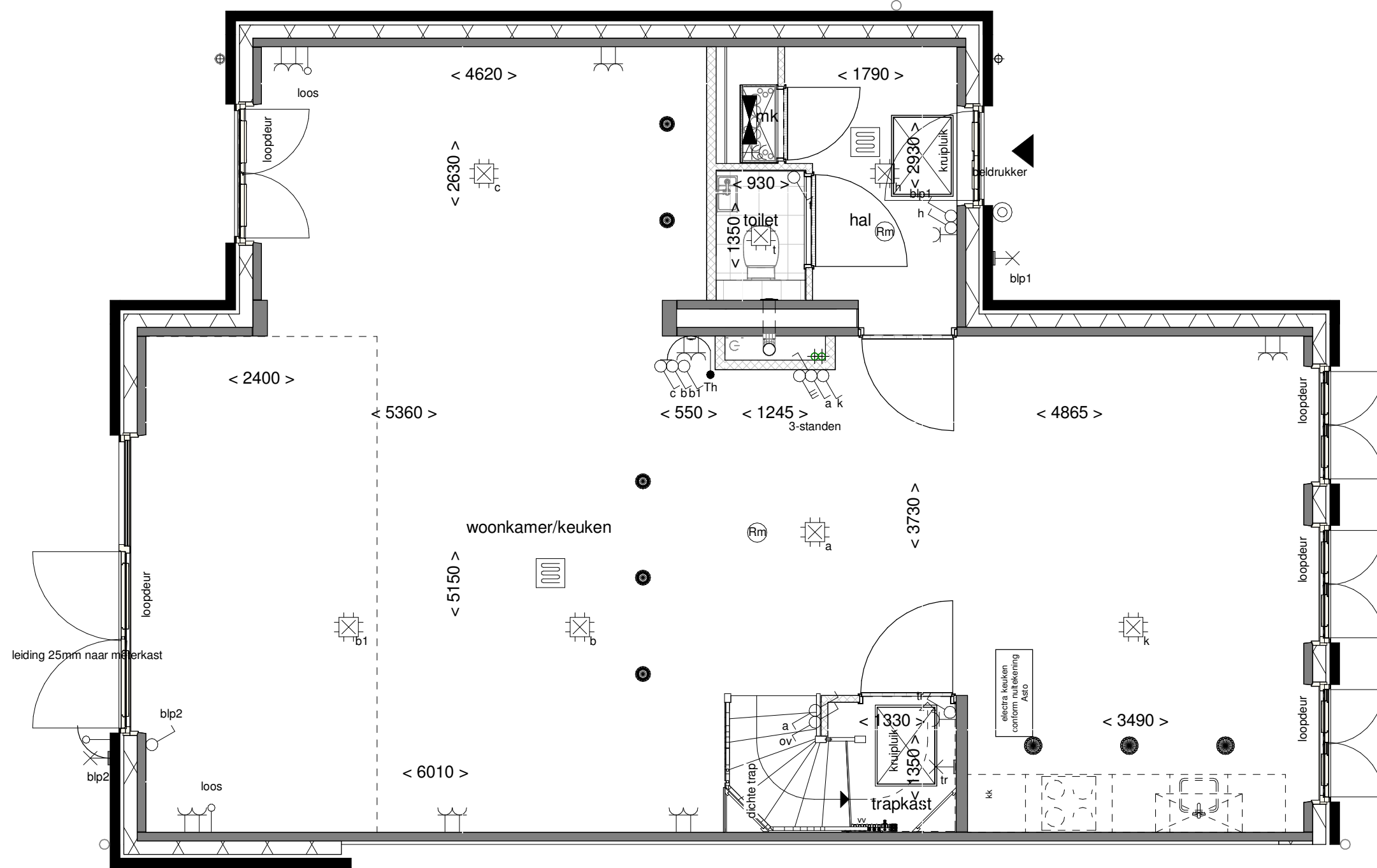

Achtergevel schaal 1:100

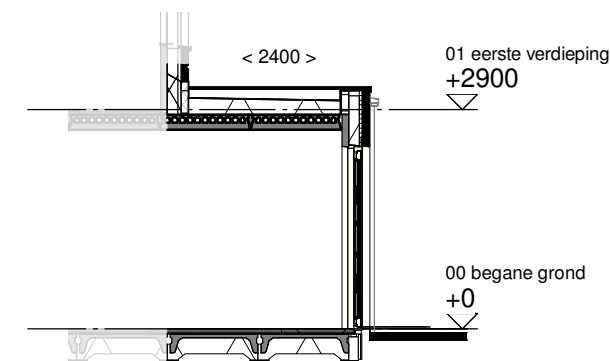

Doorsnede schaal 1:100

**ALLEMAAL  
VIELEJAAR**

Optie: **Uitbouw achtergevel  
2400mm**

Woningtype: **X54U**

Bouwnummer: **-**

Optienummer: **1.A.X.32**

Schaal: **1:50 / 1:100**

Datum: **29-09-2021**

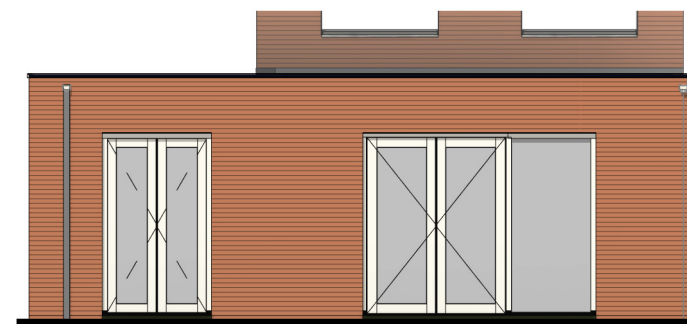
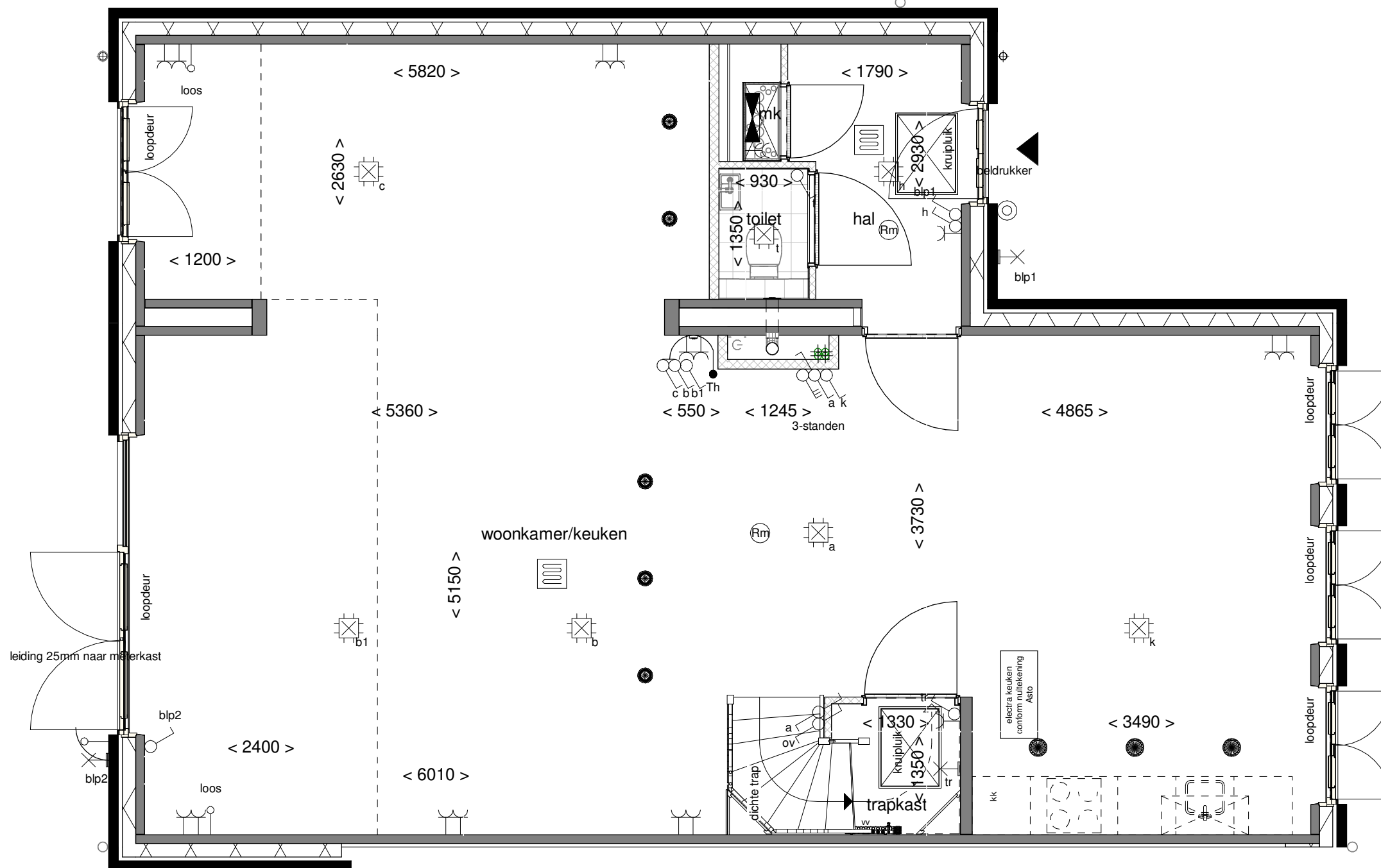

Achtergevel schaal 1:100

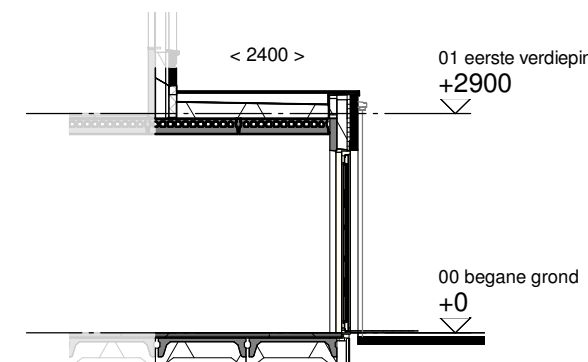

Doorsnede schaal 1:100

**ALLEMAAL  
YIELEYAAL**

Optie: Uitb. achter 2400mm  
+ zijuitbouw 1200mm

Woningtype: X54U

Bouwnummer: -

Optienummer: 1.A.X.52B

Schaal: 1:50 / 1:100

Datum: 29-09-2021

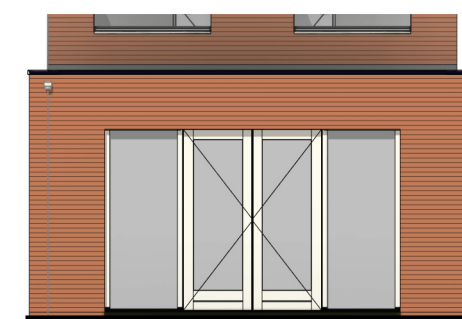
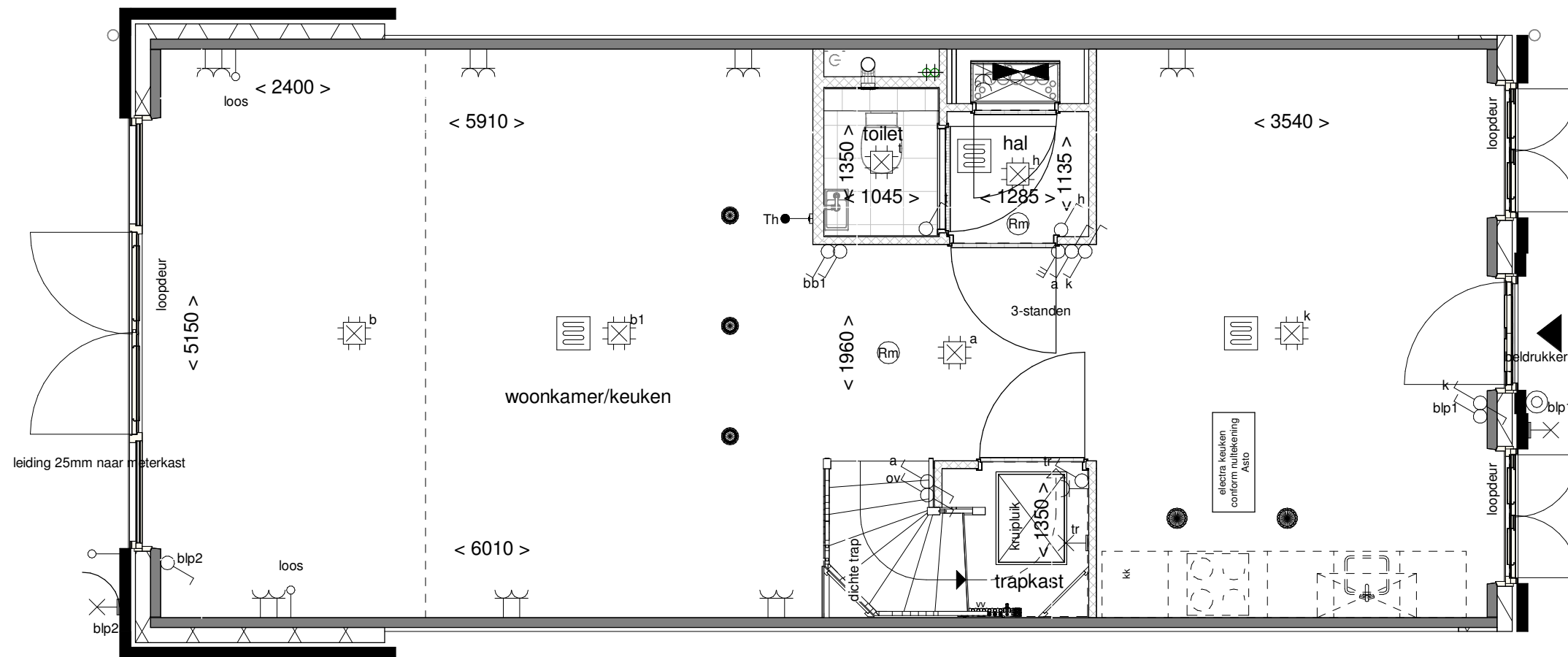

Achtergevel schaal 1:100

**ALLEMAAL  
VIELEJAAL**

Optie: Dubbele deuren  
achtergevel 3900mm

Woningtype: X54

Bouwnummer: -

Optienummer: 1.A.X.62

Schaal: 1:50 / 1:100

Datum: 29-09-2021

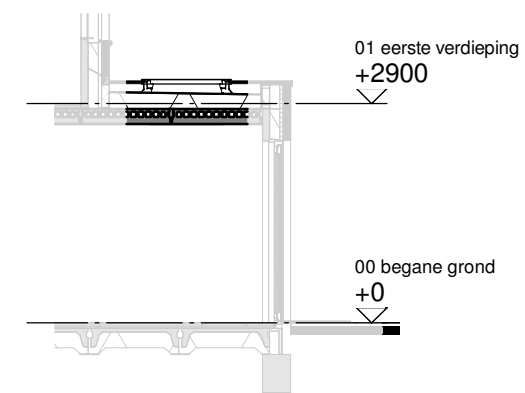
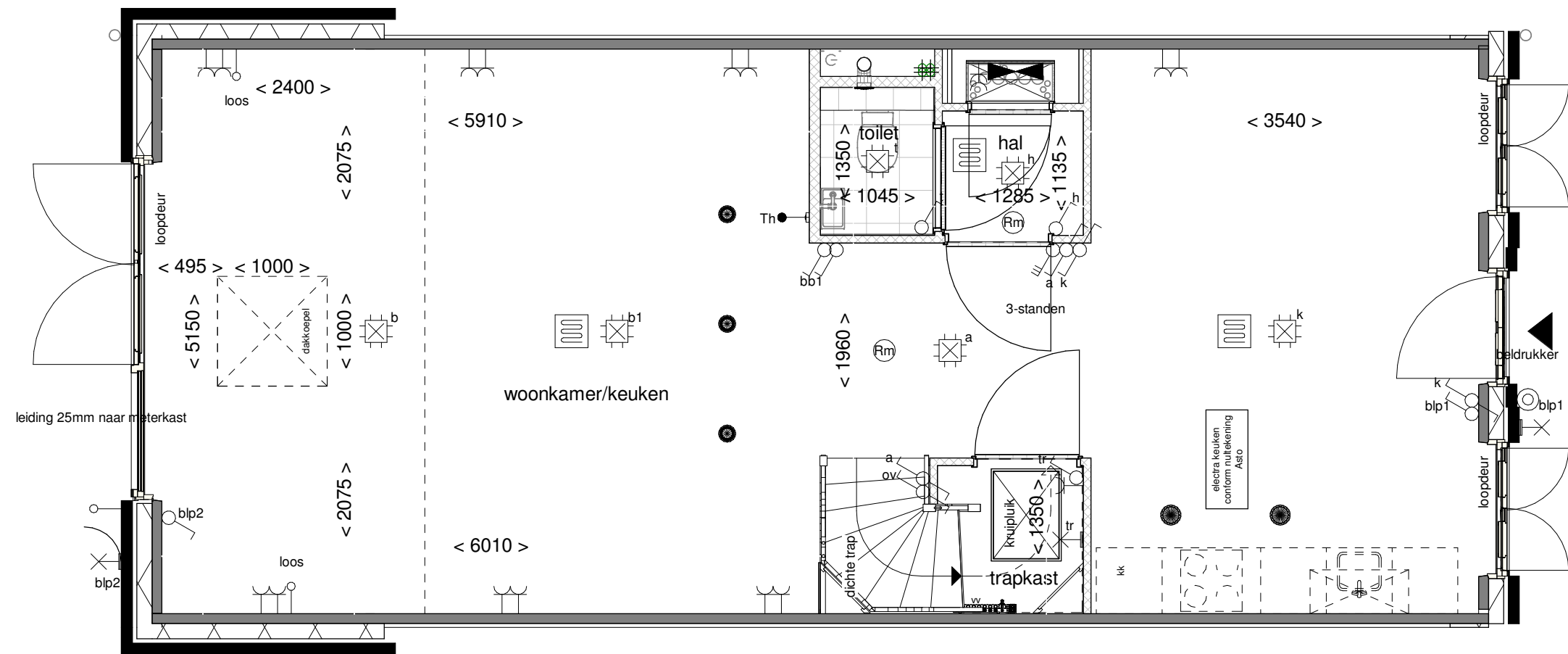

Doorsnede schaal 1:100

**ALLEMAAL  
YIELEYAAL**

Optie: Lichtkoepel in  
uitbouw 2400mm

Woningtype: X54

Bouwnummer: -

Optienummer: 1.B.X.10

Schaal: 1:50 / 1:100

Datum: 29-09-2021

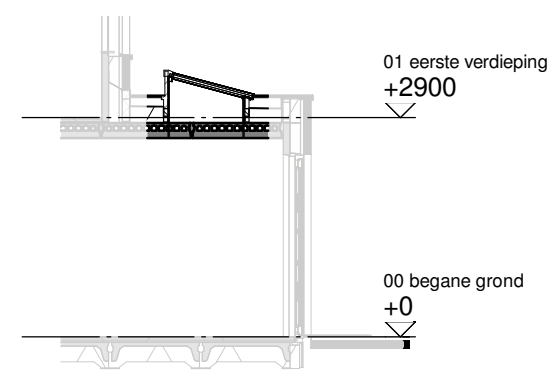
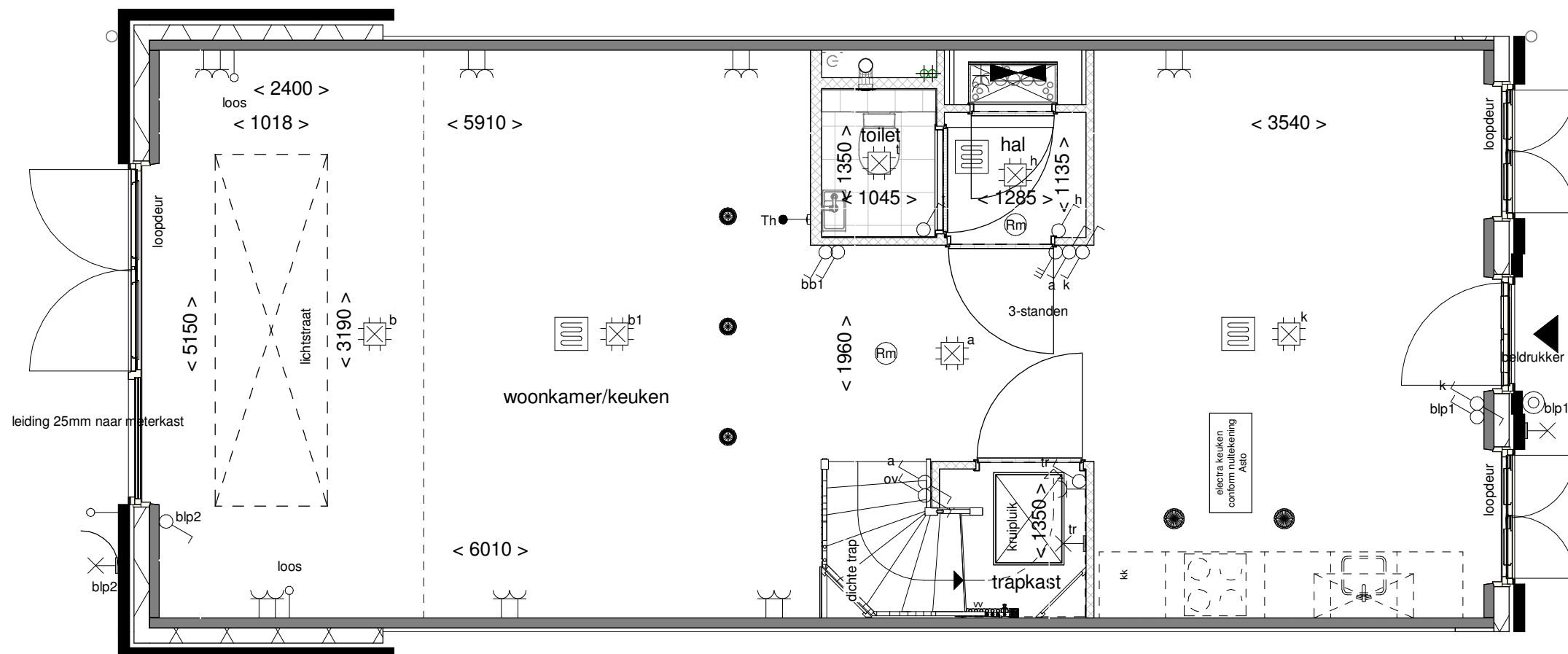

Doorsnede schaal 1:100

**ALLEMAAL  
YIELEYAAL**

Optie: Lichtstraat in uitbouw  
2400mm

Woningtype: X54

Bouwnummer: -

Optienummer: 1.B.X.14

Schaal: 1:50 / 1:100

Datum: 29-09-2021

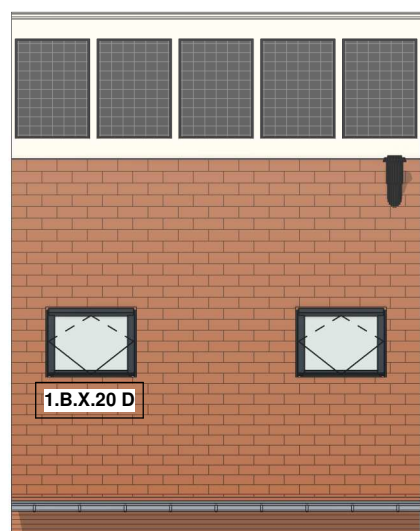
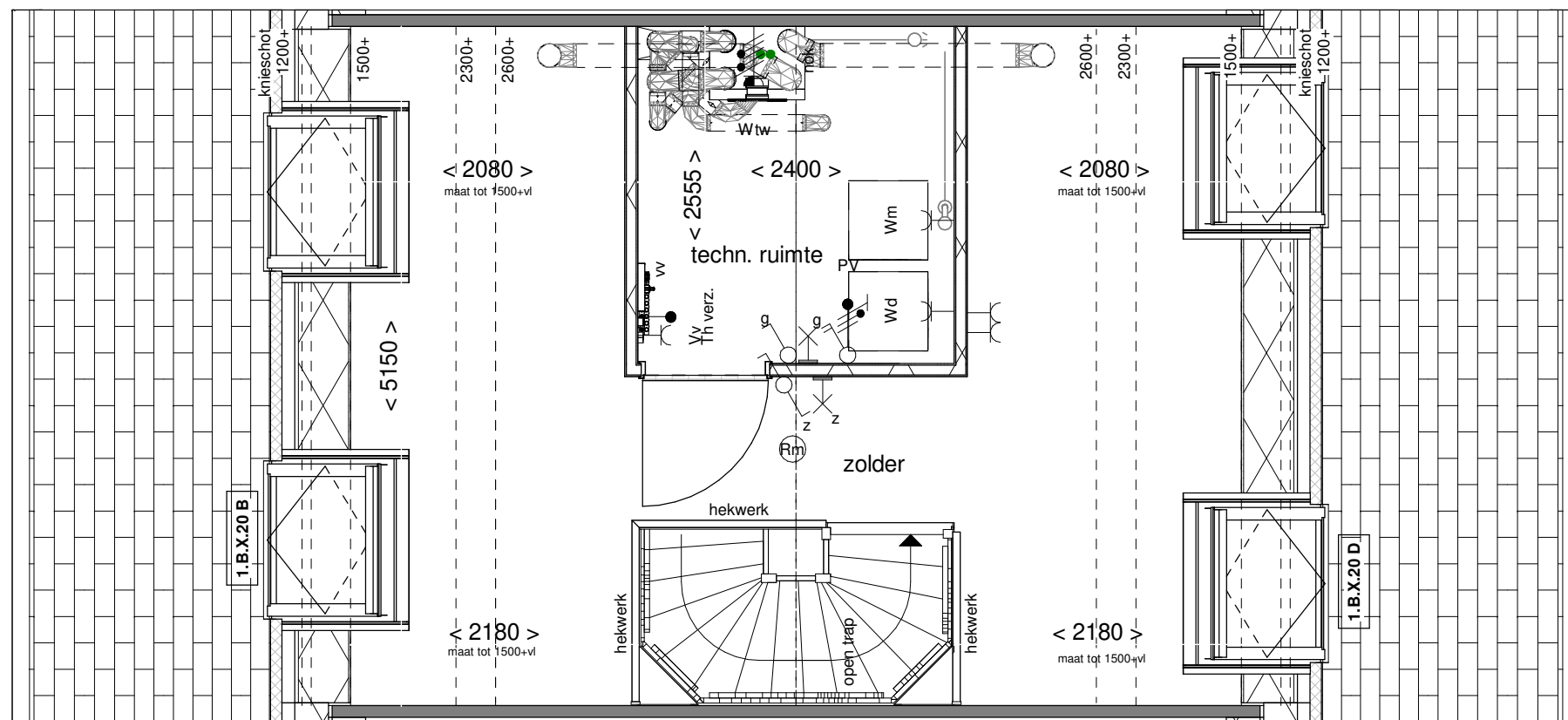

Voorgevel schaal 1:100

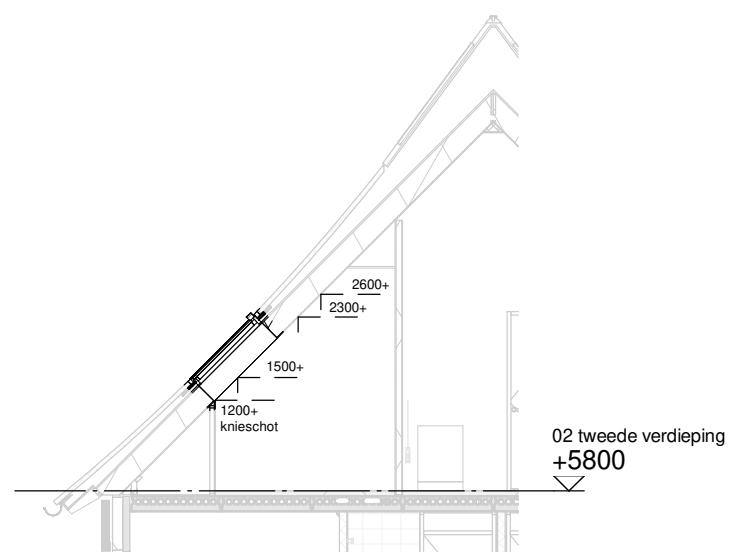

Doorsnede schaal 1:100

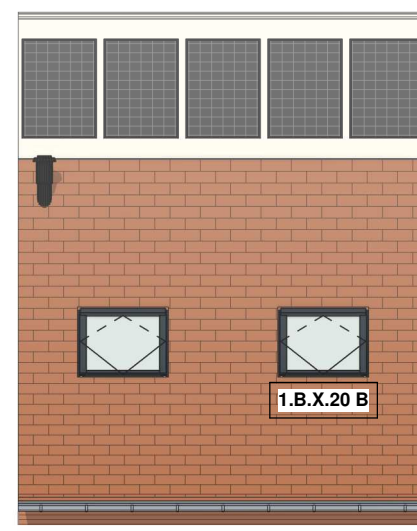

Achtergevel schaal 1:100

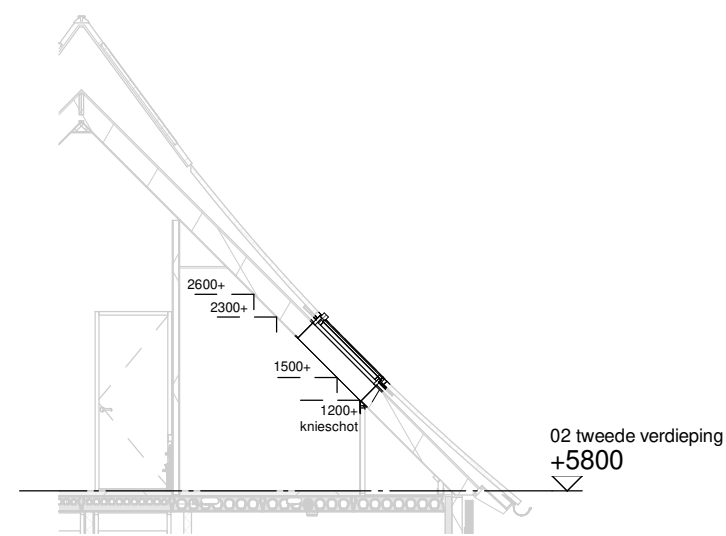

Doorsnede schaal 1:100

**ALLEMAAL  
VIELEJAAL**

Optie: Dakramen voor- en achtergevel

Woningtype: X54

Bouwnummer: -

Optienummer: 1.B.X.20

Schaal: 1:50 / 1:100

Datum: 29-09-2021



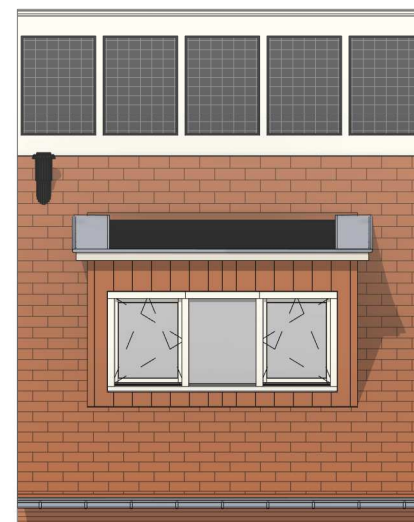
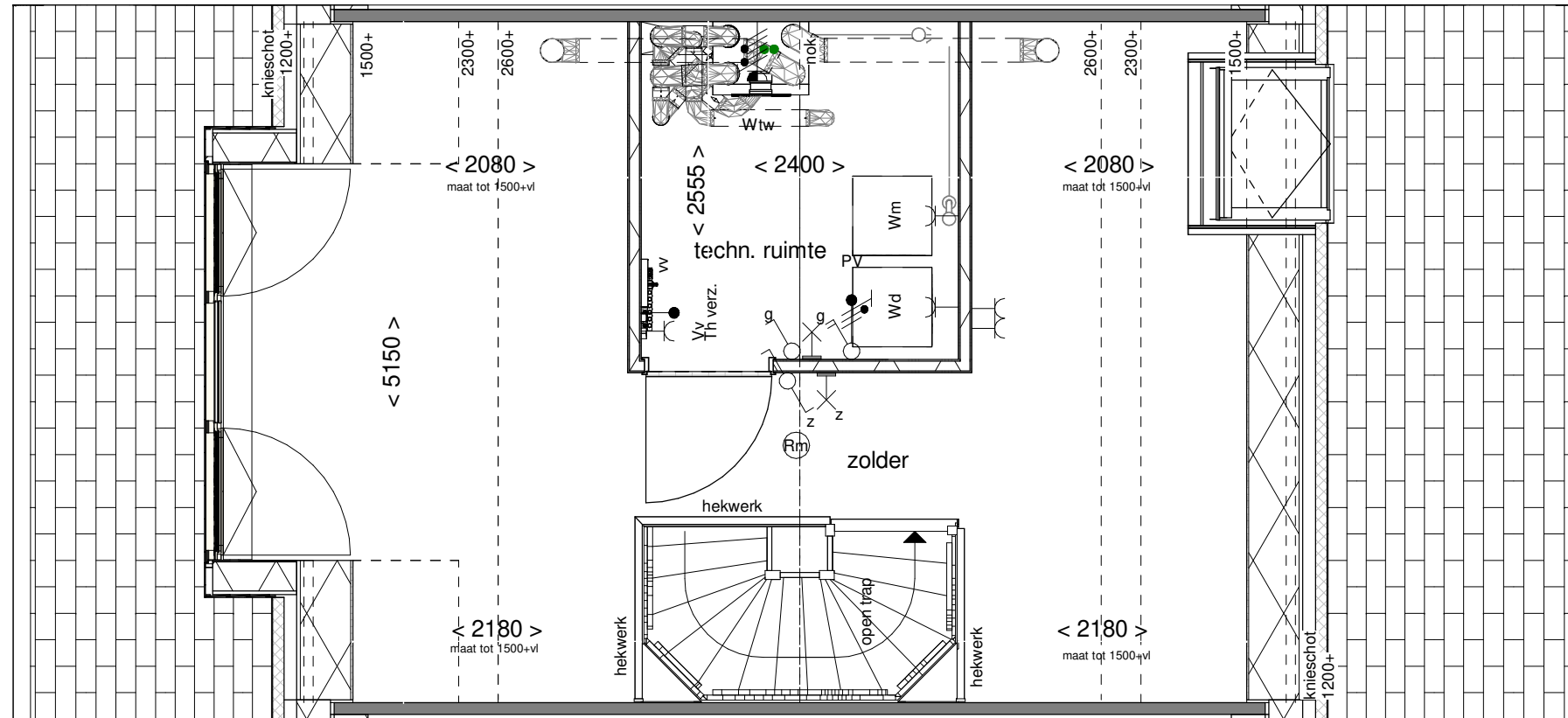

Achtergevel schaal 1:100

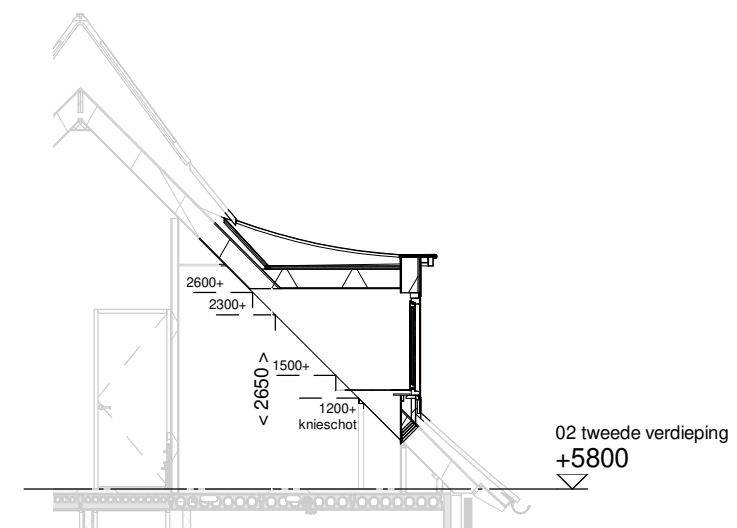

Doorsnede schaal 1:100

**ALLEMAAL  
YIELEYAAL**

Optie: Dakkapel  
achtergevel 3000mm

Woningtype: X54

Bouwnummer: -

Optienummer: 1.B.X.34

Schaal: 1:50 / 1:100

Datum: 29-09-2021

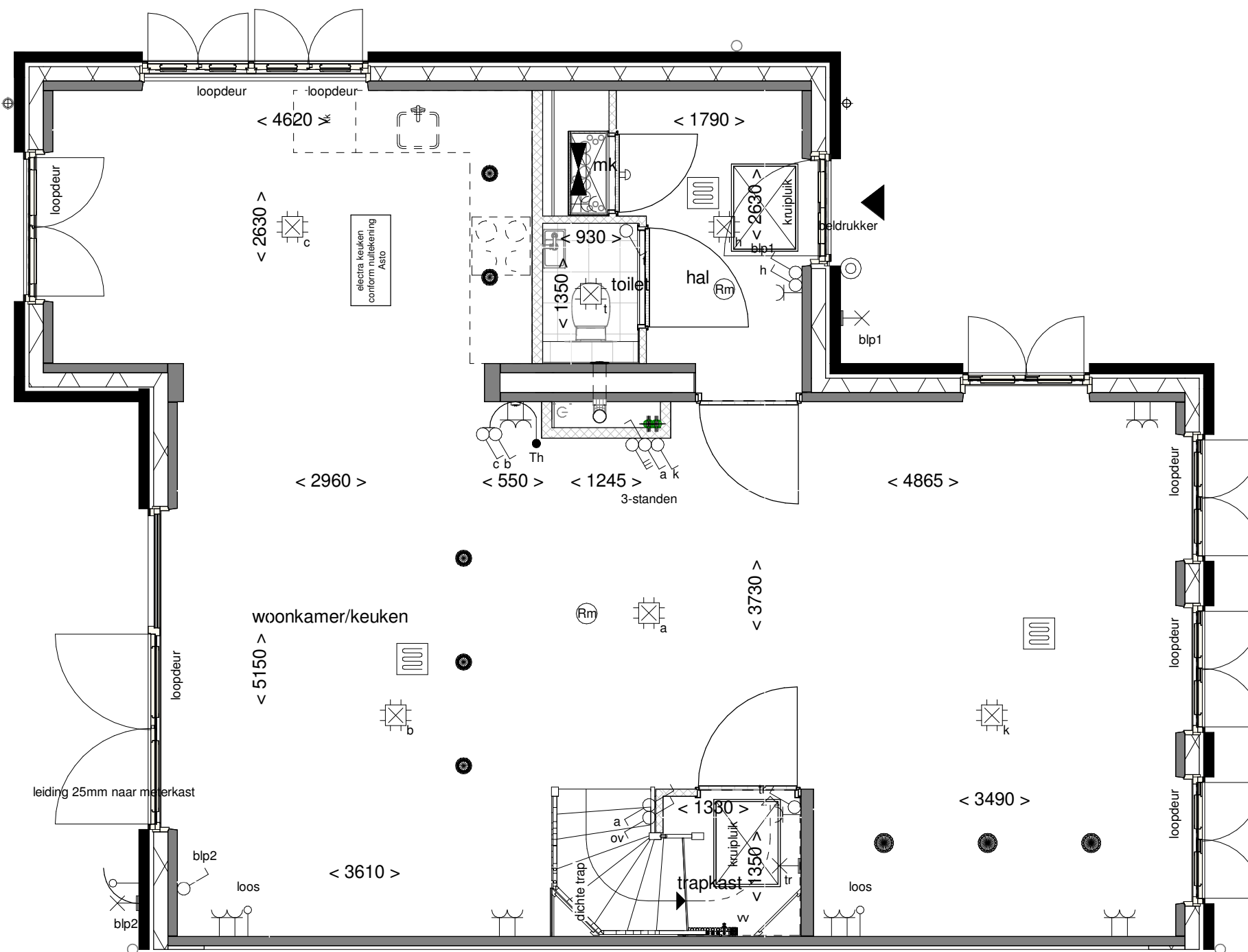

**ALLEMAAL  
VIELEYAAL**

Optie: Keuken in zij-uitbouw

Woningtype: X54U

Bouwnummer: -

Optienummer: 1.C.X.12

Schaal: 1:50

Datum: 29-09-2021

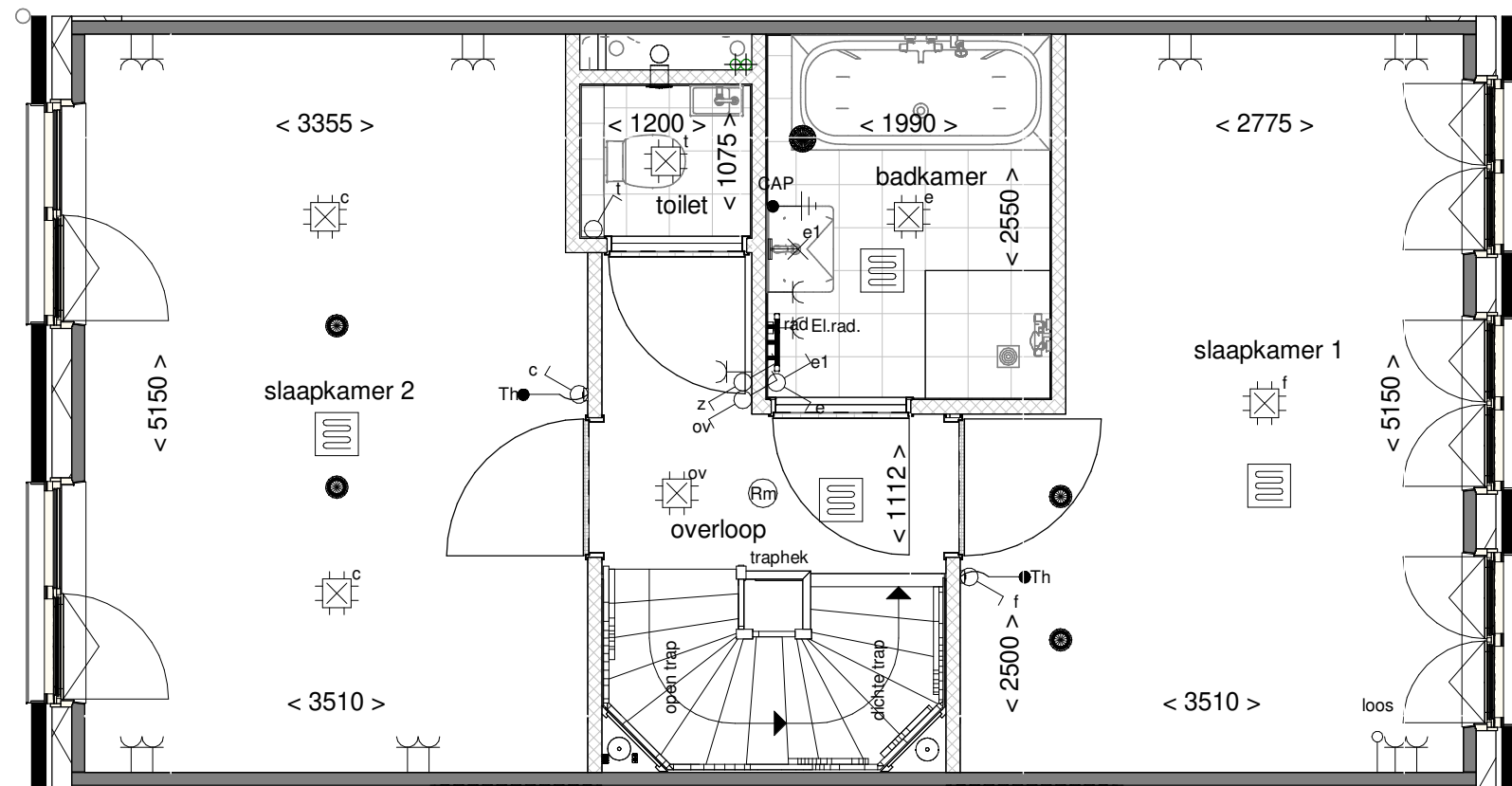

**ALLEMAAL  
VIELEJAAR**

Optie: Samenvoegen  
slaapkamer 2 en 3

Woningtype: X54

Bouwnummer: -

Optienummer: 1.C.X.30

Schaal: 1:50

Datum: 29-09-2021

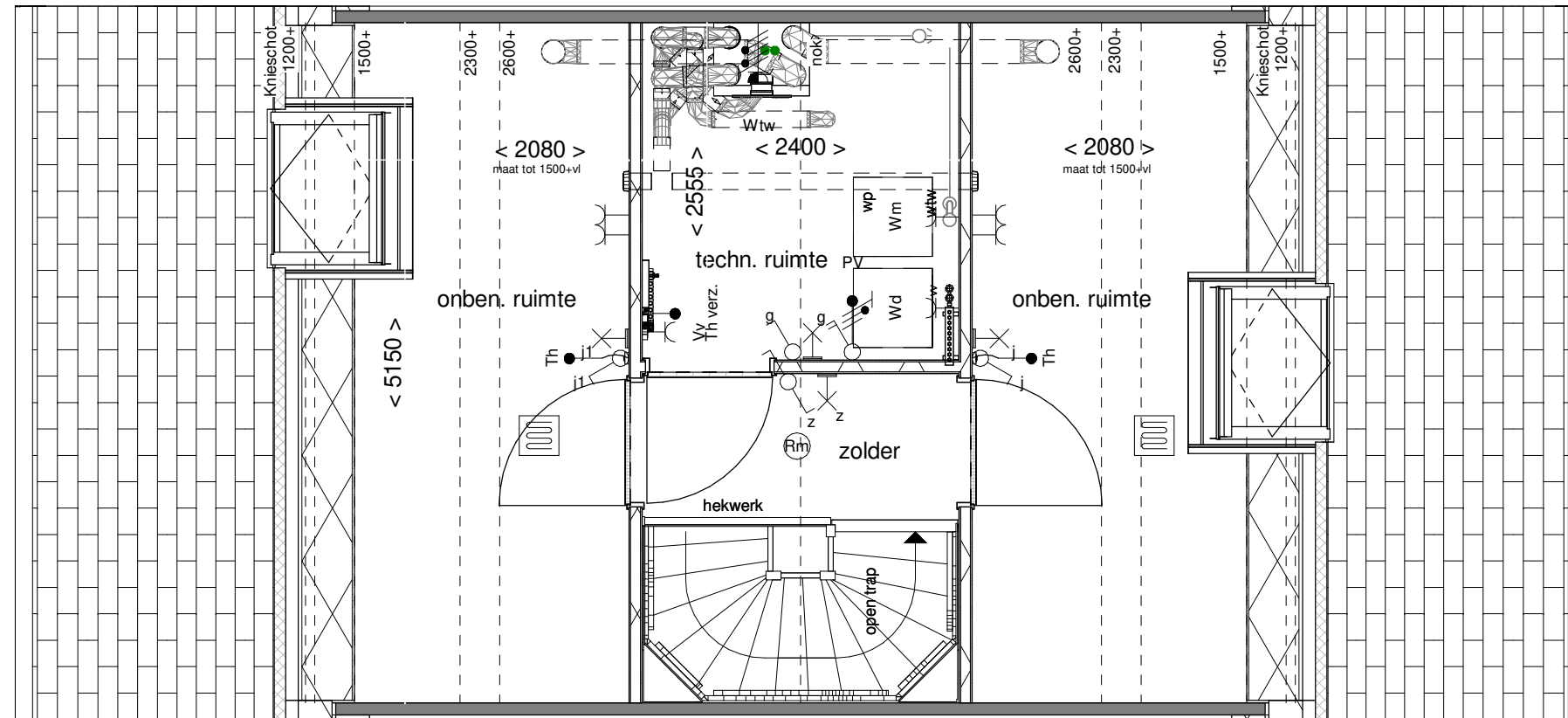

**ALLEMAAL  
YIELEYAAL**

Optie: Indeling techn.- en 2  
onb. ruimtes

Woningtype: X54

Bouwnummer: -

Optienummer: 1.C.X.76

Schaal: 1:50

Datum: 29-09-2021

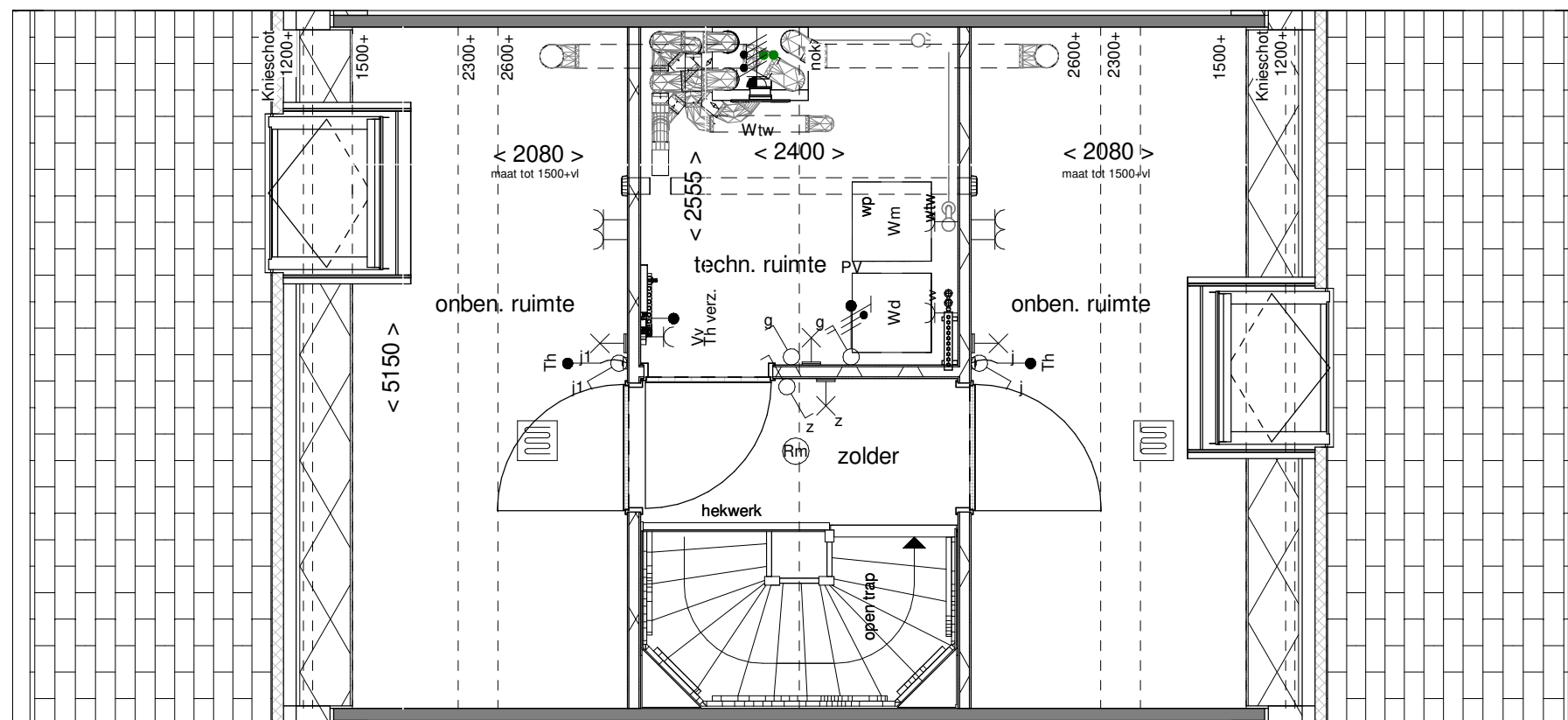

**ALLEMAAL  
VIELEJAAL**

Optie: Indeling techn.- en 2  
onb. ruimtes

Woningtype: X54

Bouwnummer: -

Optienummer: 1.C.X.78

Schaal: 1:50

Datum: 29-09-2021