

**ALLEMAAL  
YIELEYAAL**

Tekening: **Situatie totaal**

Woningtype:











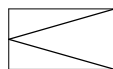

Bouwnummer:

Bladnummer: **VT-S-01**

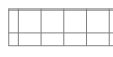
Schaal: **1:1000**

Datum: **29-09-2021**

## Renvooi

-  - entree woning
-  - parkeervak eigen terrein
-  - erfgrans
-  - beplanting type n.t.b. koper
-  - opstelplaats kliko
-  - tuinhekje
-  - klinkerbestrating
-  - betontegels 300x300mm
-  - groen strook
-  - haag h=900mm
-  - haag h=1800mm
-  - bamboehek h=1800mm
-  - gaashek met klimplanten en poort h=1600mm

parkeerplekken en posities bomen en struiken zijn indicatief

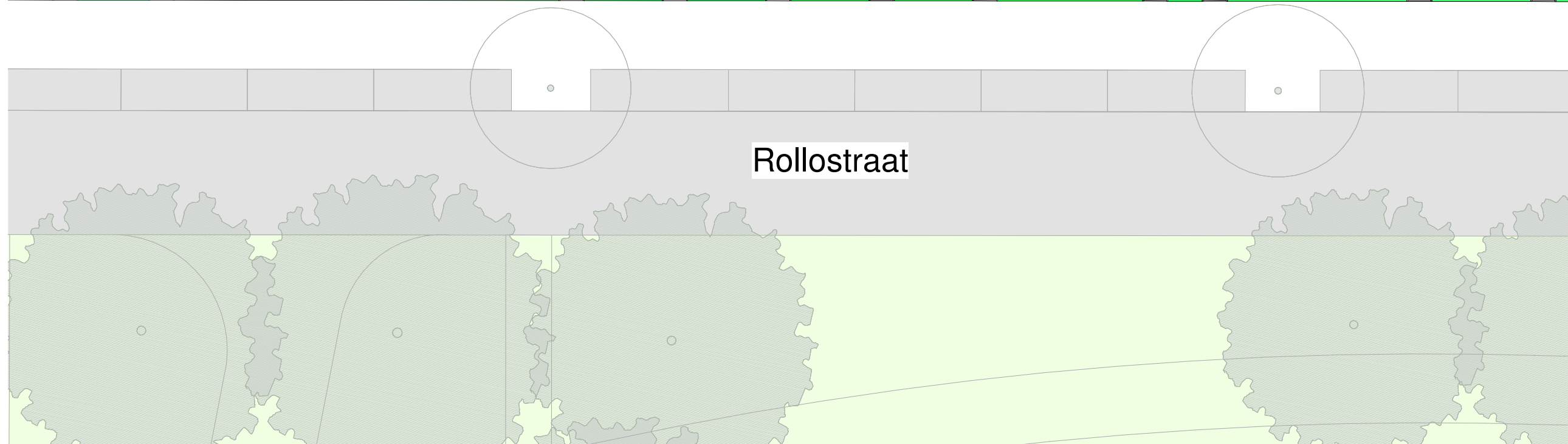
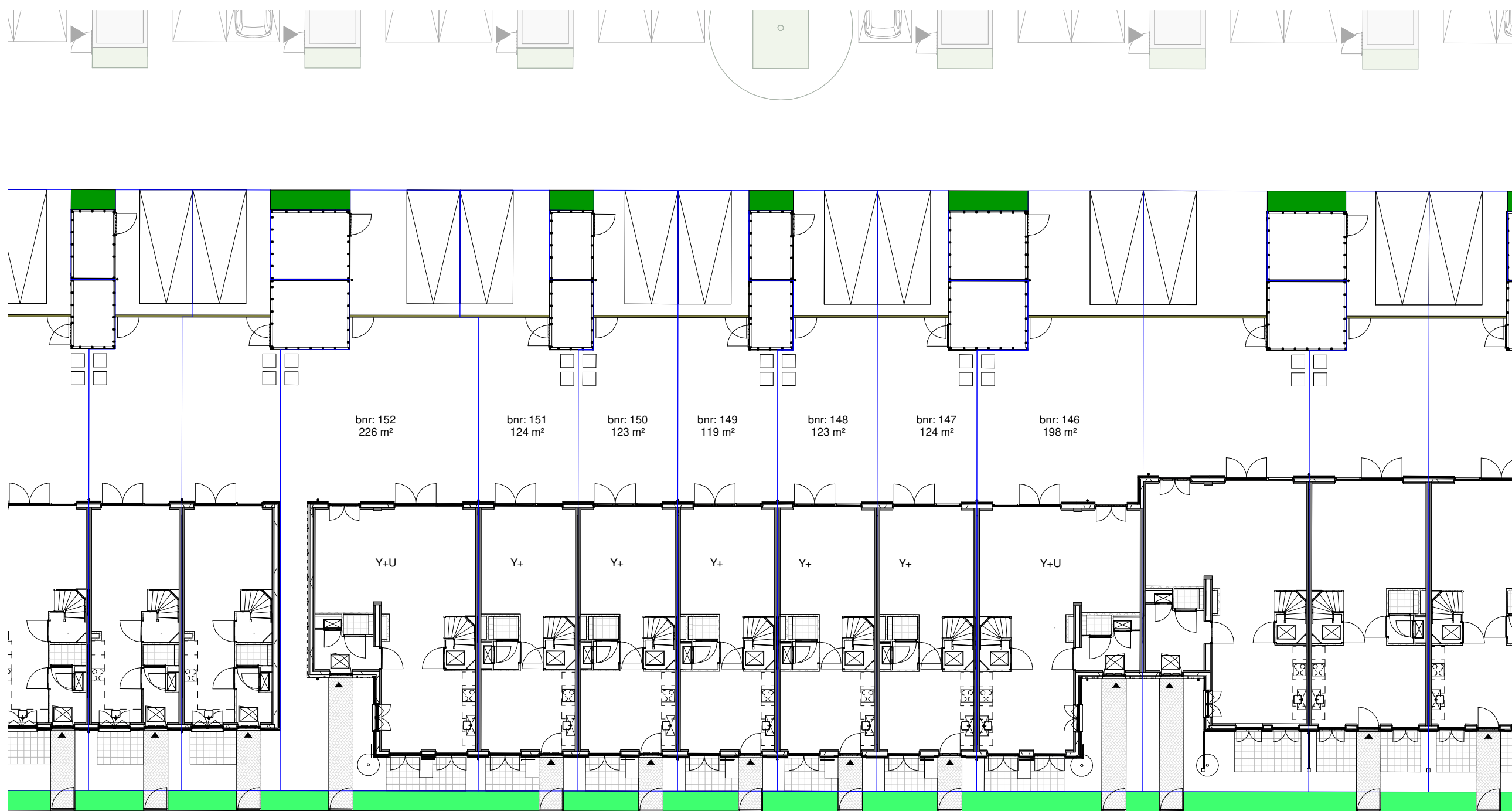

**ALLEMAAL  
YIELEYAAL**

Tekening: Situatie Blok H2

Woningtype: Y+U, Y+

Bouwnummer: 146-152











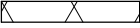

Bladnummer: VT-S-07

Schaal: 1:200



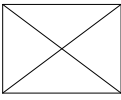

























Datum: 29-09-2021



## Renvooi bouwkundig

	metselwerk kleur A
	dakpannen kleur oranje
	entree woning
	metselwerk
	isolatie
	dragende wand
	niet dragende binnenwand
	binnendeurkozijn (met bovenlicht)
	kruipluik
	opstelplaats wasmachine
	opstelplaats wasdroger
	
	principe opstelling keukenblok

## Renvooi installaties

	aansluitpunt licht
	aansluitpunt licht, wand
	centraaldoos met lichtpunt
	armatuur aan de wand
	rookmelder
	aansluitpunt niet bedraad
	verdeelinrichting / meterkast / groepenkast
	beldrukker
	schel
	schakelaar, 1-polig
	werkschakelaar tbv PV-panelen
	schakelaar, 3-polig
	schakelaar, wissel
	schakelaar, kruis
	schakelaar, serie
	wandcontactdoos 1-voudig met beschermingscontact
	wandcontactdoos 2-voudig met beschermingscontact, verticaal
	wandcontactdoos 2-voudig met beschermingscontact
	thermostaatleiding, bedraad
	mechanische ventilatie-unit incl. warmteterugwinunit
	warmtepomp
	inblaasventiel mechanische ventilatie
	uitblaasventiel mechanische ventilatie
	verdeler vloerverwarming
	ruimte voorzien van vloerverwarming
	elektrische radiator
	kanalen in het zicht
	onbenoemde ruimte volgens krijstreepmethode

### Disclaimer

De op deze tekeningen aangegeven maten zijn circa maten in millimeters en tussen de wanden / vloeren gemeten, waarbij geen rekening is gehouden met enige wandafwerking, plinten, aftimmering, ect. In verband met de nauwkeurige uitwerking van details, constructie, maatvoering, materialen e.d. kunnen er kleine afwijkingen ontstaan ten opzichte van de nu vermelde gegevens. Deze geringe afwijkingen geven geen aanleiding tot verrekening. Aan de op deze tekening aangegeven maten kunnen derhalve geen rechten worden ontleend. De op deze tekeningen aangegeven maatvoering is niet geschikt voor opdrachten aan derden door koper(s). De posities van aansluitingen en installatie onderdelen zijn indicatief op tekening aangegeven. De exacte aantallen en posities zullen na berekening in het werk door de installateurs worden bepaald en kunnen afwijken van deze tekening.

**ALLEMAAL  
YIELEYAAL**

Tekening: Renvooi

Woningtype: -

Bouwnummer: -

Bladnummer: VT-0-00c

Schaal: -

Datum: 29-09-2021



Voorgevel

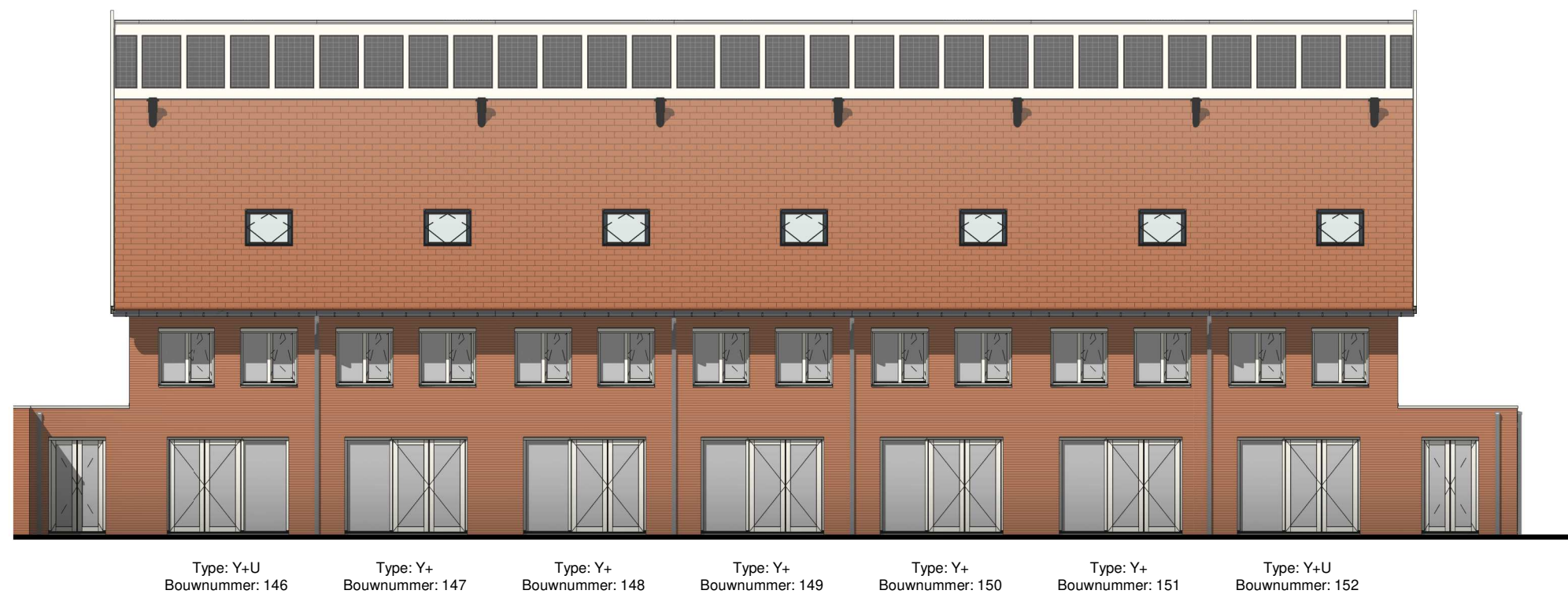

Achtergevel

ALLEMAAL  
YIELEYAAL

Tekening: Gevels blok H2

Woningtype: Y+, Y+U

Bouwnummer: 146 t/m 152

Bladnummer: VT-H2-00a

Schaal: 1:150

Datum: 29-09-2021



Type: Y+U  
Bouwnummer: 152

Linker zijgevel

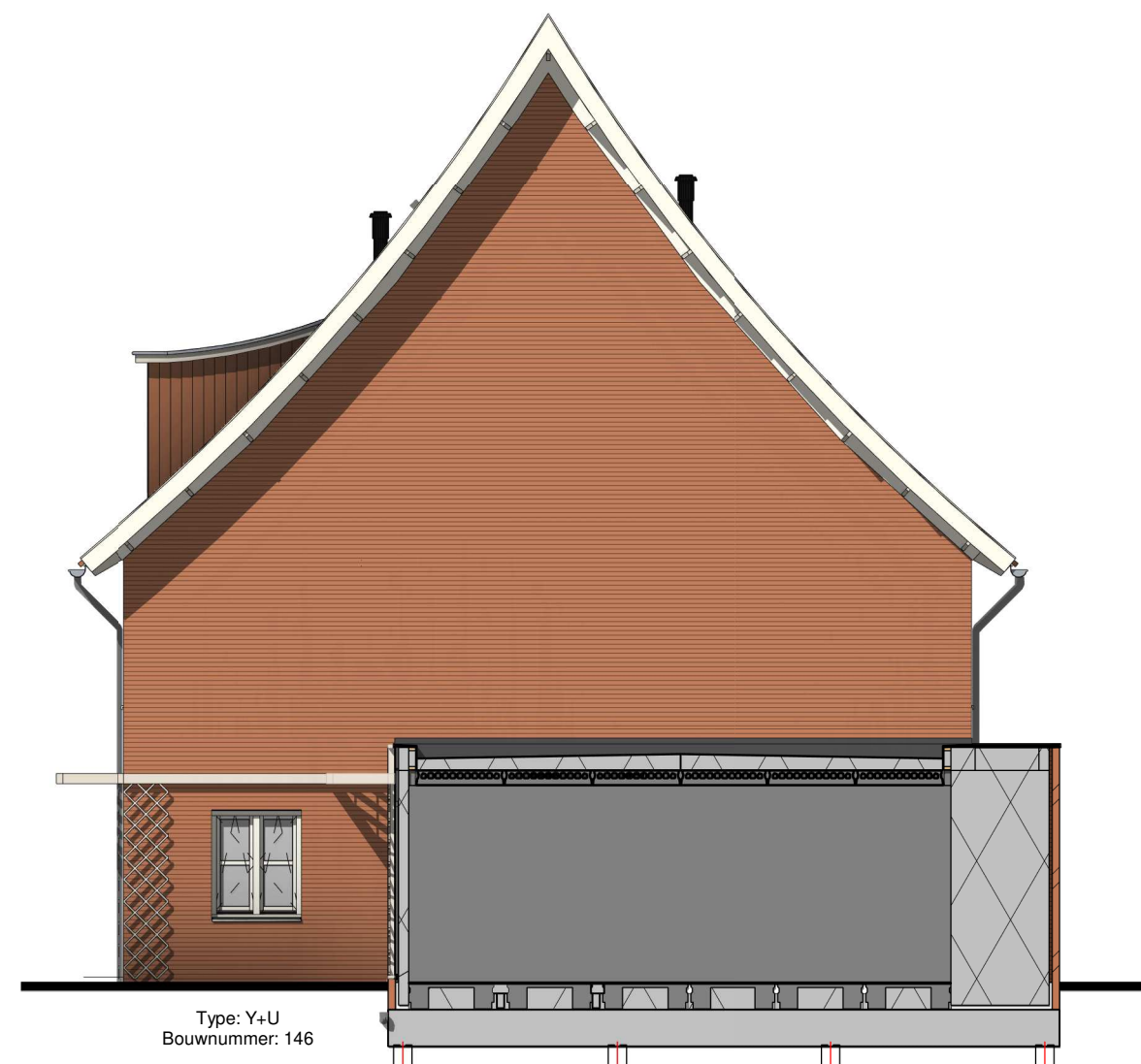

Type: Y+U  
Bouwnummer: 146

Rechter zijgevel

ALLEMAAL  
YIELEYAAL

Tekening: Zijgevels blok H2

Woningtype: Y+, Y+U

Bouwnummer: 146 t/m 152

Bladnummer: VT-H2-00b

Schaal: 1:100

Datum: 29-09-2021



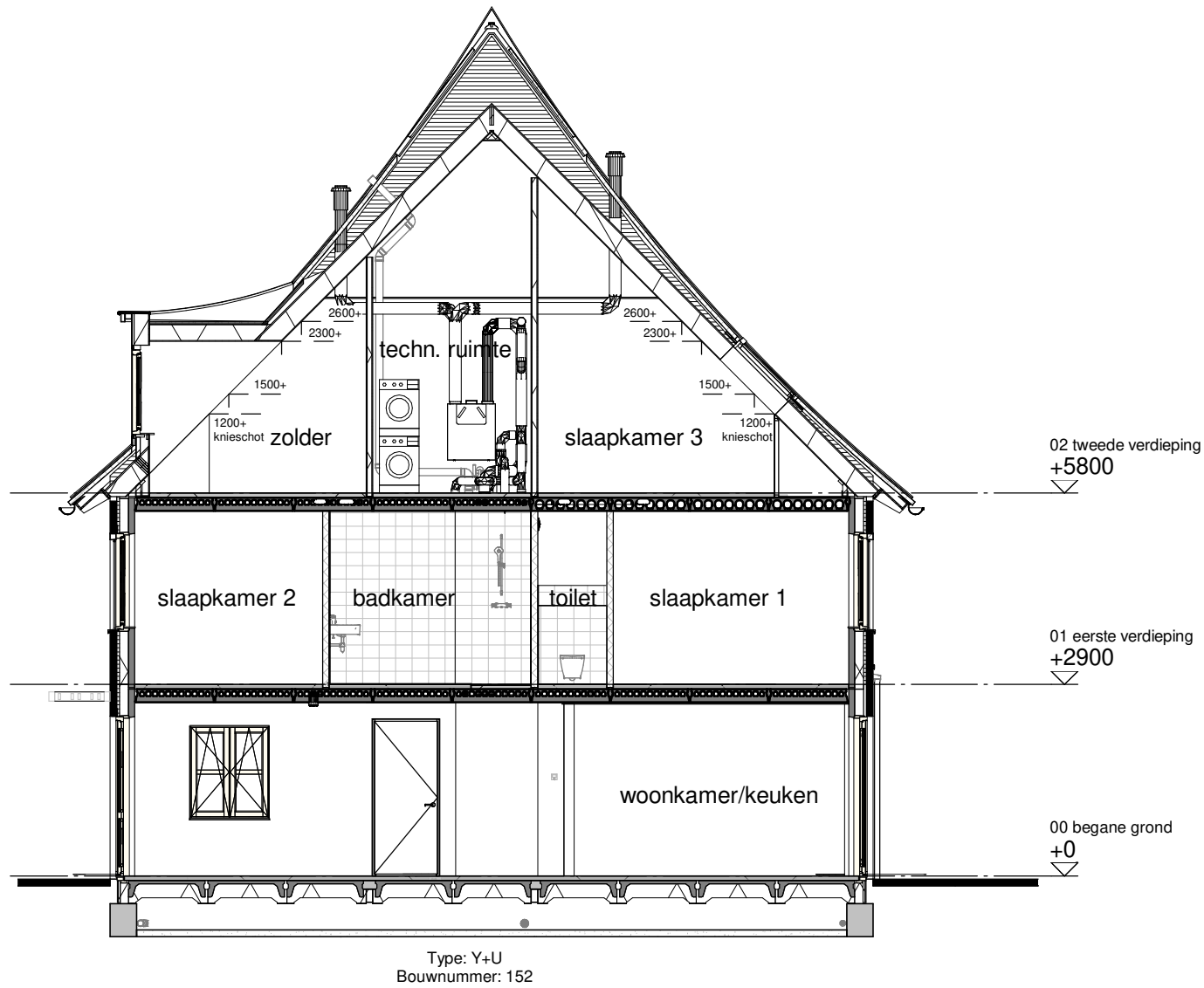

Doorsnede A

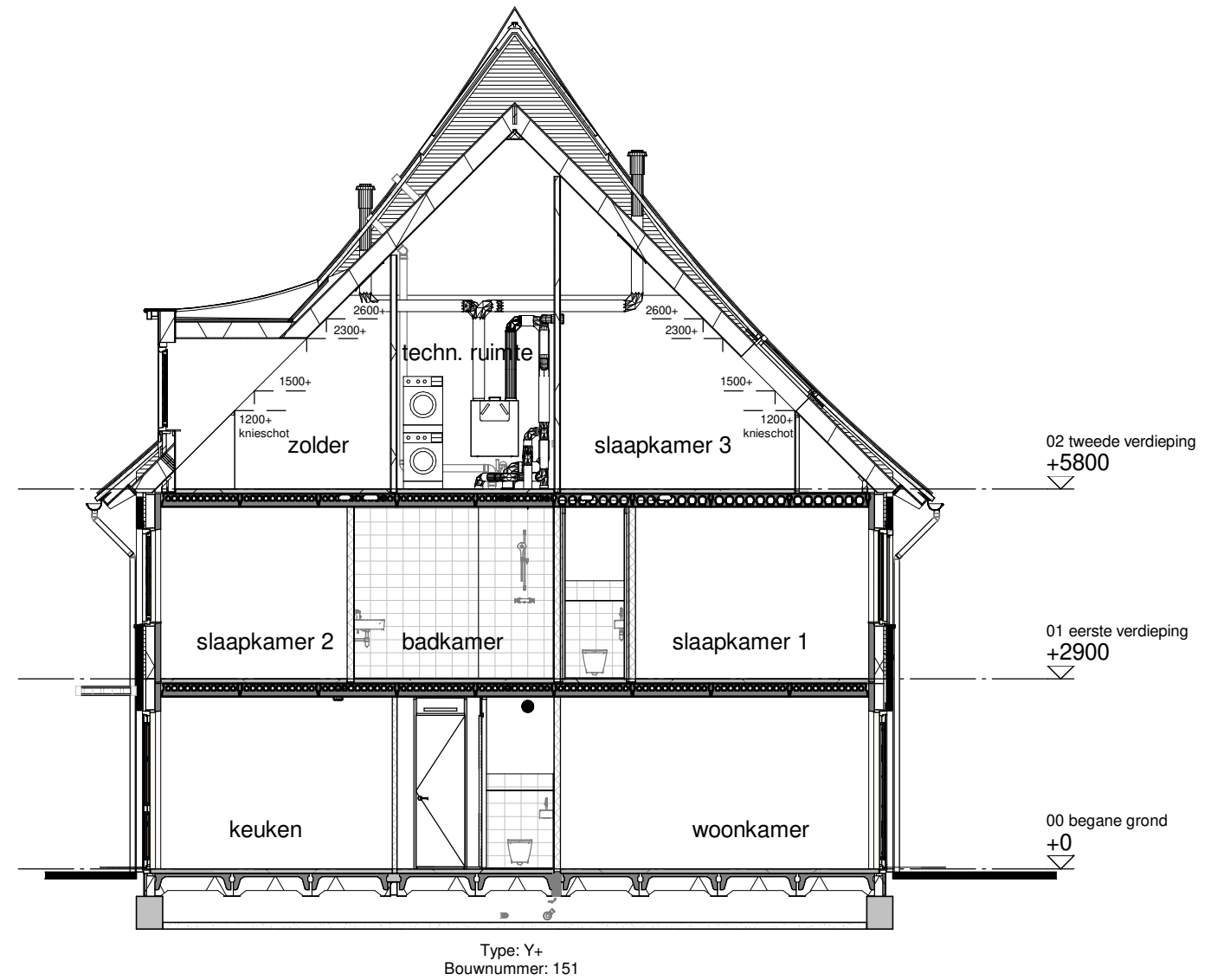

Doorsnede B

**ALLEMAAL  
YIELEYAAL**

Tekening: Doorsneden blok H2

Woningtype: Y+, Y+U

Bouwnummer: 146 t/m 152

Bladnummer: VT-H2-00c

Schaal: 1:100

Datum: 29-09-2021

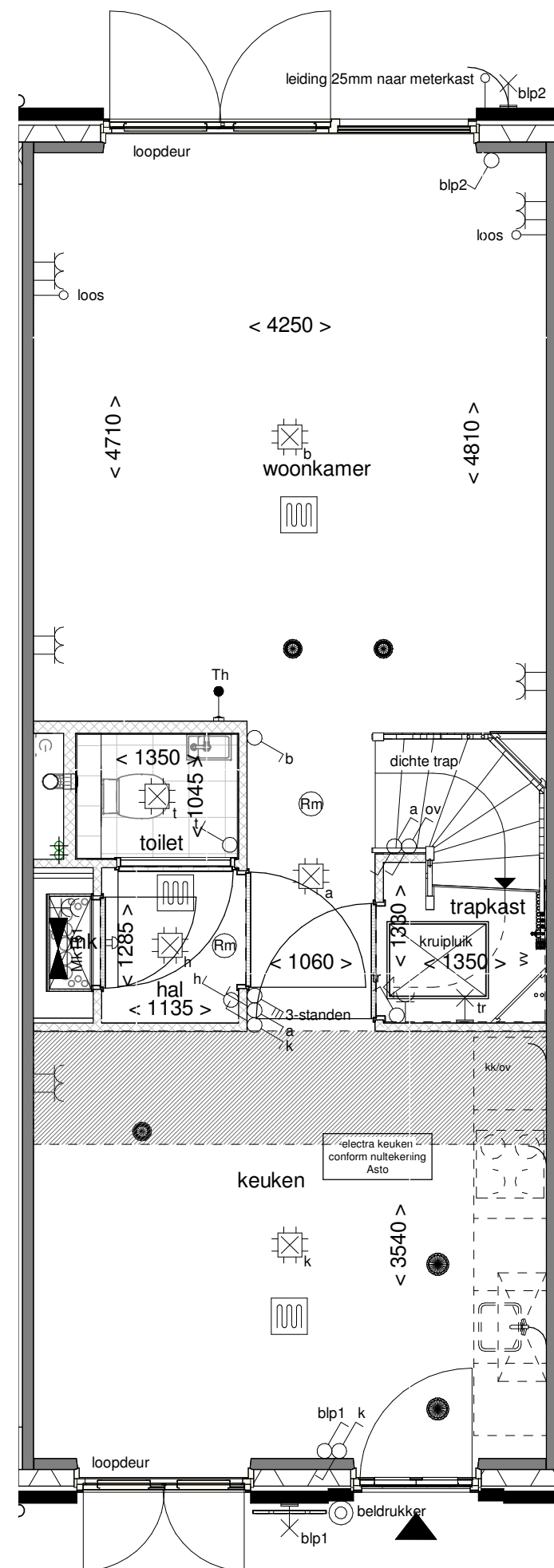

ALLEMAAL  
YIELEYAAL

Tekening: Begane grond

Woningtype: Y+

Bouwnummer: 151

Bladnummer: VT-H2-151a

Schaal: 1:50

Datum: 29-09-2021

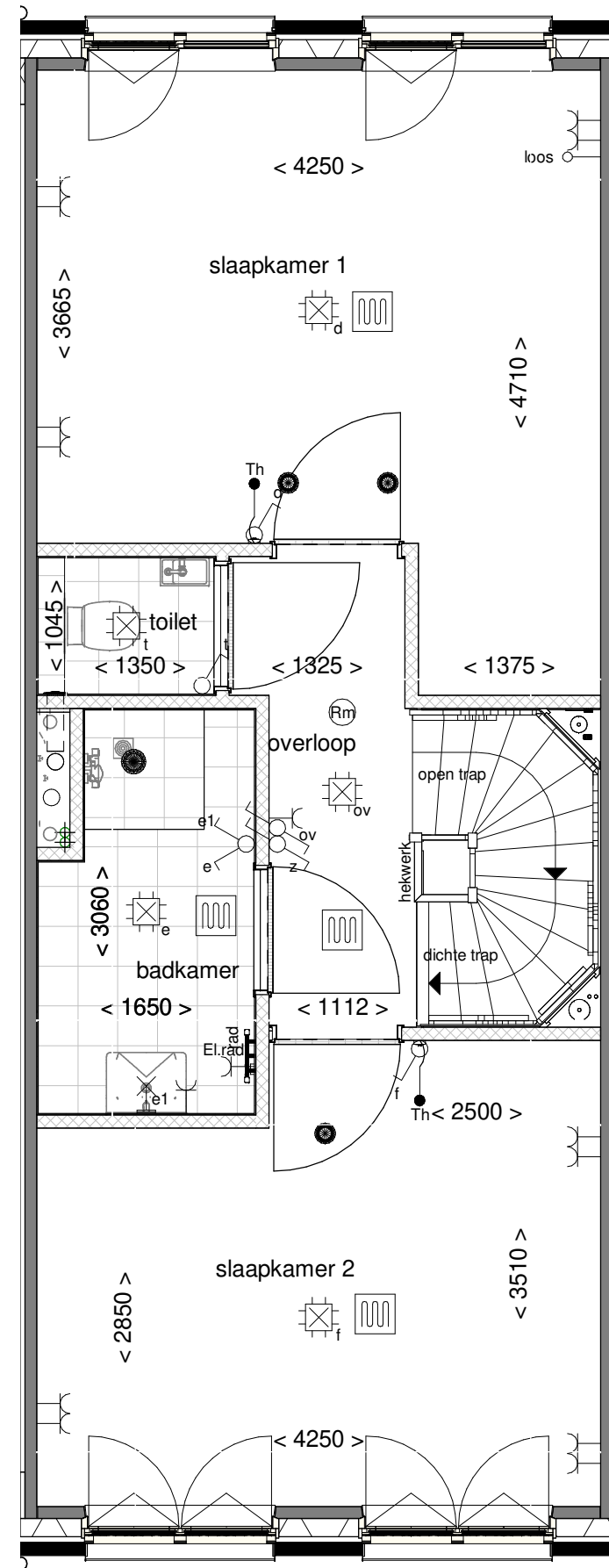

**ALLEMAAL  
YIELEYAAL**

Tekening: Eerste verdieping

Woningtype: Y+

Bouwnummer: 151

Bladnummer: VT-H2-151b

Schaal: 1:50

Datum: 29-09-2021



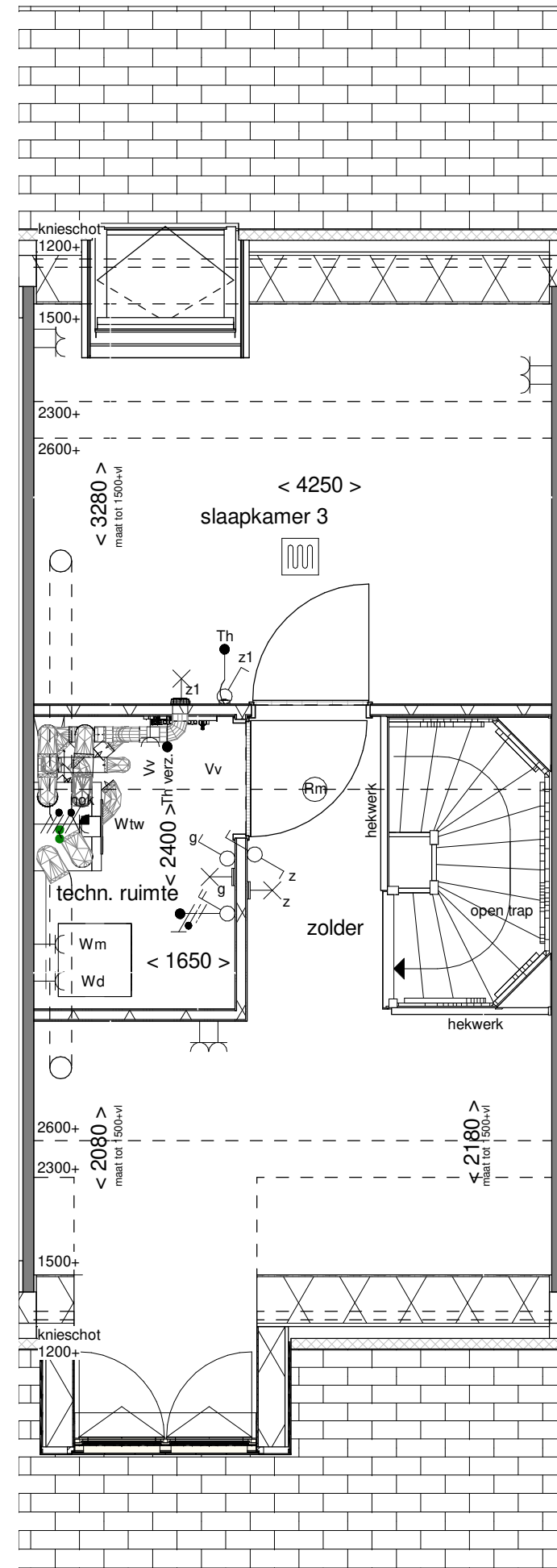

**ALLEMAAL  
YIELEYAAL**

Tekening: Tweede verdieping

Woningtype: Y+

Bouwnummer: 151

Bladnummer: VT-H2-151c

Schaal: 1:50

Datum: 29-09-2021

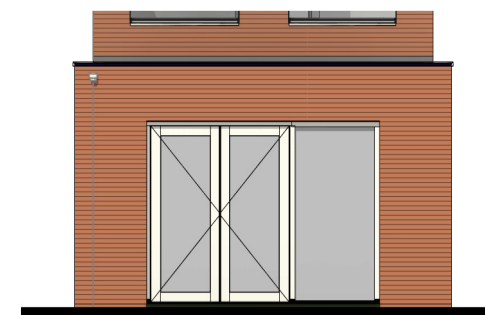
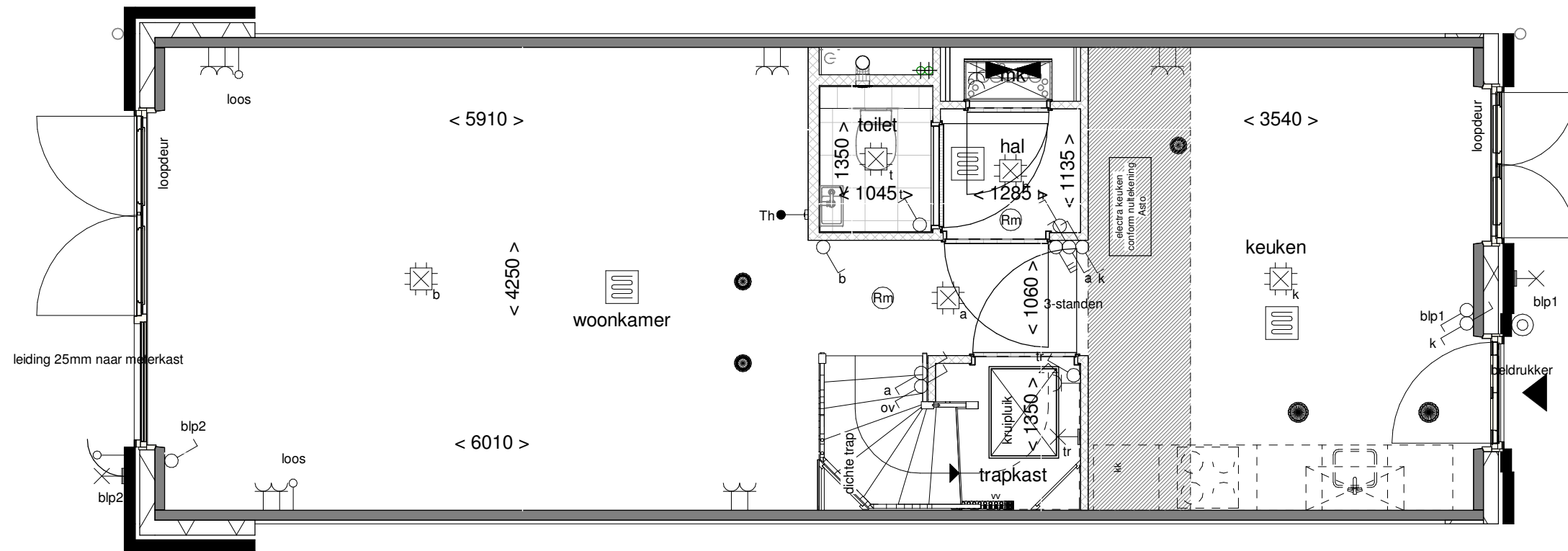

Achtergevel schaal 1:100

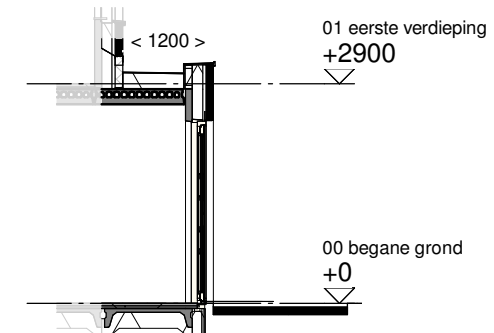

Doorsnede schaal 1:100

**ALLEMAAL  
YIELEYAAL**

Optie: **Uitbouw achtergevel  
1200mm**

Woningtype: **Y45+**

Bouwnummer: -

Optienummer: **0.A.Y.14**

Schaal: **1:50 / 1:100**

Datum: **29-09-2021**

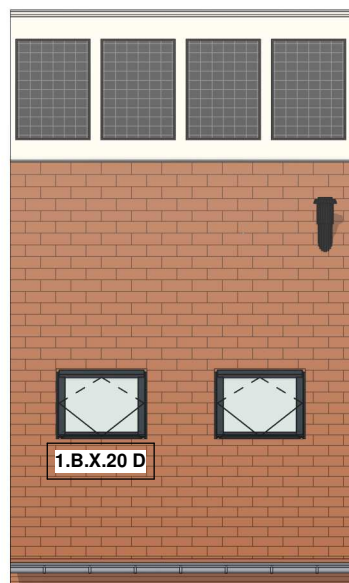
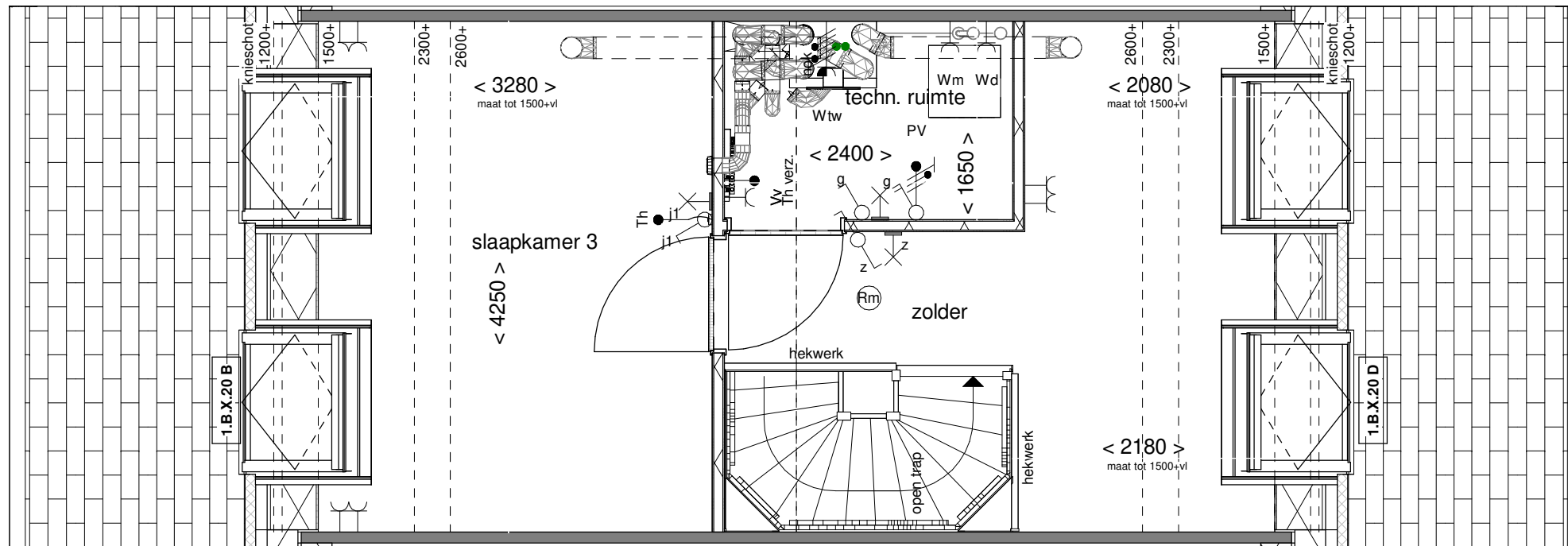

Voorgevel schaal 1:100

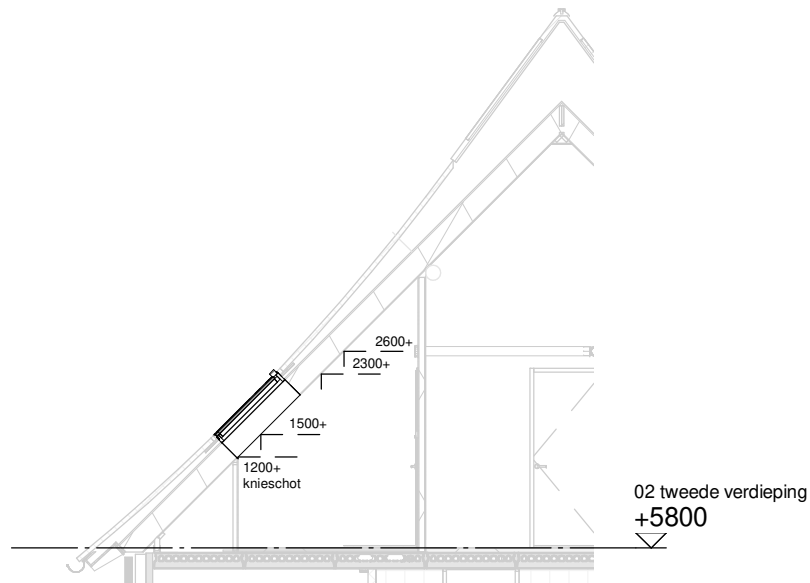

Doorsnede schaal 1:100

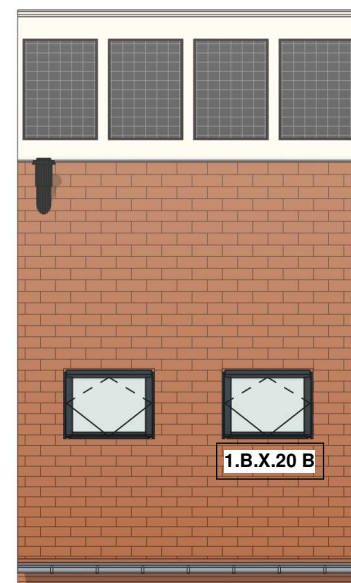

Achtergevel schaal 1:100

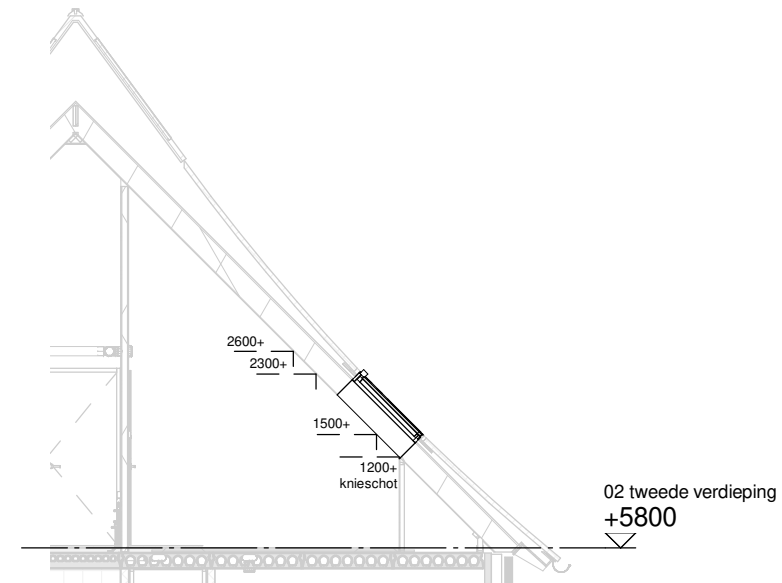

Doorsnede schaal 1:100

**ALLEMAAL  
YIELEYAAL**

Optie: Dakramen voor- en achtergevel

Woningtype: Y45+

Bouwnummer: -

Optienummer: 1.B.X.20

Schaal: 1:50 / 1:100

Datum: 29-09-2021



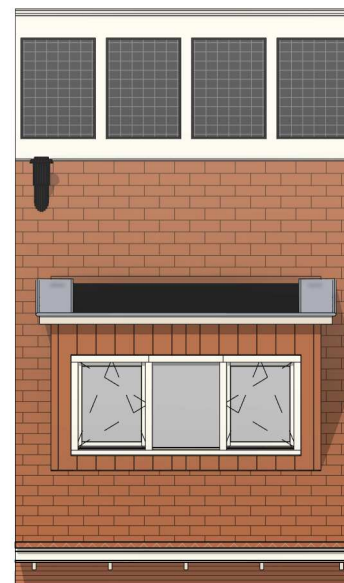
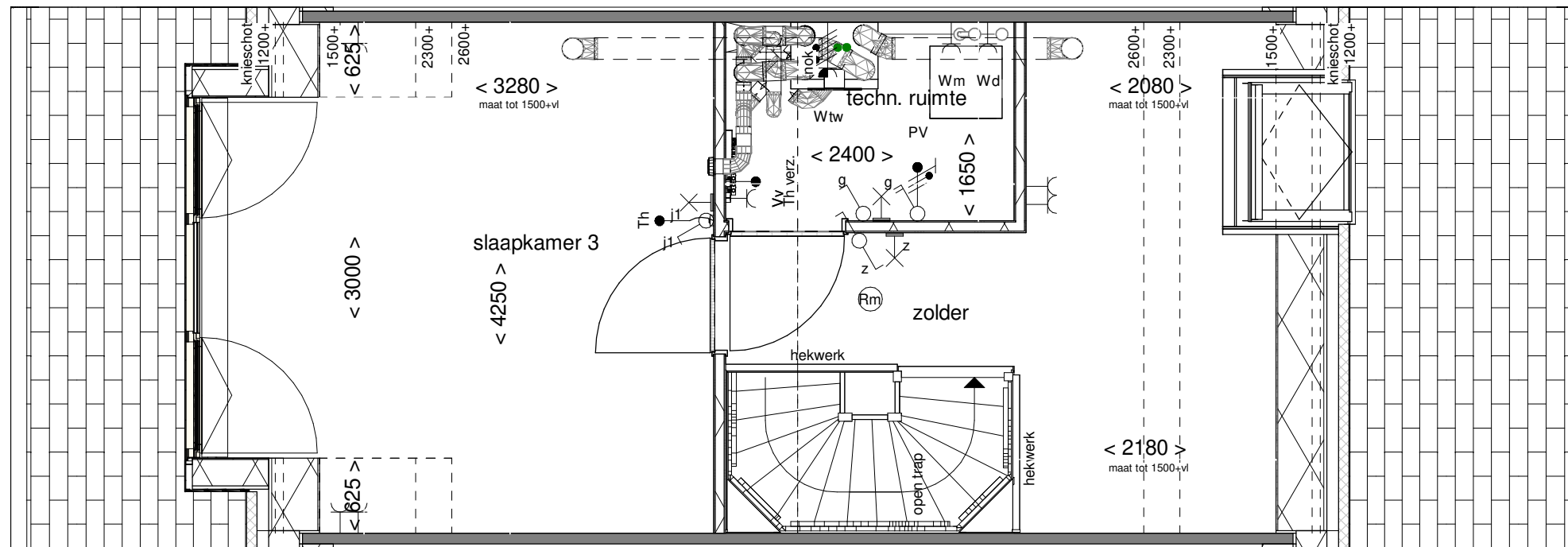

Achtergevel schaal 1:100

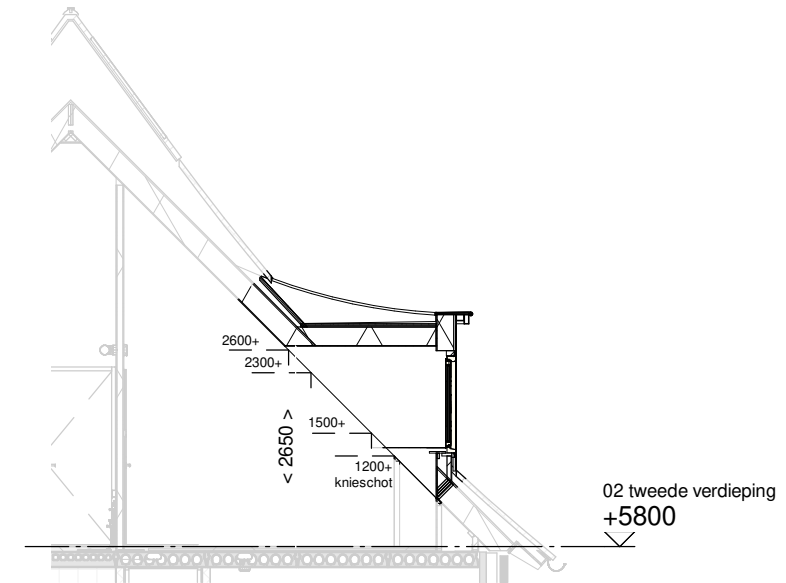

Doorsnede schaal 1:100

**ALLEMAAL  
YIELEYAAL**

Optie: Dakkapel  
achtergevel 3000mm

Woningtype: Y45+

Bouwnummer: -

Optienummer: 1.B.X.34

Schaal: 1:50 / 1:100

Datum: 29-09-2021

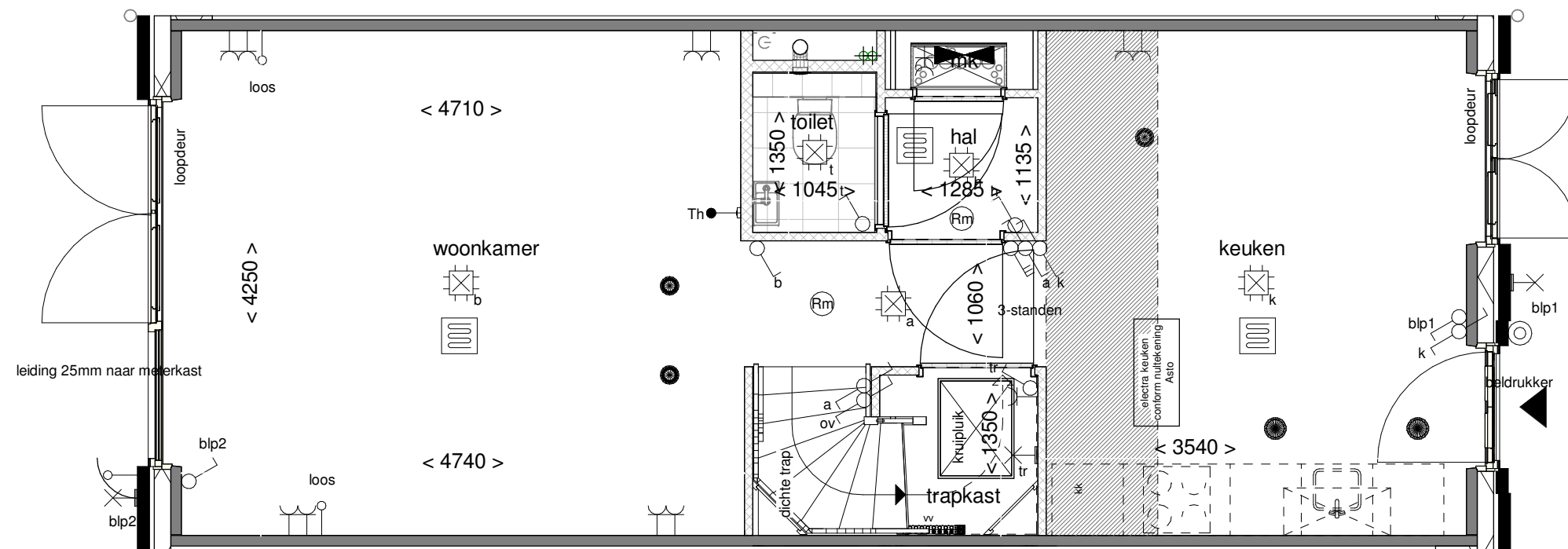

**ALLEMAAL  
YIELEYAAL**

Optie: Wand naast trap

Woningtype: Y45+

Bouwnummer: -

Optienummer: 1.C.Y.10

Schaal: 1:50

Datum: 29-09-2021

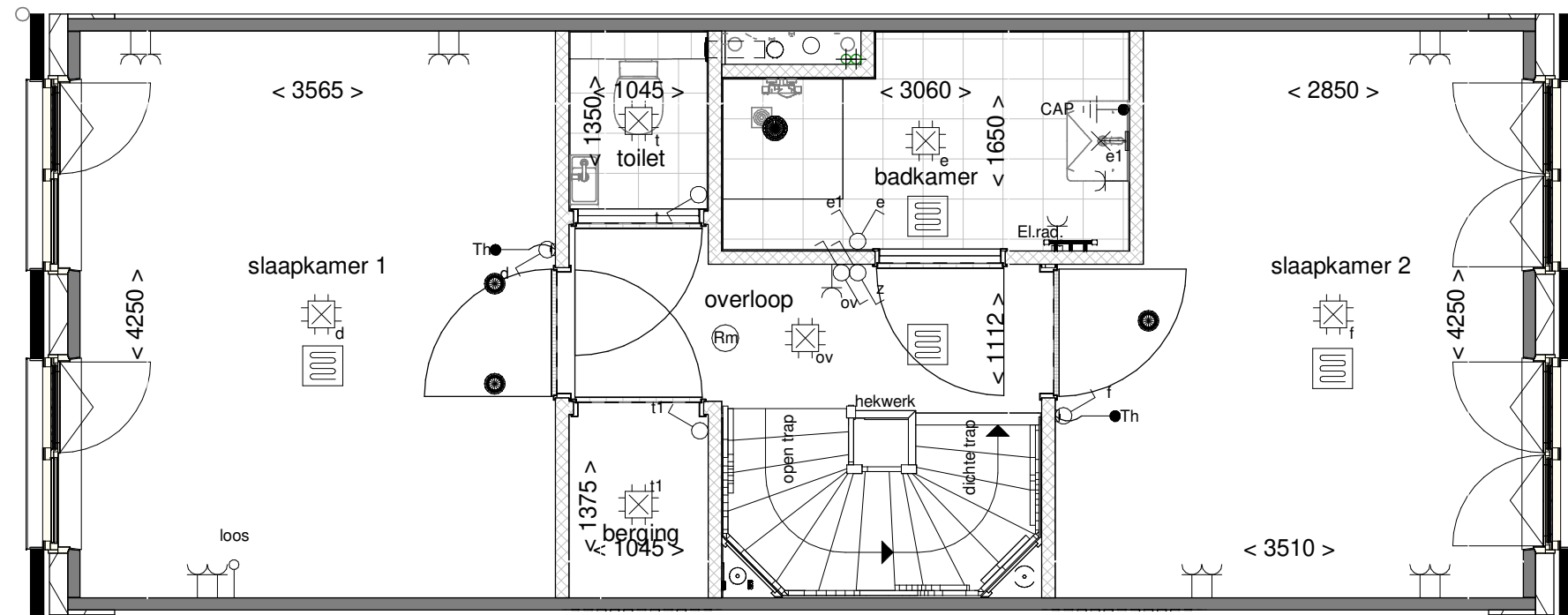

**ALLEMAAL  
YIELEYAAL**

Optie: Kast op overloop

Woningtype: Y45+

Bouwnummer: -

Optienummer: 1.C.Y.34

Schaal: 1:50

Datum: 29-09-2021



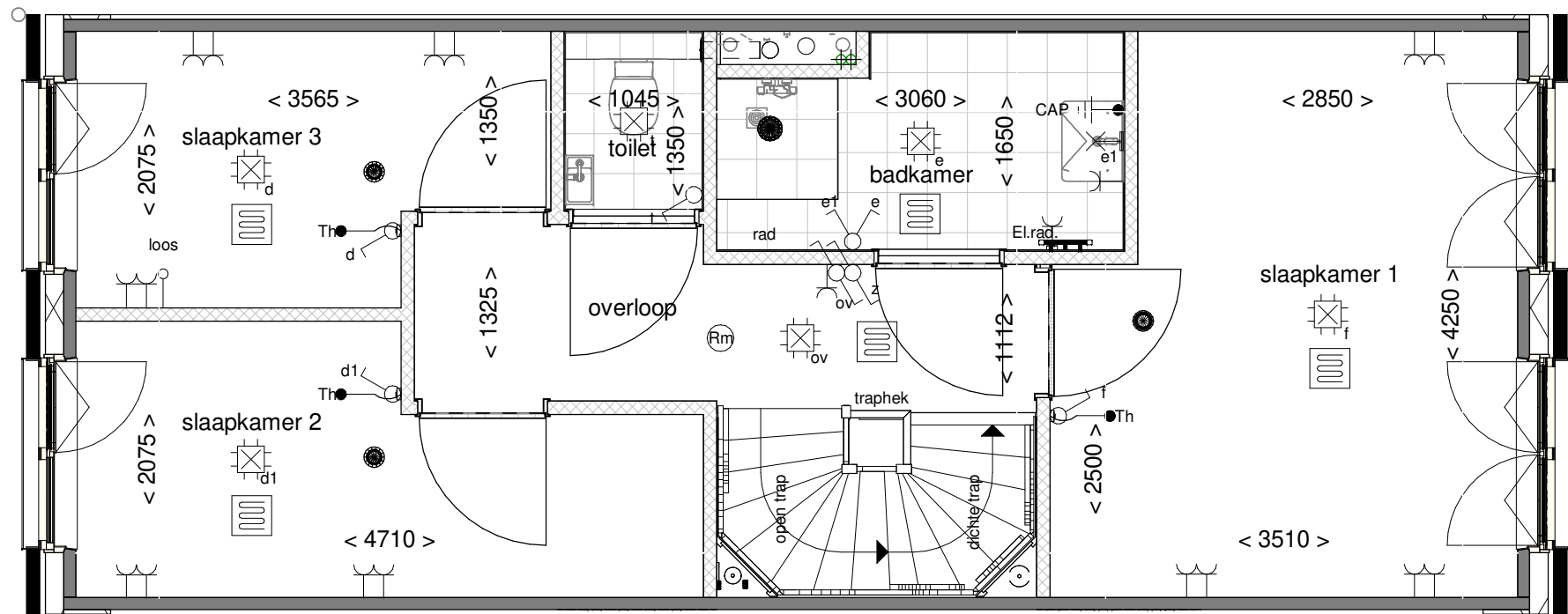

**ALLEMAAL  
YIELEYAAL**

Optie: Twee slaapkamers  
achterzijde

Woningtype: Y45+

Bouwnummer: -

Optienummer: 1.C.Y.36

Schaal: 1:50

Datum: 29-09-2021

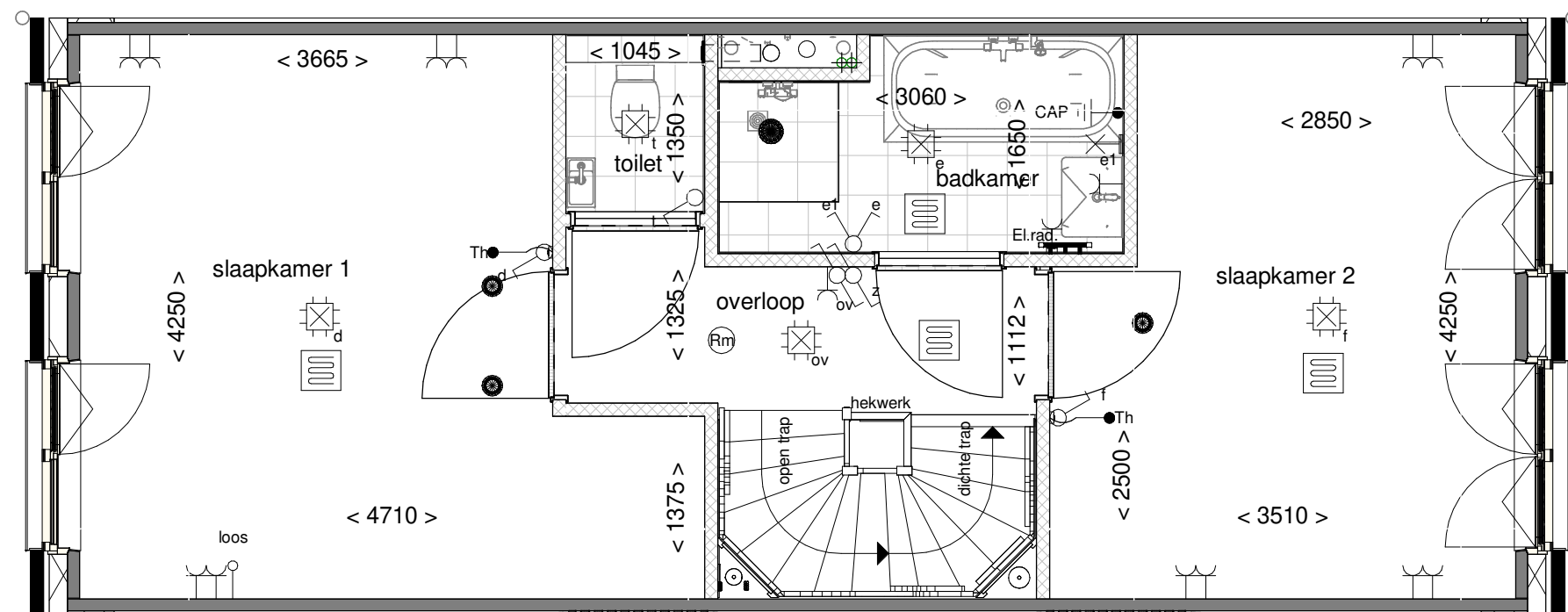

**ALLEMAAL  
YIELEYAAL**

Optie: **Bad in badkamer**

Woningtype: **Y45+**

Bouwnummer: **-**

Optienummer: **1.C.Y.40**

Schaal: **1:50**

Datum: **29-09-2021**

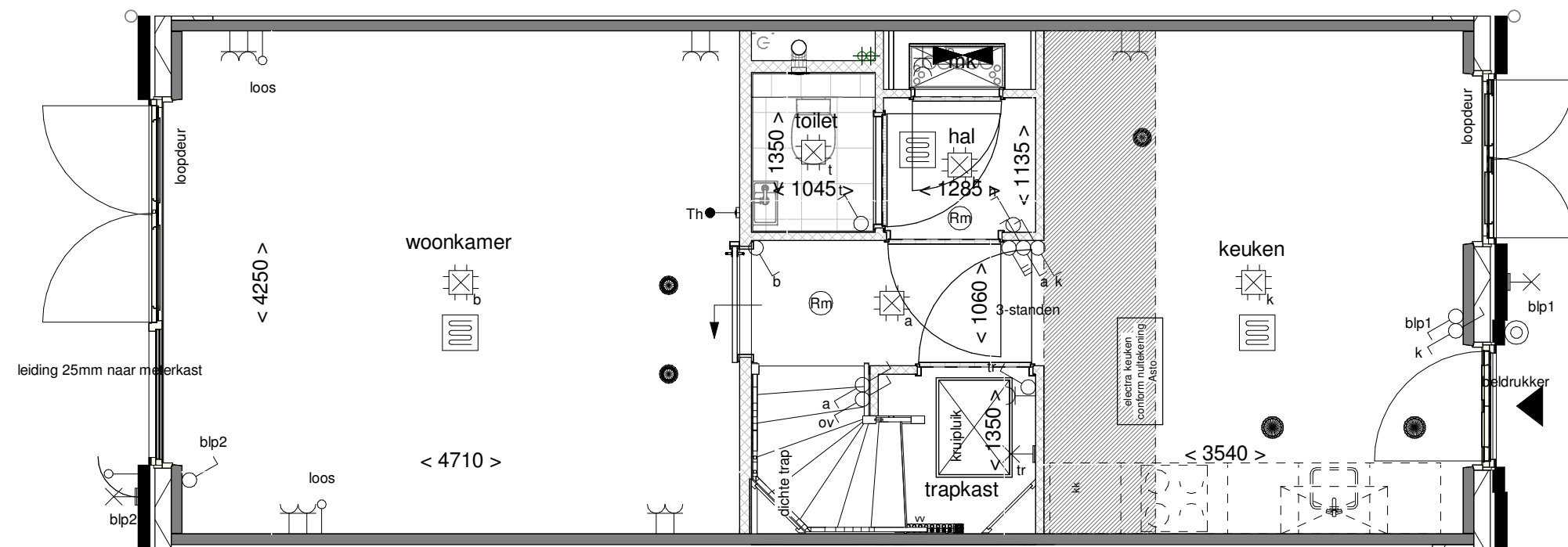

**ALLEMAAL  
YIELEYAAL**

Optie: Schuifdeur tussen woonk. en keuken

Woningtype: Y45+

Bouwnummer: -

Optienummer: 1.C.Y.42

Schaal: 1:50

Datum: 29-09-2021



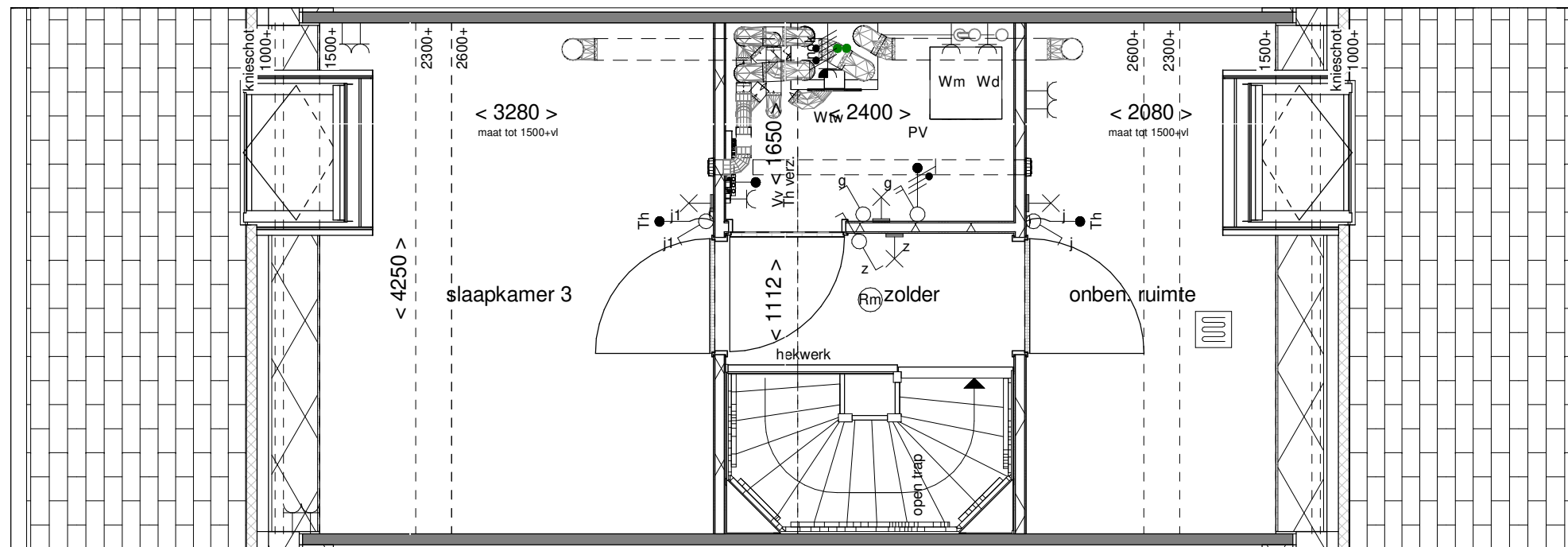

**ALLEMAAL  
YIELEYAAL**

Optie: Techn.- en onben.  
ruimte en slaapkamer

Woningtype: Y45+

Bouwnummer: -

Optienummer: 1.C.Y.78

Schaal: 1:50

Datum: 29-09-2021