

**ALLEMAAL
YIELEYAAL**

Tekening: Situatie totaal

Woningtype:

Bouwnummer:







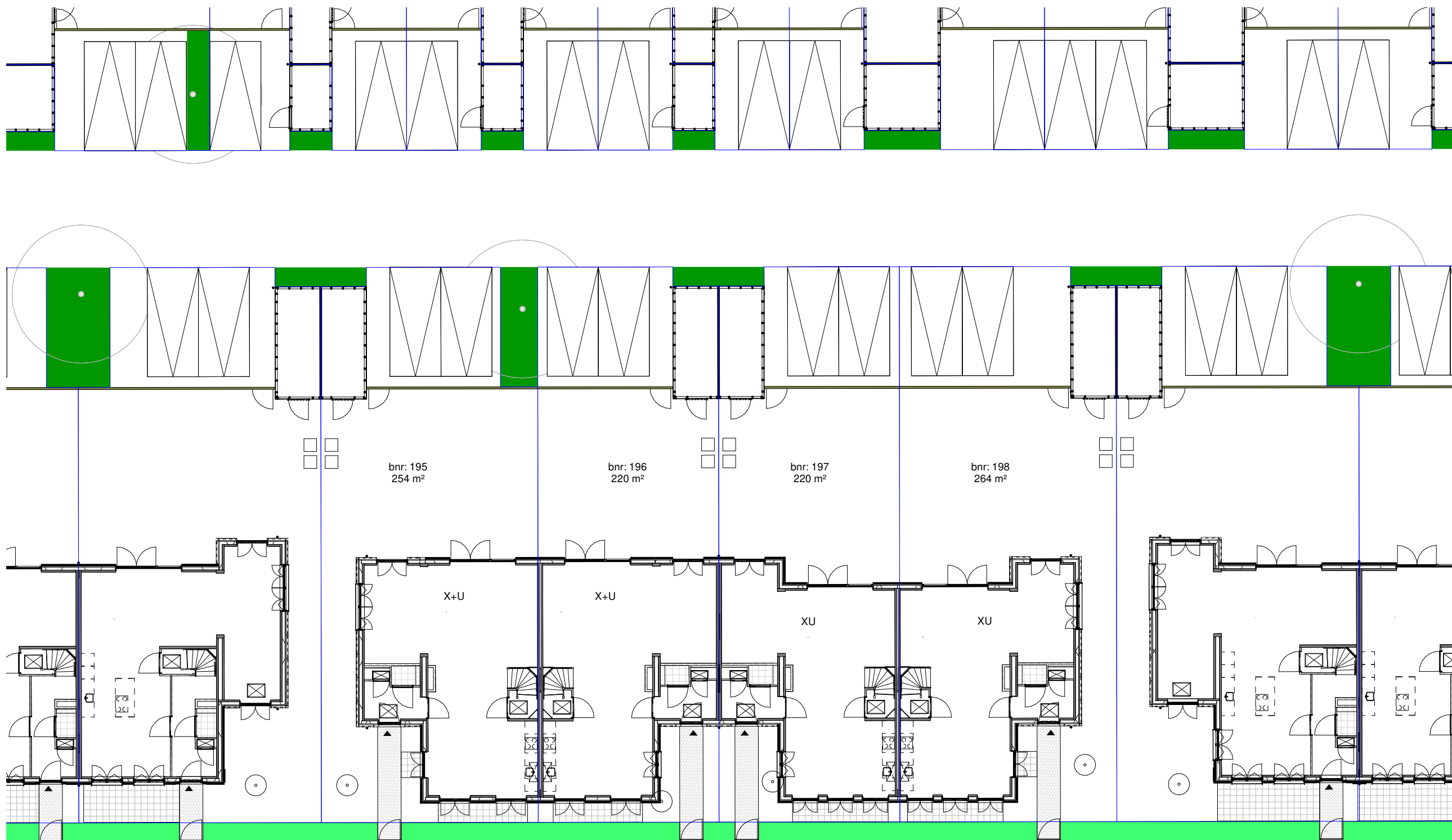

Bladnummer: VT-S-01

Schaal: 1:1000

Datum: 27-10-2021



Renvooi

-  - entree woning
-  - parkeervak eigen terrein
-  - erfgrans
-  - beplanting
type n.t.b. koper
-  - opstelplaats klike
-  - tuinhekje
-  - klinkerbestrating
-  - betontegels
300x300mm
-  - groen strook
-  - haag h=900mm
-  - haag h=1800mm
-  - bamboehek h=1800mm
-  - gaashek met klimplanten
en poort h=1600mm

parkeerplekken en posities
bomen en struiken zijn indicatief

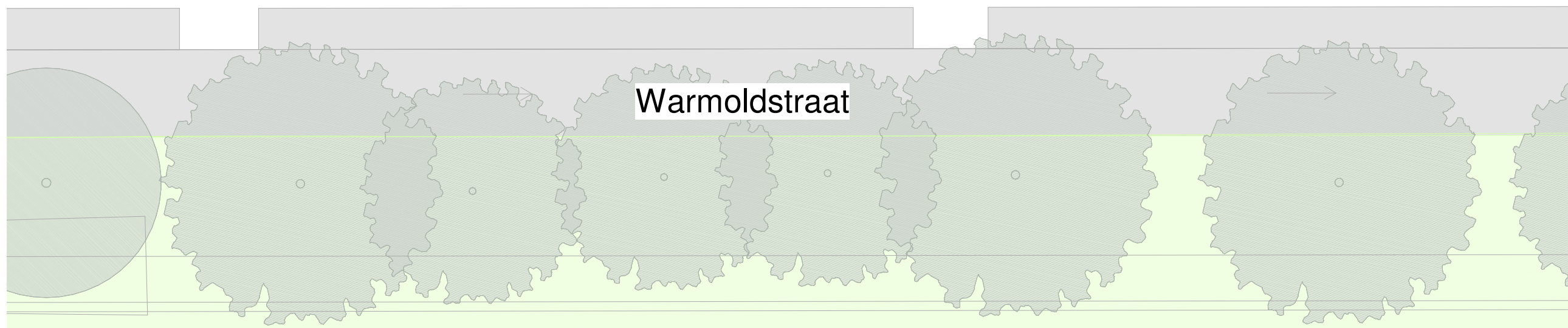

**ALLEMAAL
YIELEYAAL**

Tekening: Situatie Blok I6, I7

Woningtype: XU











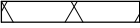

Bouwnummer: 195-198

Bladnummer: VT-S-19



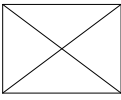

























Schaal: 1:200

Datum: 27-10-2021

Renvooi bouwkundig

	metselwerk kleur A
	dakpannen kleur oranje
	entree woning
	metselwerk
	isolatie
	dragende wand
	niet dragende binnenwand
	binnendeurkozijn (met bovenlicht)
	kruipluik
	opstelplaats wasmachine
	opstelplaats wasdroger
	
	principe opstelling keukenblok

Renvooi installaties

	aansluitpunt licht
	aansluitpunt licht, wand
	centraaldoos met lichtpunt
	armatuur aan de wand
	rookmelder
	aansluitpunt niet bedraad
	verdeelinrichting / meterkast / groepenkast
	beldrukker
	schel
	schakelaar, 1-polig
	werkschakelaar tbv PV-panelen
	schakelaar, 3-polig
	schakelaar, wissel
	schakelaar, kruis
	schakelaar, serie
	wandcontactdoos 1-voudig met beschermingscontact
	wandcontactdoos 2-voudig met beschermingscontact, verticaal
	wandcontactdoos 2-voudig met beschermingscontact
	thermostaatleiding, bedraad
	mechanische ventilatie-unit incl. warmteterugwinunit
	warmtepomp
	inblaasventiel mechanische ventilatie
	uitblaasventiel mechanische ventilatie
	verdeler vloerverwarming
	ruimte voorzien van vloerverwarming
	elektrische radiator
	kanalen in het zicht
	onbenoemde ruimte volgens krijstreepmethode

Disclaimer

De op deze tekeningen aangegeven maten zijn circa maten in millimeters en tussen de wanden / vloeren gemeten, waarbij geen rekening is gehouden met enige wandafwerking, plinten, aftimmering, ect. In verband met de nauwkeurige uitwerking van details, constructie, maatvoering, materialen e.d. kunnen er kleine afwijkingen ontstaan ten opzichte van de nu vermelde gegevens. Deze geringe afwijkingen geven geen aanleiding tot verrekening. Aan de op deze tekening aangegeven maten kunnen derhalve geen rechten worden ontleend. De op deze tekeningen aangegeven maatvoering is niet geschikt voor opdrachten aan derden door koper(s). De posities van aansluitingen en installatie onderdelen zijn indicatief op tekening aangegeven. De exacte aantallen en posities zullen na berekening in het werk door de installateurs worden bepaald en kunnen afwijken van deze tekening.

**ALLEMAAL
YIELEYAAL**

Tekening: Renvooi

Woningtype: -

Bouwnummer: -

Bladnummer: VT-0-00c

Schaal: -

Datum: 27-10-2021



Type: X+U
bwnr: 195

Type: X+U
bwnr: 196

Type: XU
bwnr: 197

Type: XU
bwnr: 198



Type: XU
bwnr: 198

Type: XU
bwnr: 197

Type: X+U
bwnr: 196

Type: X+U
bwnr: 195

ALLEMAAL
YIELEYAAL

Tekening: Gevels blok 16,17

Woningtype: X+U, XU

Bouwnummer: 195 t/m 198

Bladnummer: VT-16, 17-00a

Schaal: 1:150

Datum: 27-10-2021

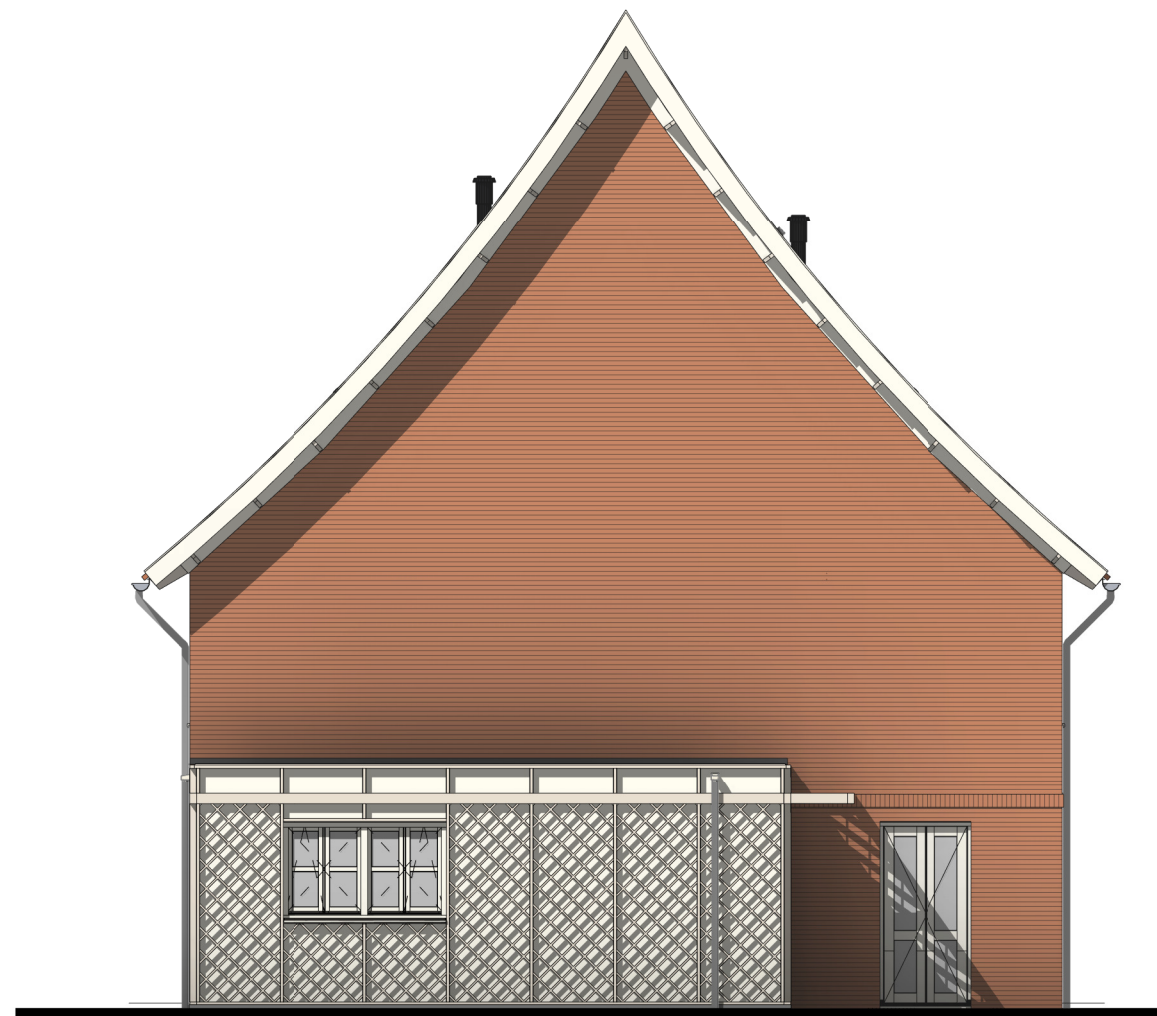

Type: X+U
Bouwnummer: 195

Linker zijgevel



Type: XU
Bouwnummer: 198

Rechter zijgevel

**ALLEMAAL
YIELEYAAL**

Tekening: Zijgevels blok I6,I7

Woningtype: X+U, XU

Bouwnummer: 195 t/m 198

Bladnummer: VT-I6, I7-00b

Schaal: 1:100

Datum: 27-10-2021

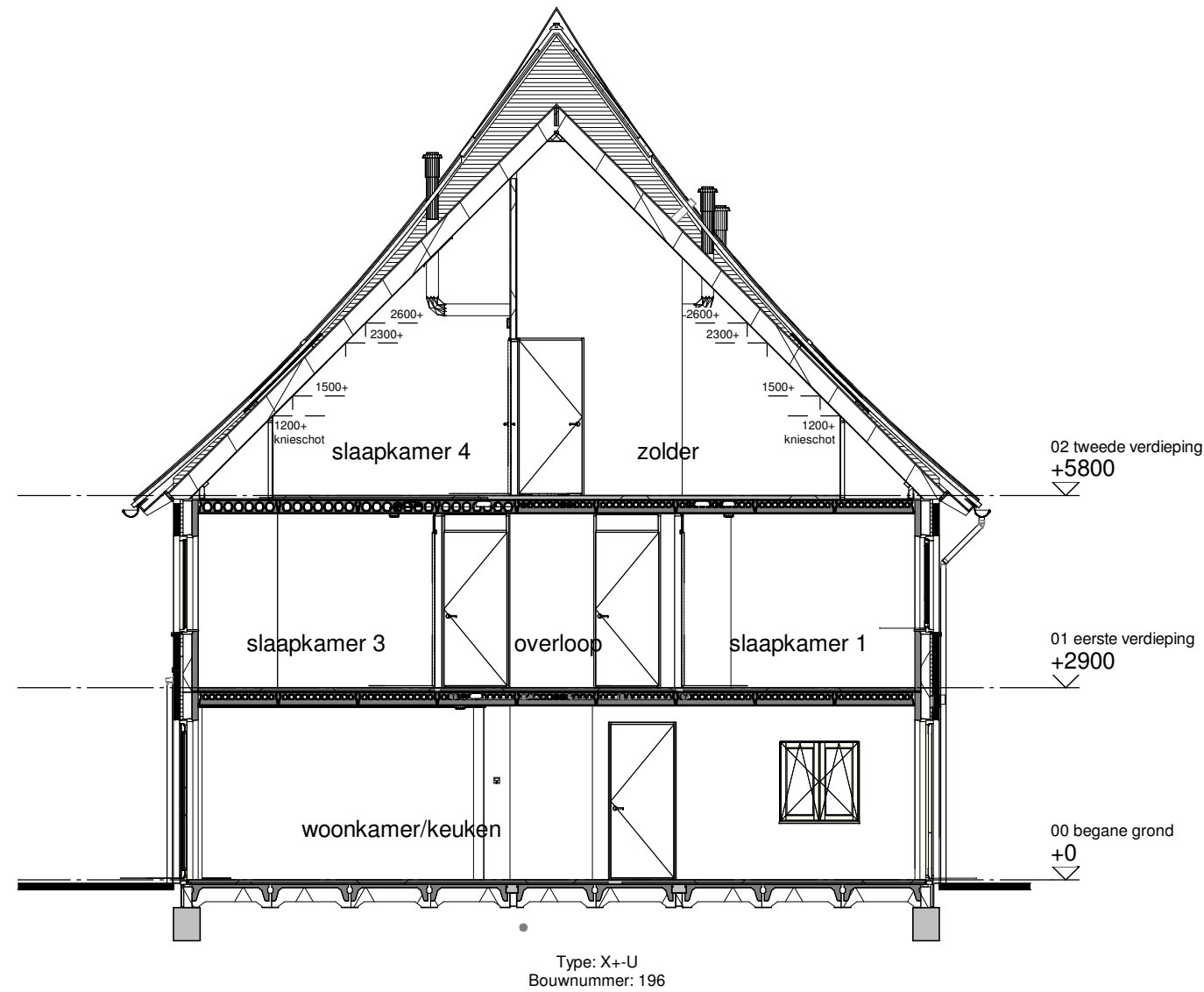

Doorsnede A

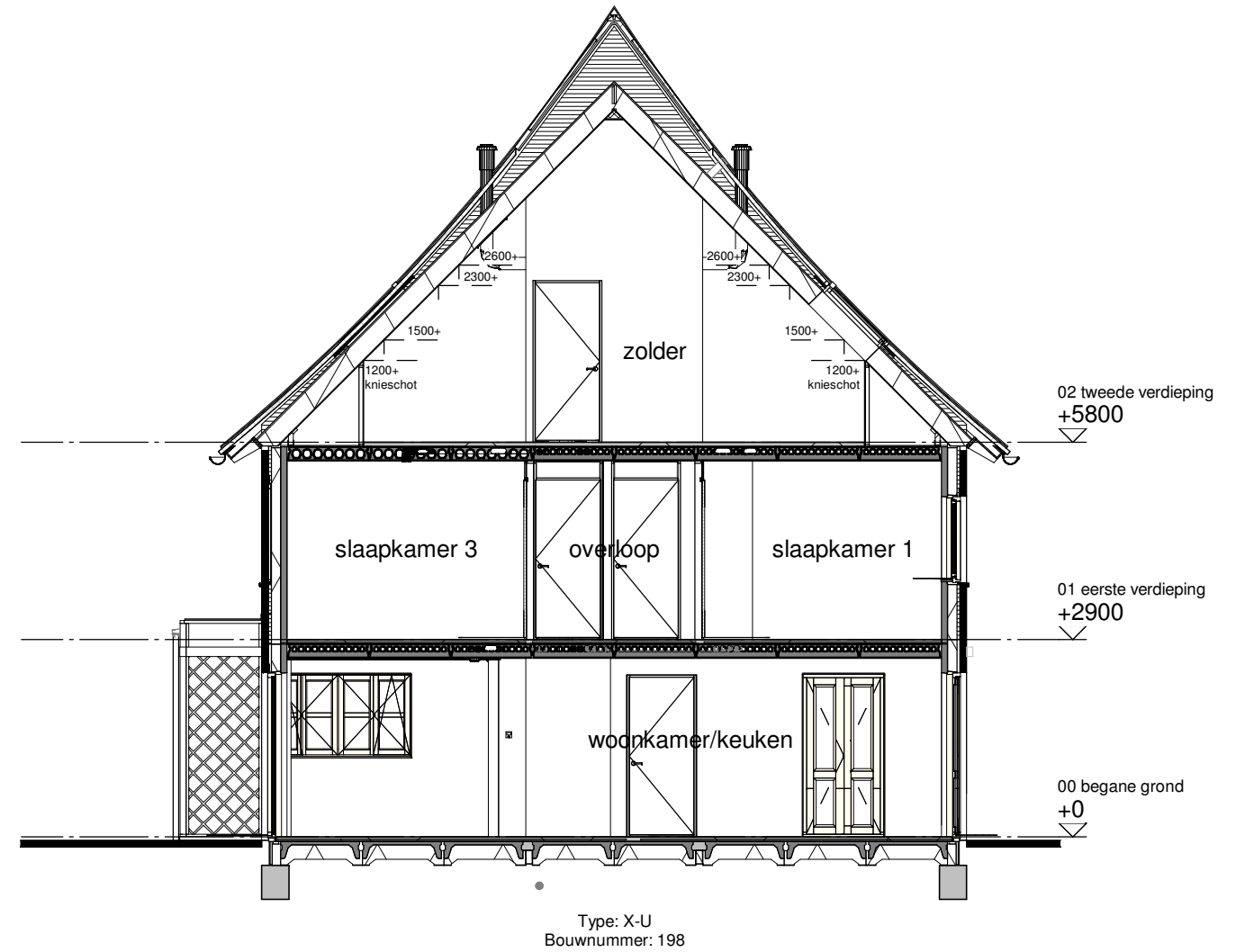

Doorsnede B

ALLEMAAL
VIELEJAAL

Tekening: Doorsneden blok I6,I7

Woningtype: X+-U, X-U

Bouwnummer: 195-198

Bladnummer: VT-I6, I7-00c

Schaal: 1:100

Datum: 27-10-2021

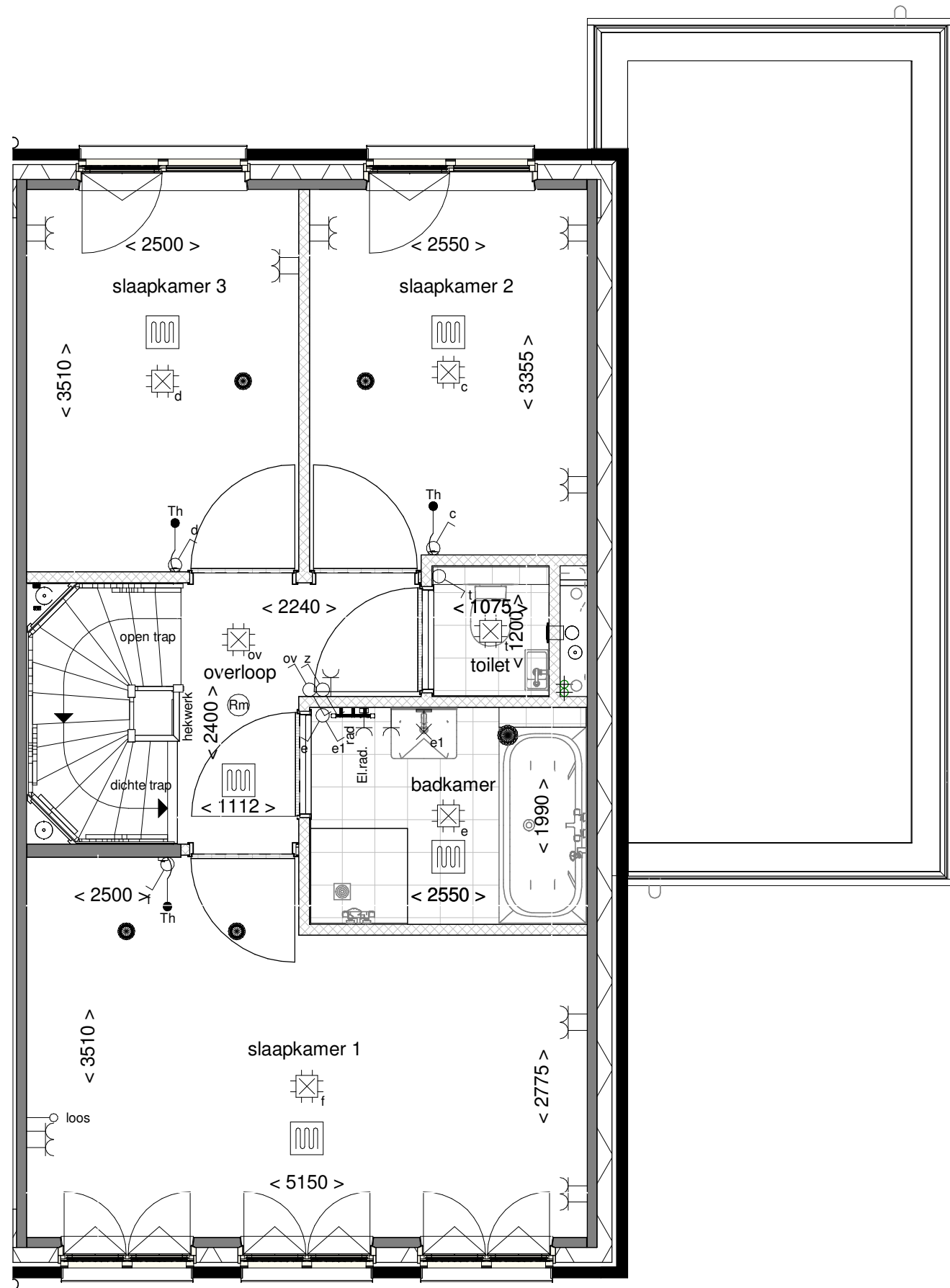

**ALLEMAAL
VIELEJAAL**

Tekening: Eerste verdieping

Woningtype: XU

Bouwnummer: 198

Bladnummer: VT-17-198b

Schaal: 1:50

Datum: 27-10-2021

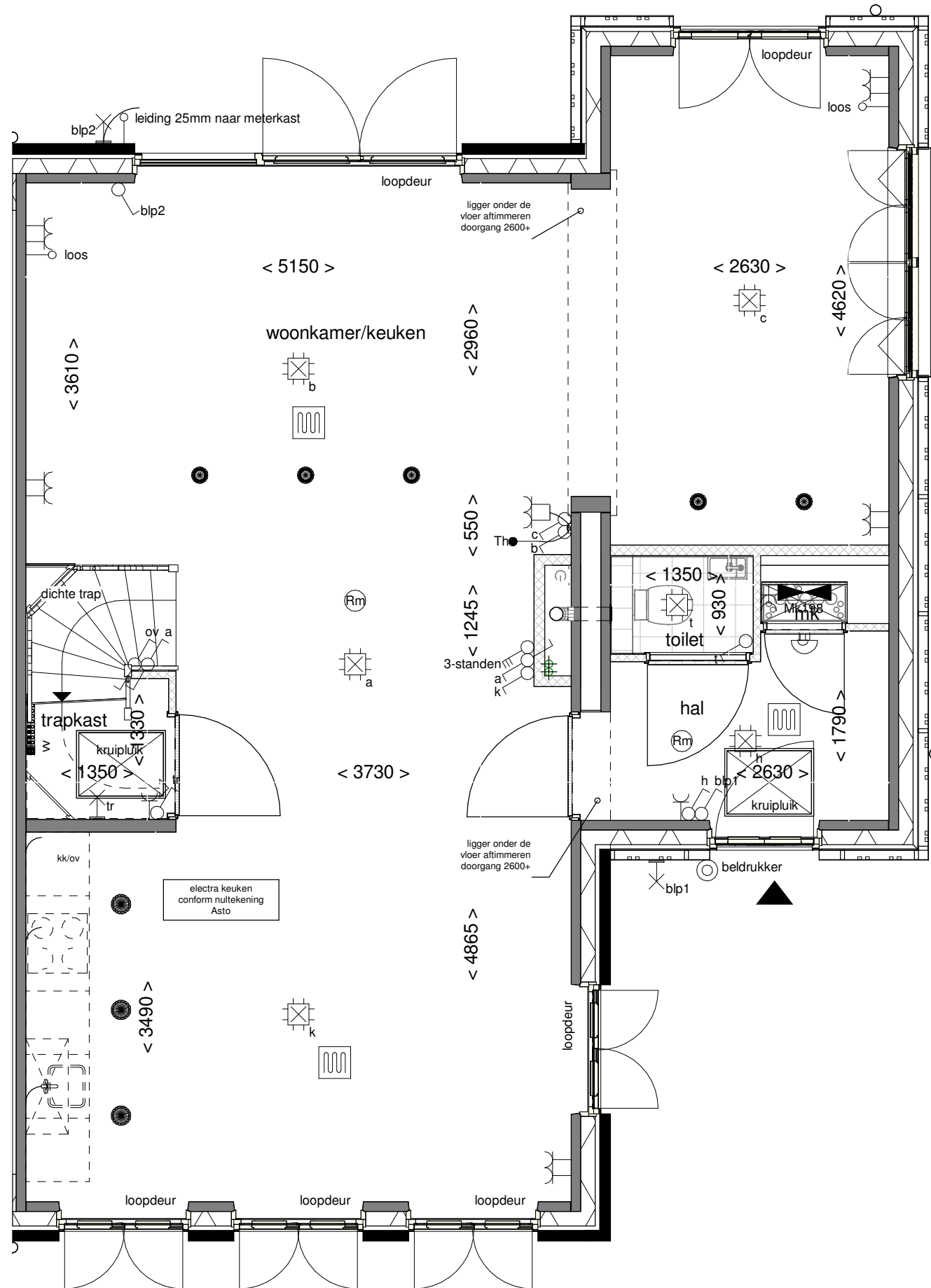

**ALLEMAAL
VIELEVAAL**

Tekening: Begane grond

Woningtype: XU

Bouwnummer: 198

Bladnummer: VT-17-198a

Schaal: 1:50

Datum: 27-10-2021

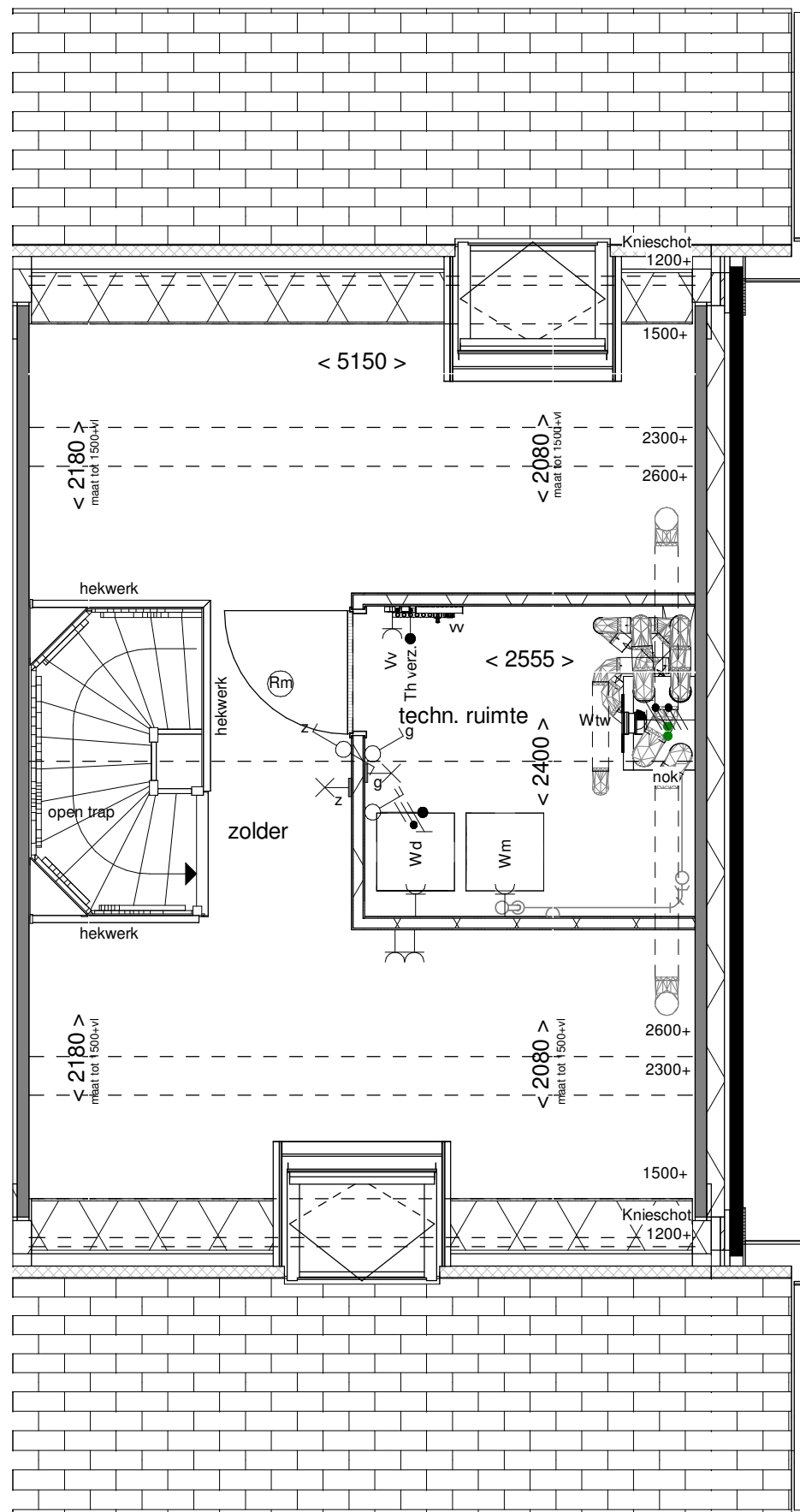

**ALLEMAAL
YIELEYAAL**

Tekening: Tweede verdieping

Woningtype: XU

Bouwnummer: 198

Bladnummer: VT-17-198c

Schaal: 1:50

Datum: 27-10-2021

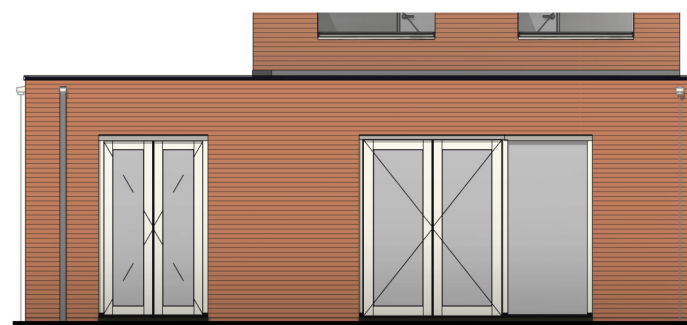
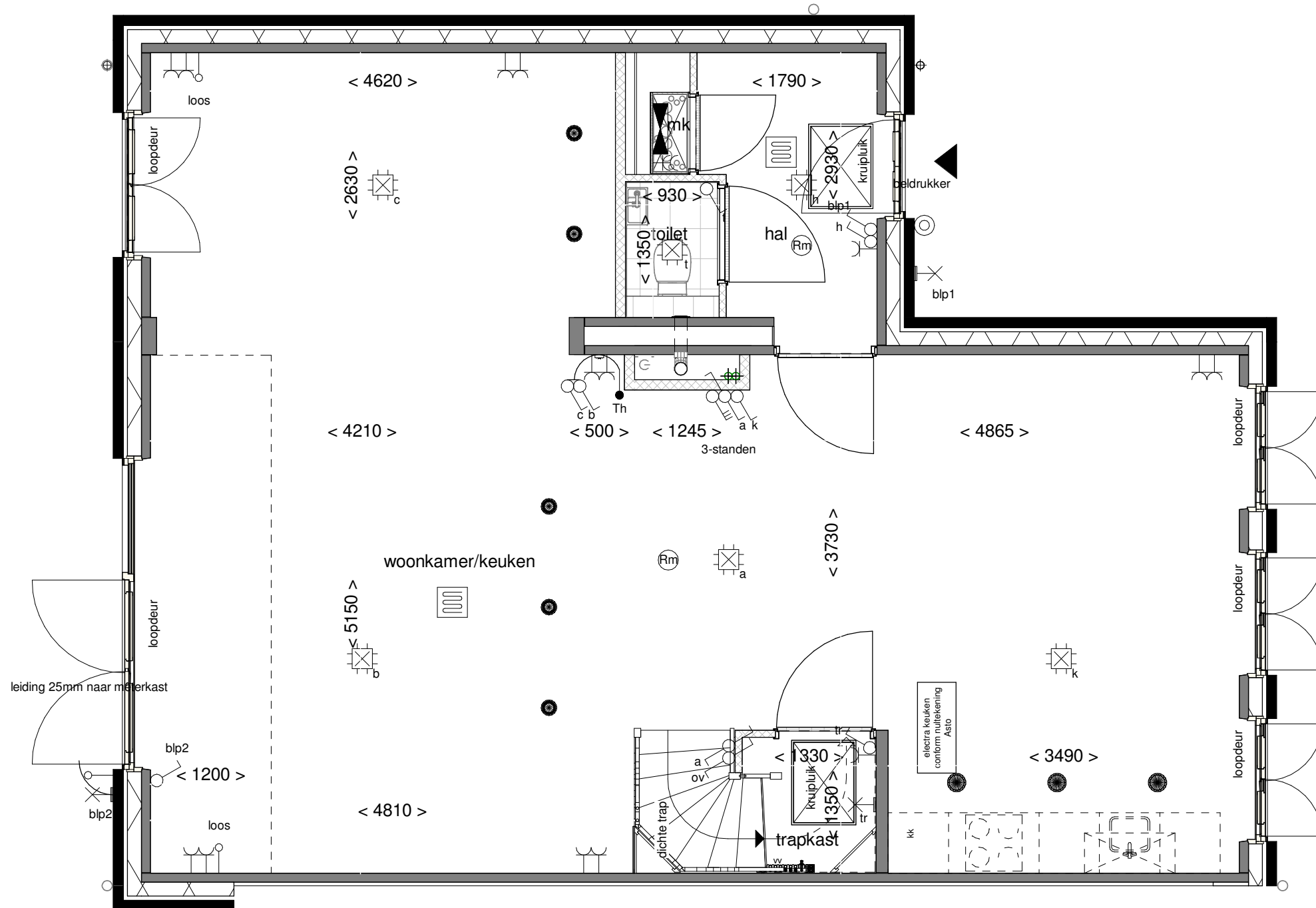

Achtergevel schaal 1:100

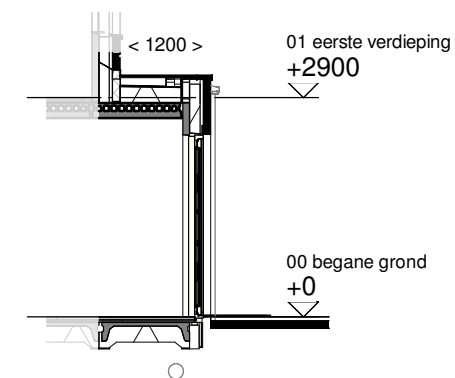

Doorsnede schaal 1:100

**ALLEMAAL
VIELEJAAR**

Optie: **Uitbouw achtergevel
1200mm**

Woningtype: **X54U**

Bouwnummer: -

Optienummer: **1.A.X.12**

Schaal: **1:50 / 1:100**

Datum: **29-09-2021**

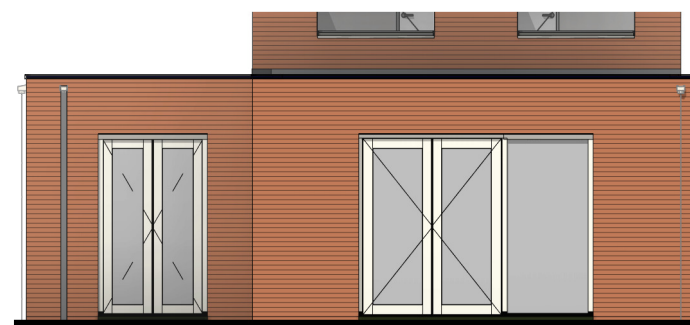
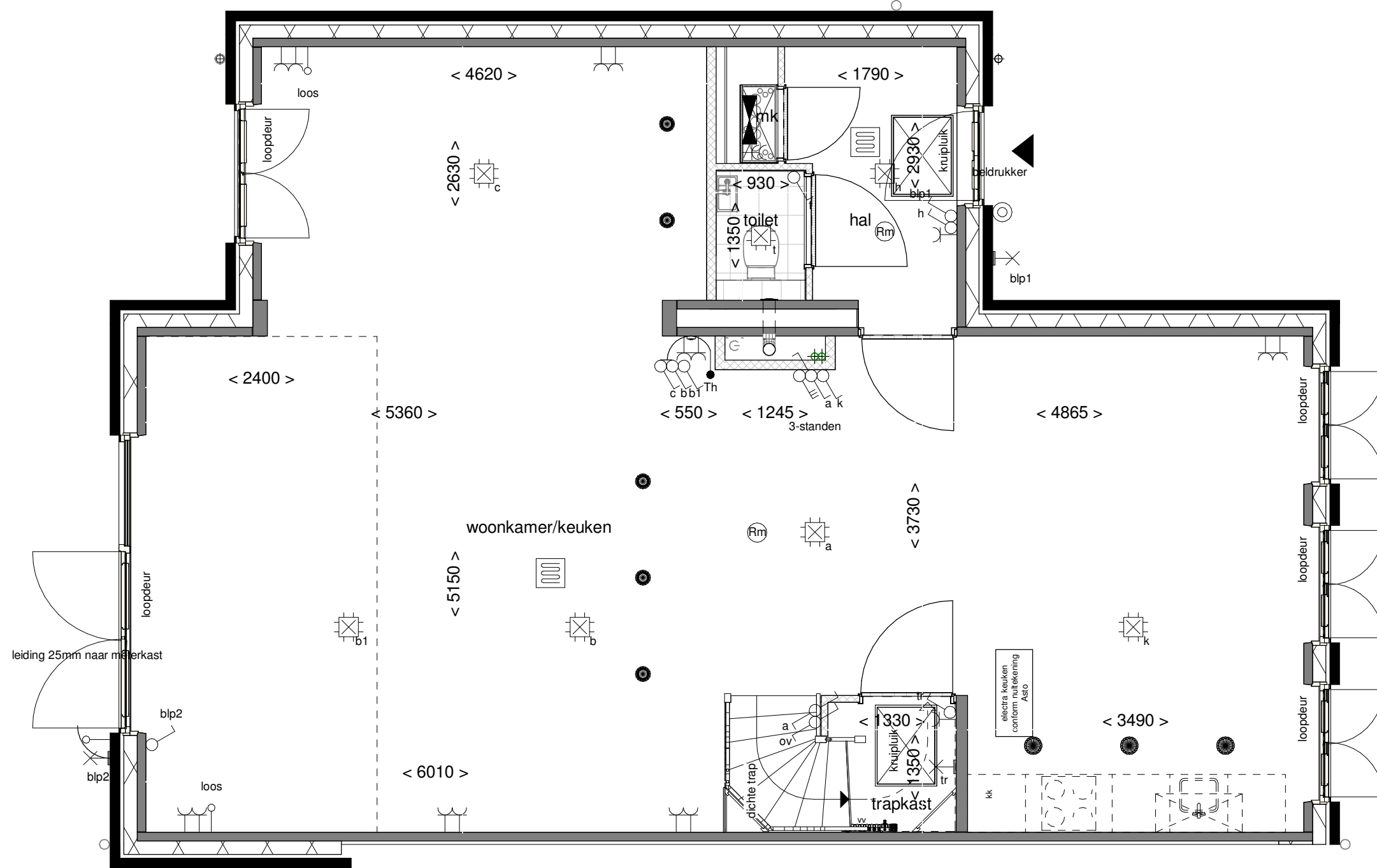

Achtergevel schaal 1:100

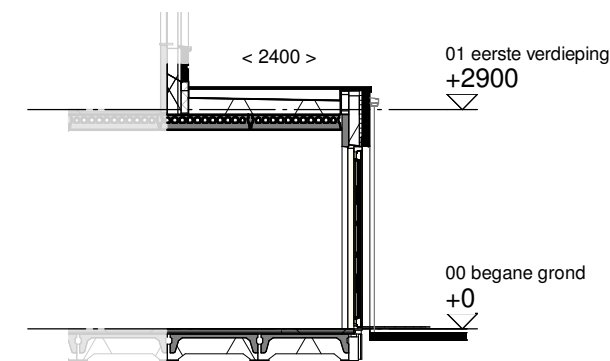

Doorsnede schaal 1:100

**ALLEMAAL
VIELEJAAR**

Optie: **Uitbouw achtergevel
2400mm**

Woningtype: **X54U**

Bouwnummer: **-**

Optienummer: **1.A.X.32**

Schaal: **1:50 / 1:100**

Datum: **29-09-2021**

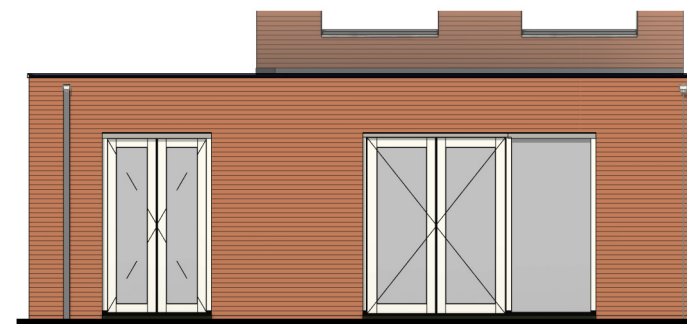
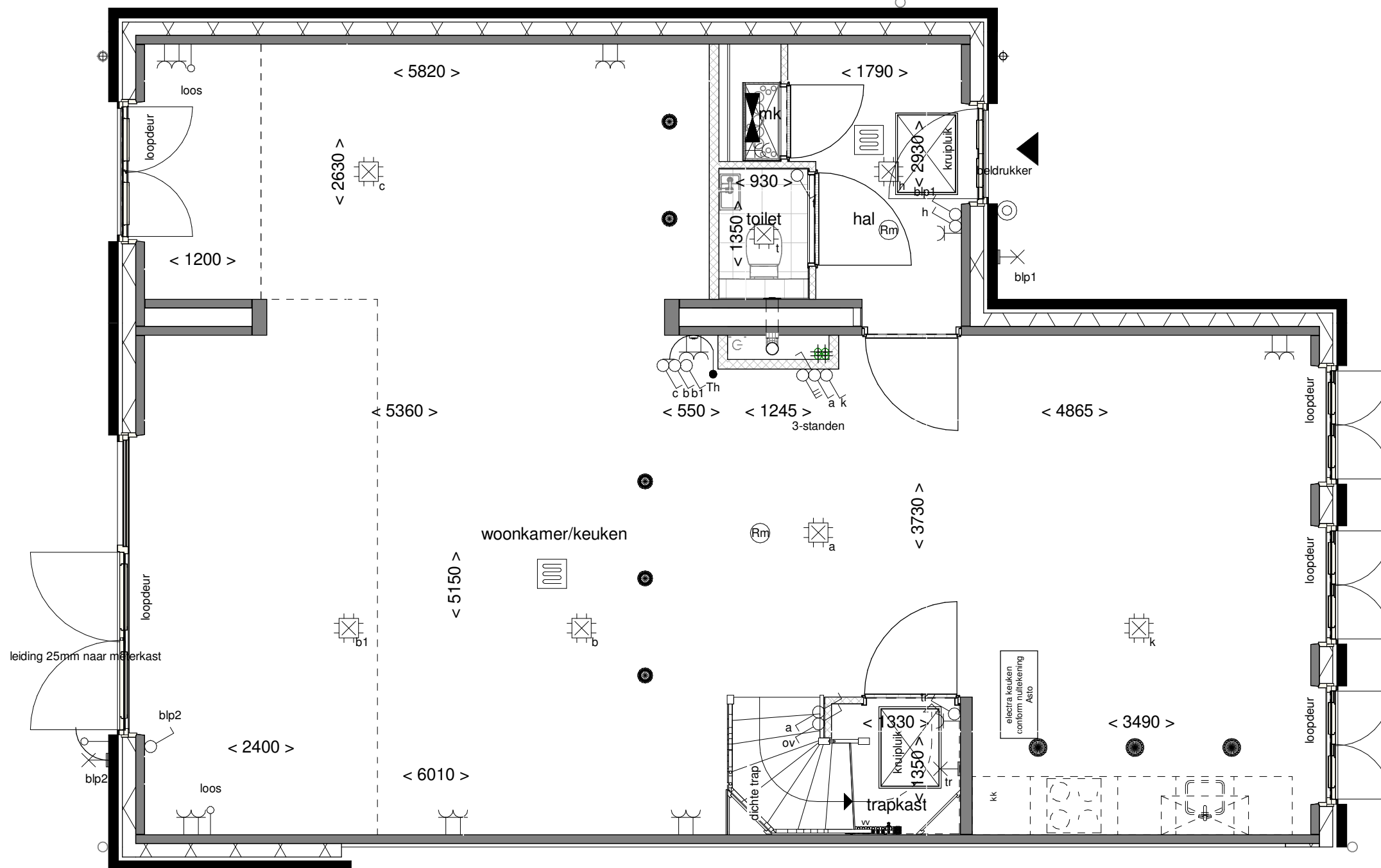

Achtergevel schaal 1:100

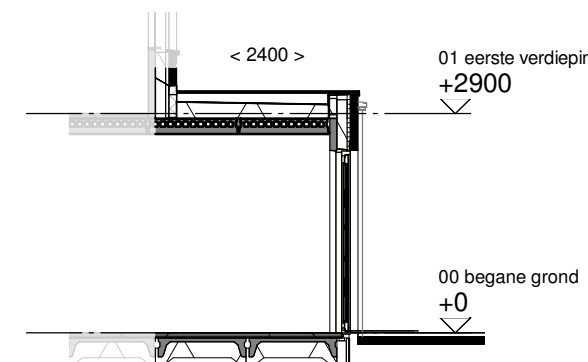

Doorsnede schaal 1:100

**ALLEMAAL
YIELEYAAL**

Optie: Uitb. achter 2400mm
+ zijuitbouw 1200mm

Woningtype: X54U

Bouwnummer: -

Optienummer: 1.A.X.52B

Schaal: 1:50 / 1:100

Datum: 29-09-2021

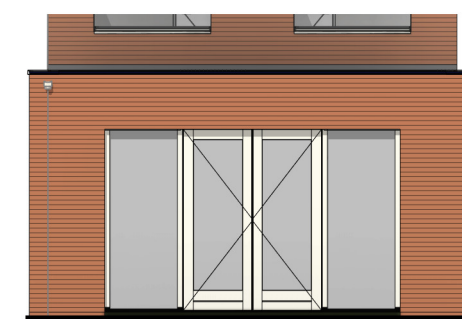
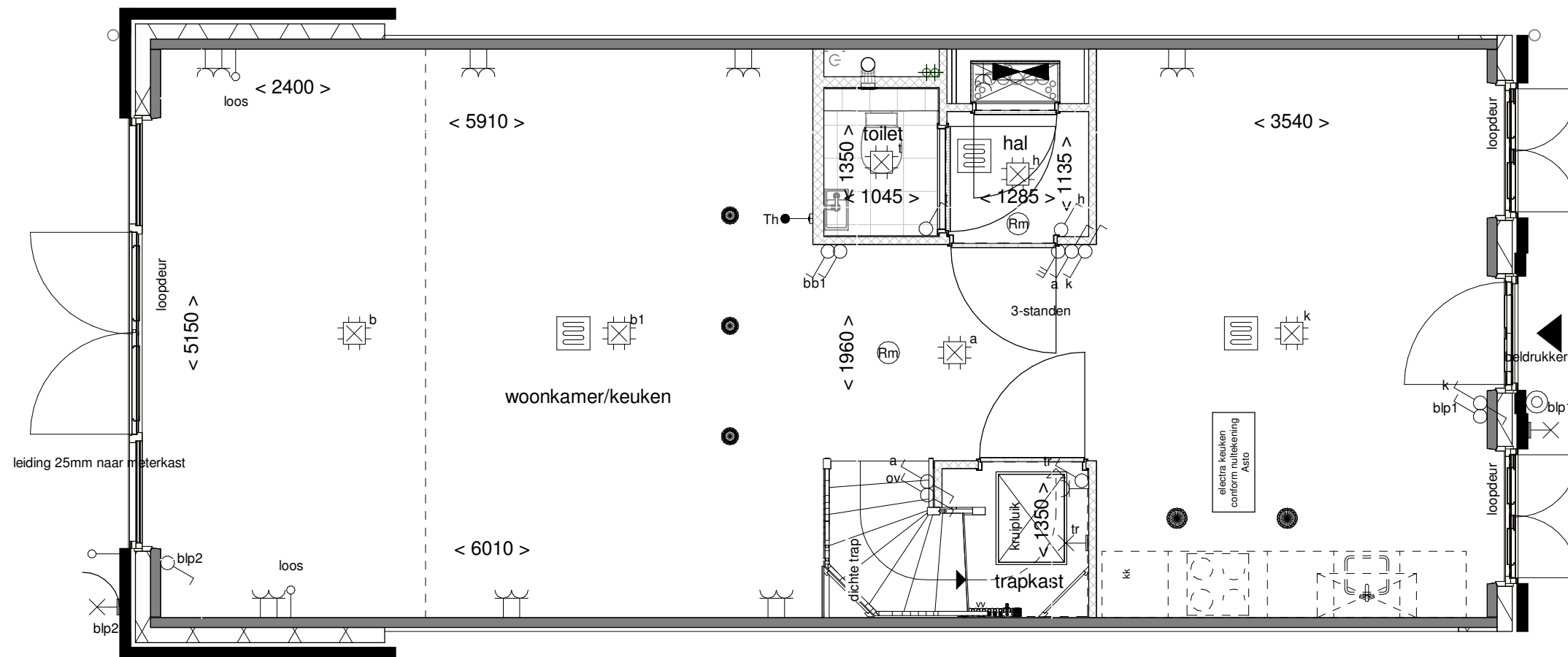

Achtergevel schaal 1:100

**ALLEMAAL
YIELEYAAL**

Optie: Dubbele deuren
achtergevel 3900mm

Woningtype: X54

Bouwnummer: -

Optienummer: 1.A.X.62

Schaal: 1:50 / 1:100

Datum: 29-09-2021

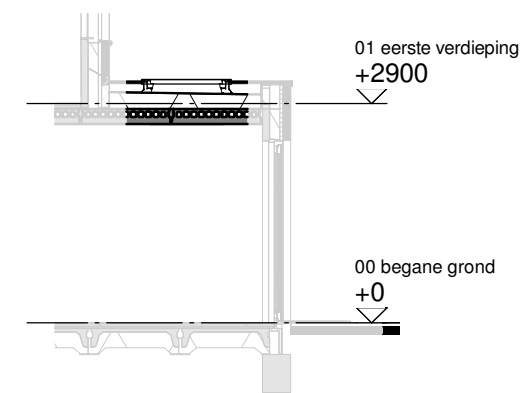
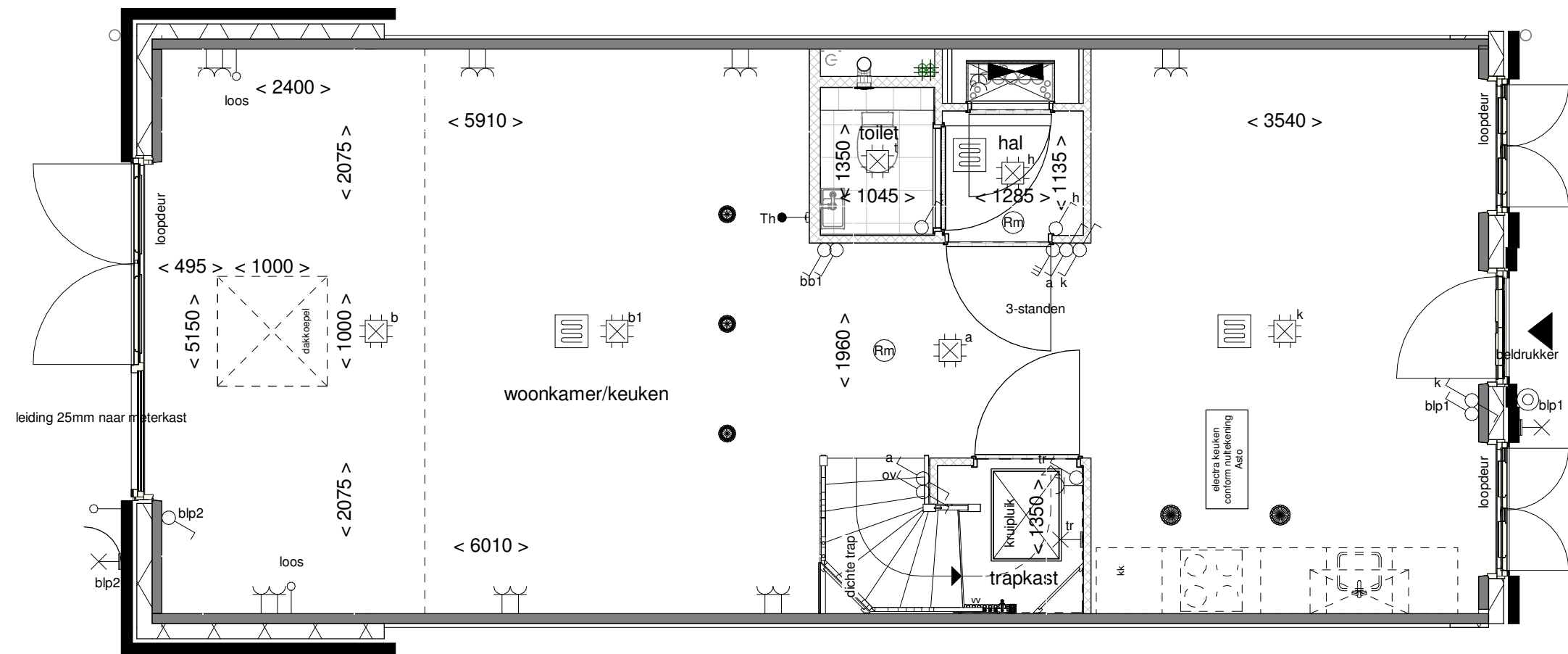

Doorsnede schaal 1:100

**ALLEMAAL
VIELEJAAL**

Optie: Lichtkoepel in
uitbouw 2400mm

Woningtype: X54

Bouwnummer: -

Optienummer: 1.B.X.10

Schaal: 1:50 / 1:100

Datum: 29-09-2021

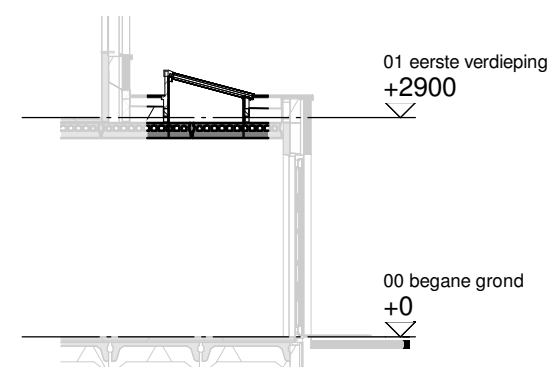
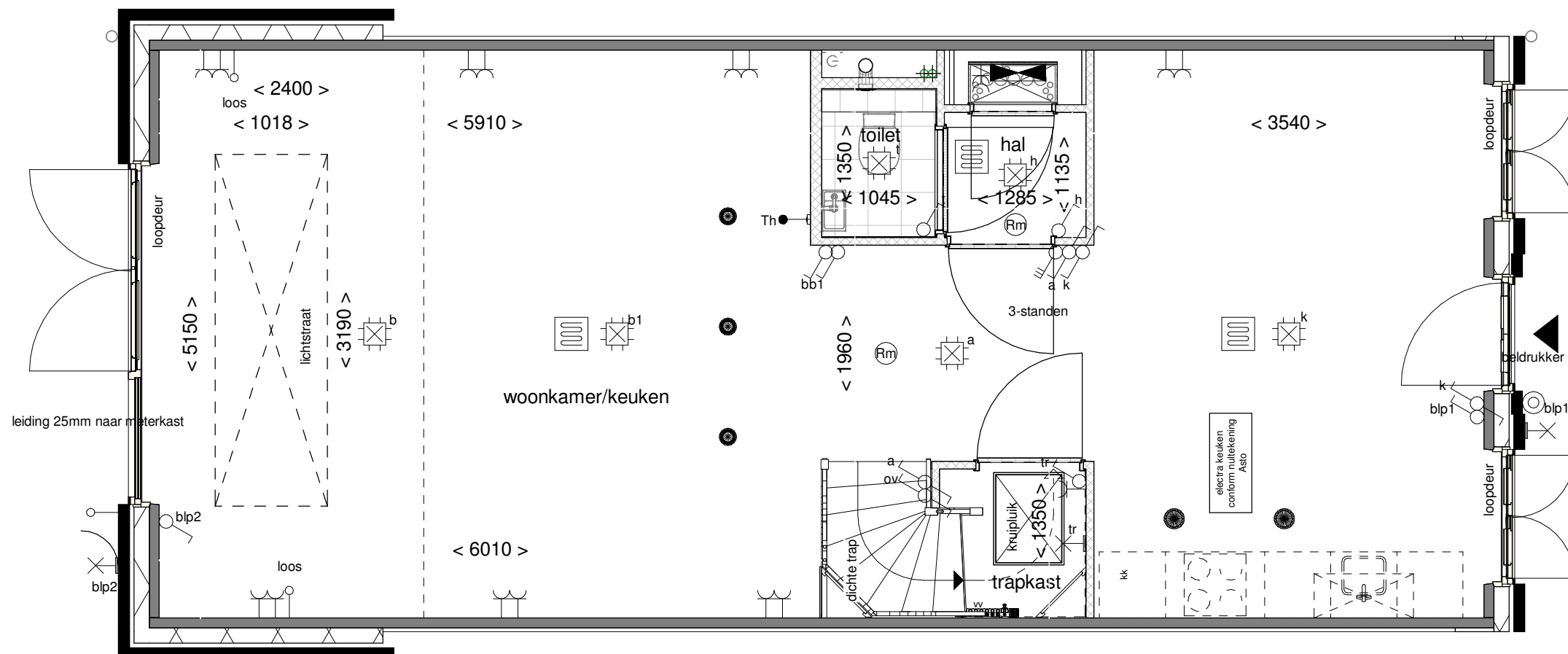

Doorsnede schaal 1:100

**ALLEMAAL
YIELEYAAL**

Optie: Lichtstraat in uitbouw
2400mm

Woningtype: X54

Bouwnummer: -

Optienummer: 1.B.X.14

Schaal: 1:50 / 1:100

Datum: 29-09-2021

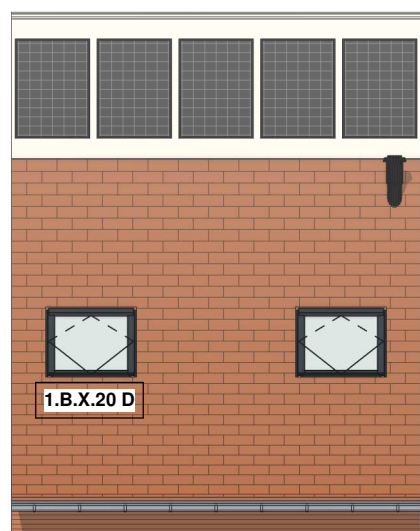
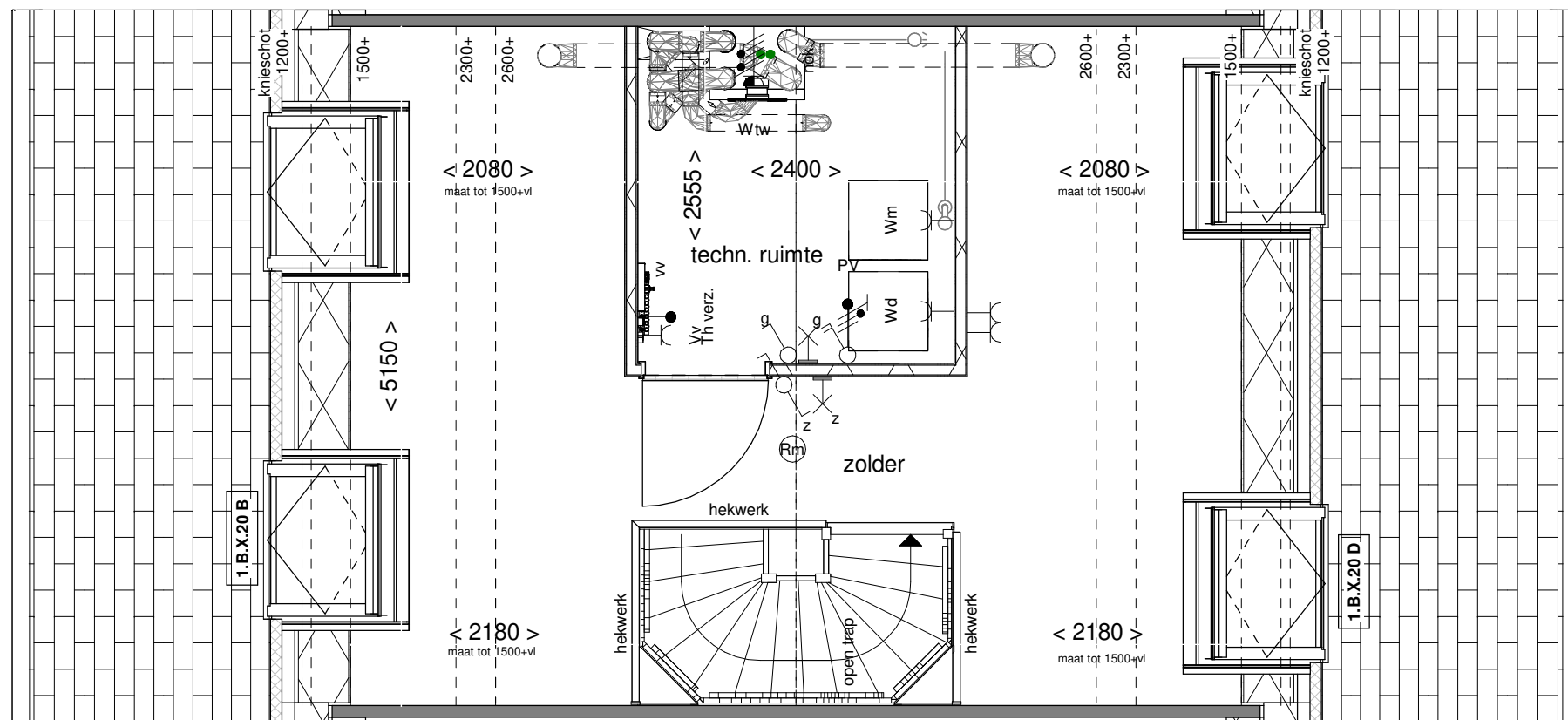

Voorgevel schaal 1:100

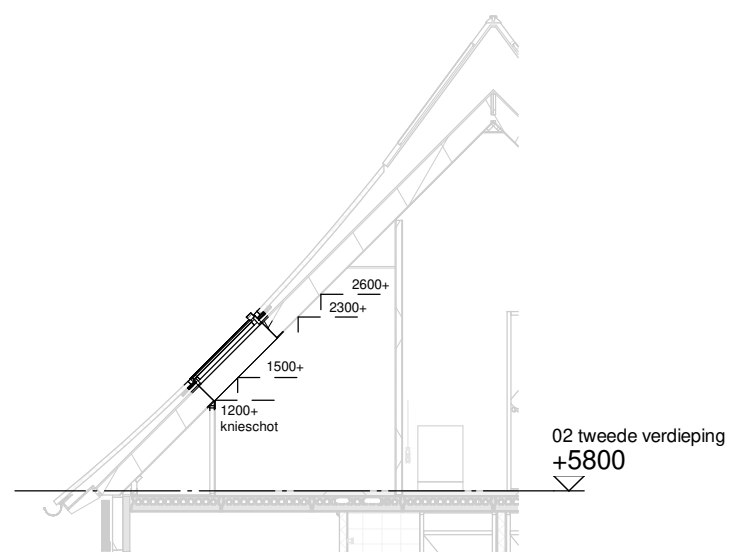

Doorsnede schaal 1:100

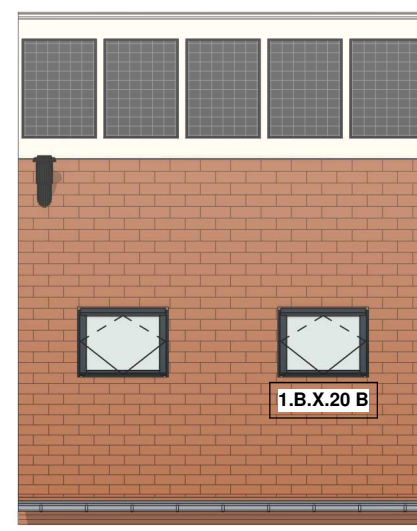

Achtergevel schaal 1:100

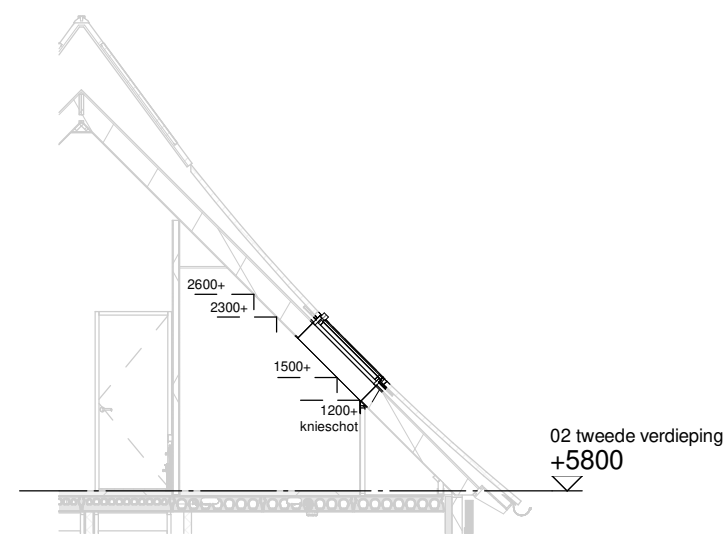

Doorsnede schaal 1:100

**ALLEMAAL
YIELEYAAL**

Optie: Dakramen voor- en achtergevel

Woningtype: X54

Bouwnummer: -

Optienummer: 1.B.X.20

Schaal: 1:50 / 1:100

Datum: 29-09-2021

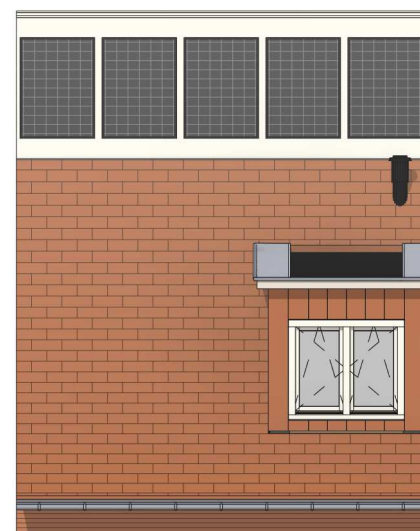
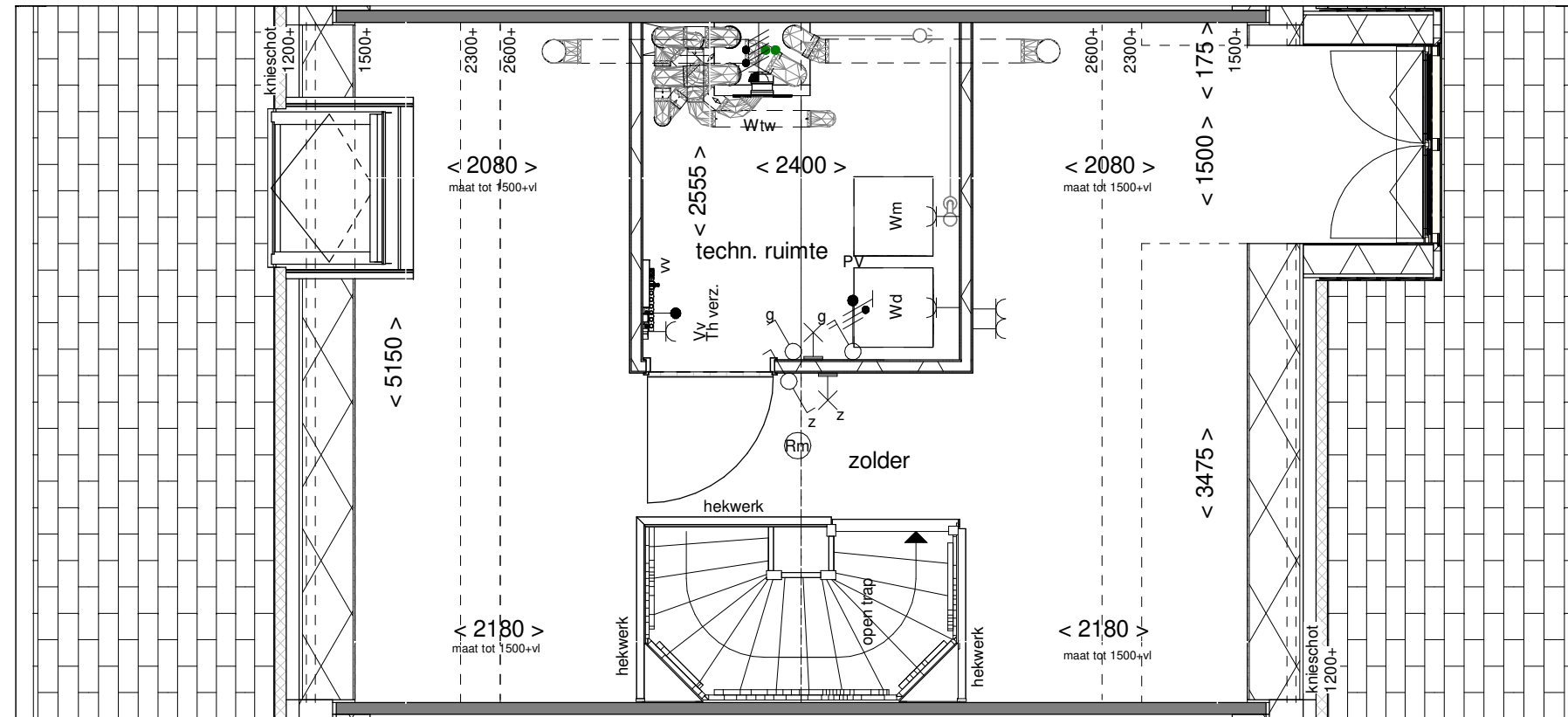

Achtergevel schaal 1:100

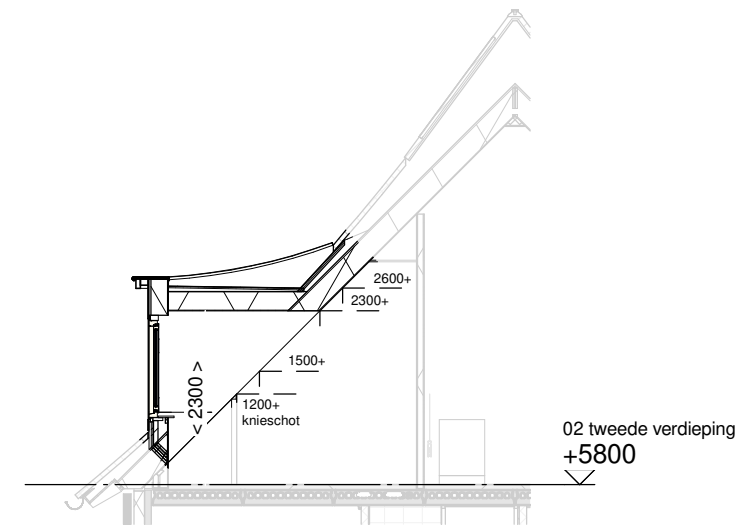

Doorsnede schaal 1:100

**ALLEMAAL
VIELEVAAL**

Optie: Dakkapel
voorgevel 1500mm

Woningtype: X54

Bouwnummer: -

Optienummer: 1.B.X.33

Schaal: 1:50 / 1:100

Datum: 29-09-2021

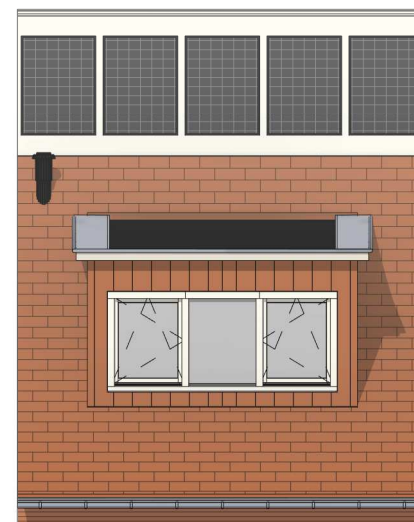
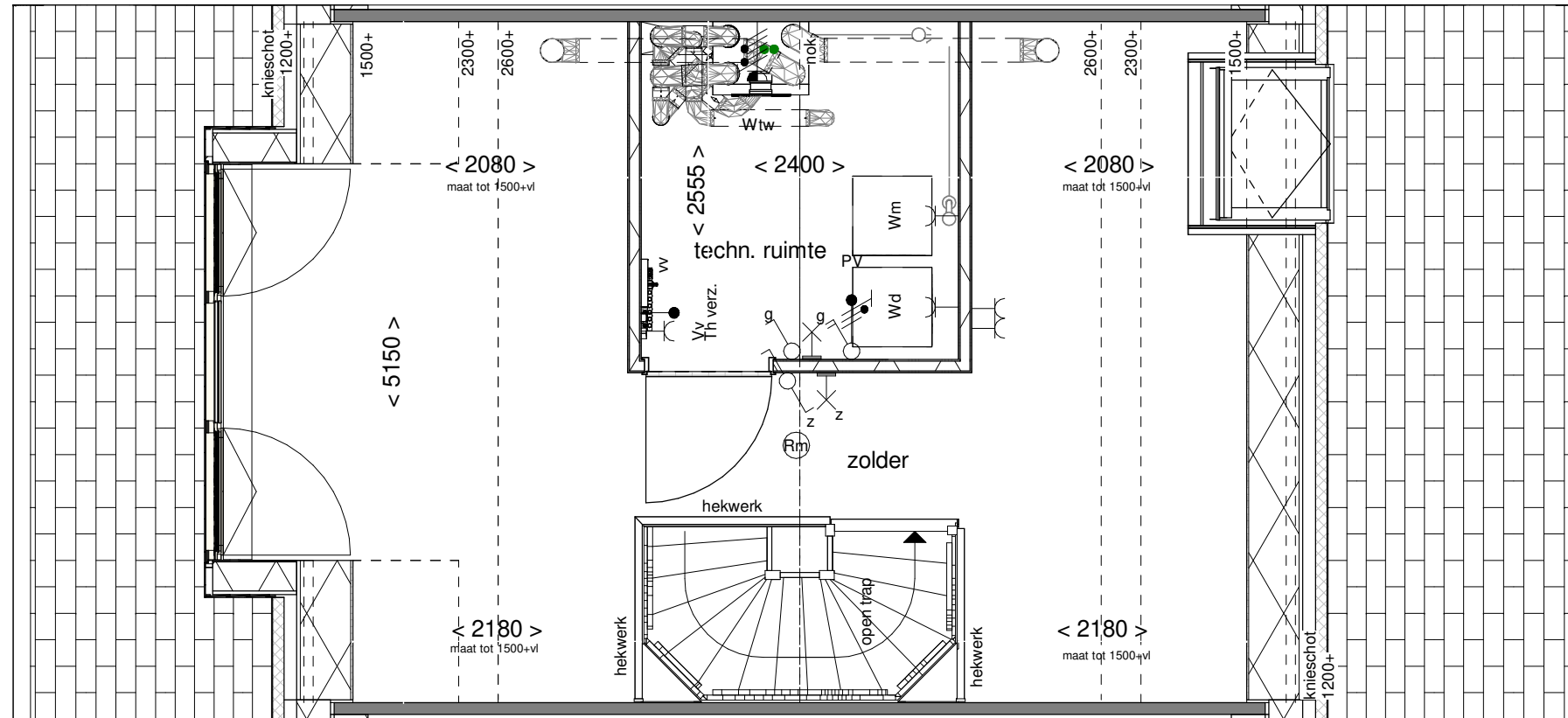

Achtergevel schaal 1:100

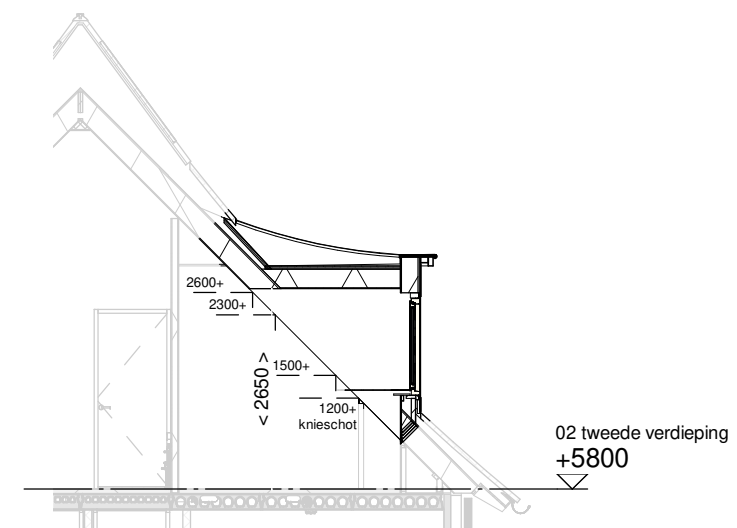

Doorsnede schaal 1:100

**ALLEMAAL
YIELEYAAL**

Optie: Dakkapel
achtergevel 3000mm

Woningtype: X54

Bouwnummer: -

Optienummer: 1.B.X.34

Schaal: 1:50 / 1:100

Datum: 29-09-2021

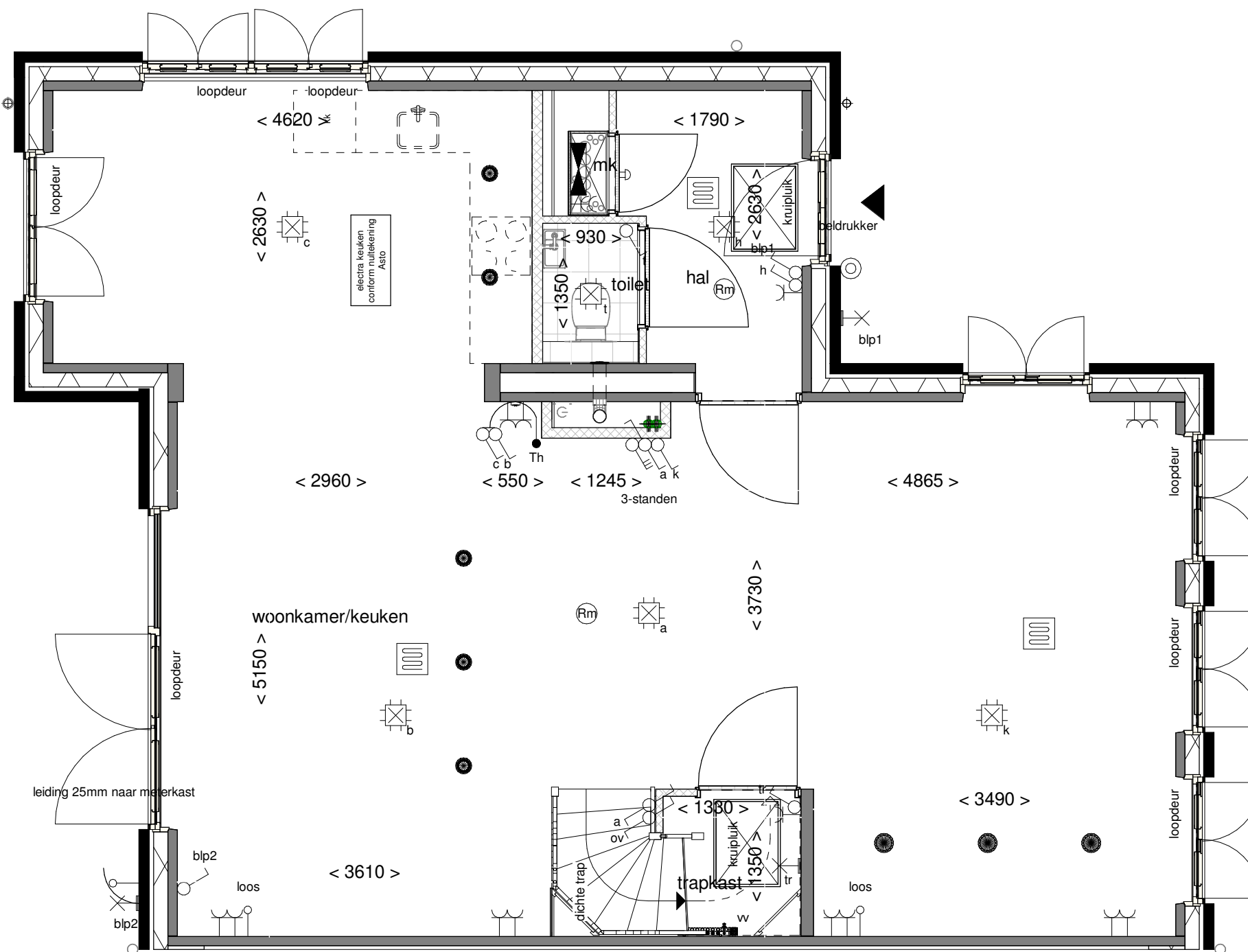

**ALLEMAAL
VIELEVAAL**

Optie: Keuken in zij-uitbouw

Woningtype: X54U

Bouwnummer: -

Optienummer: 1.C.X.12

Schaal: 1:50

Datum: 29-09-2021

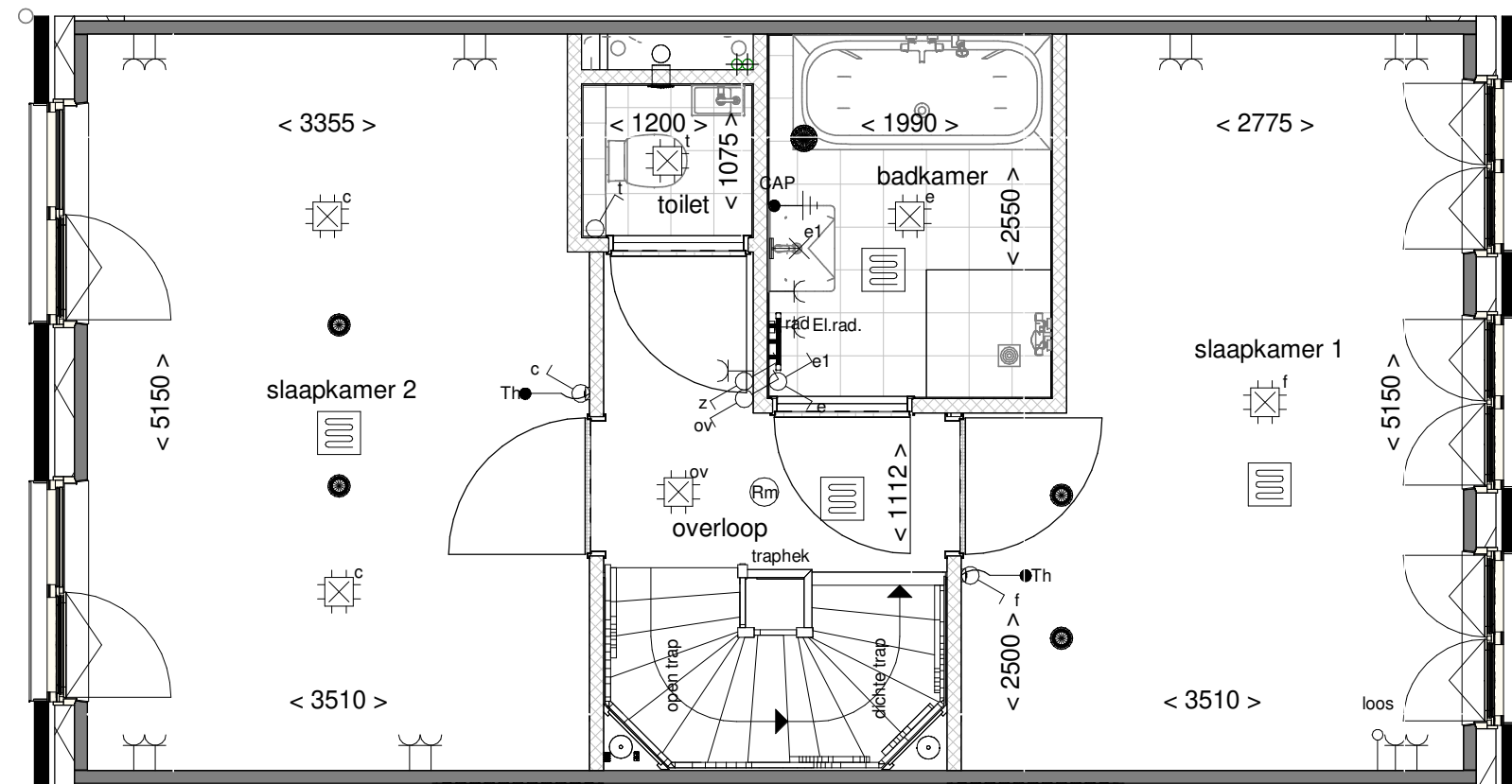

**ALLEMAAL
VIELEJAAR**

Optie: Samenvoegen
slaapkamer 2 en 3

Woningtype: X54

Bouwnummer: -

Optienummer: 1.C.X.30

Schaal: 1:50

Datum: 29-09-2021

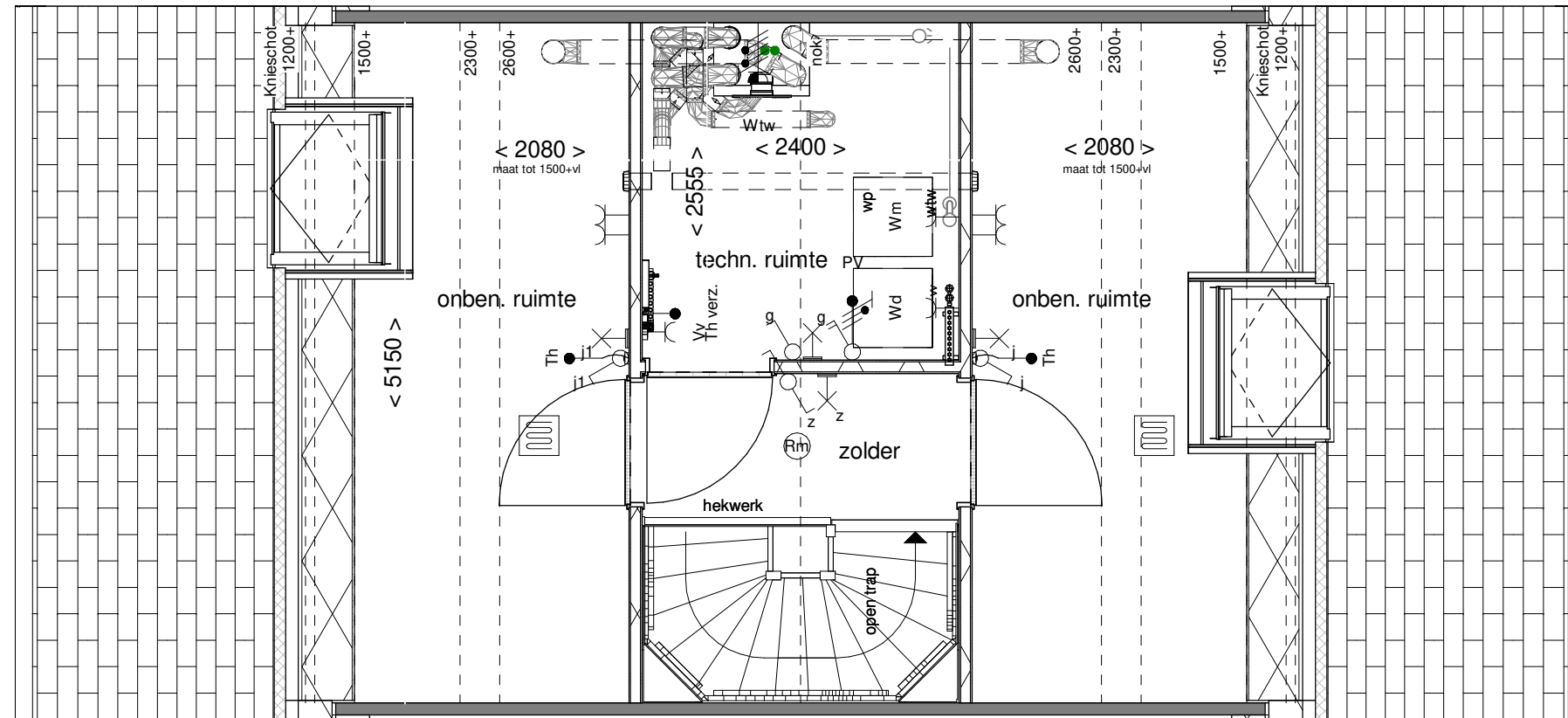

**ALLEMAAL
VIELEJAAL**

Optie: Indeling techn.- en 2
onb. ruimtes

Woningtype: X54

Bouwnummer: -

Optienummer: 1.C.X.76

Schaal: 1:50

Datum: 29-09-2021

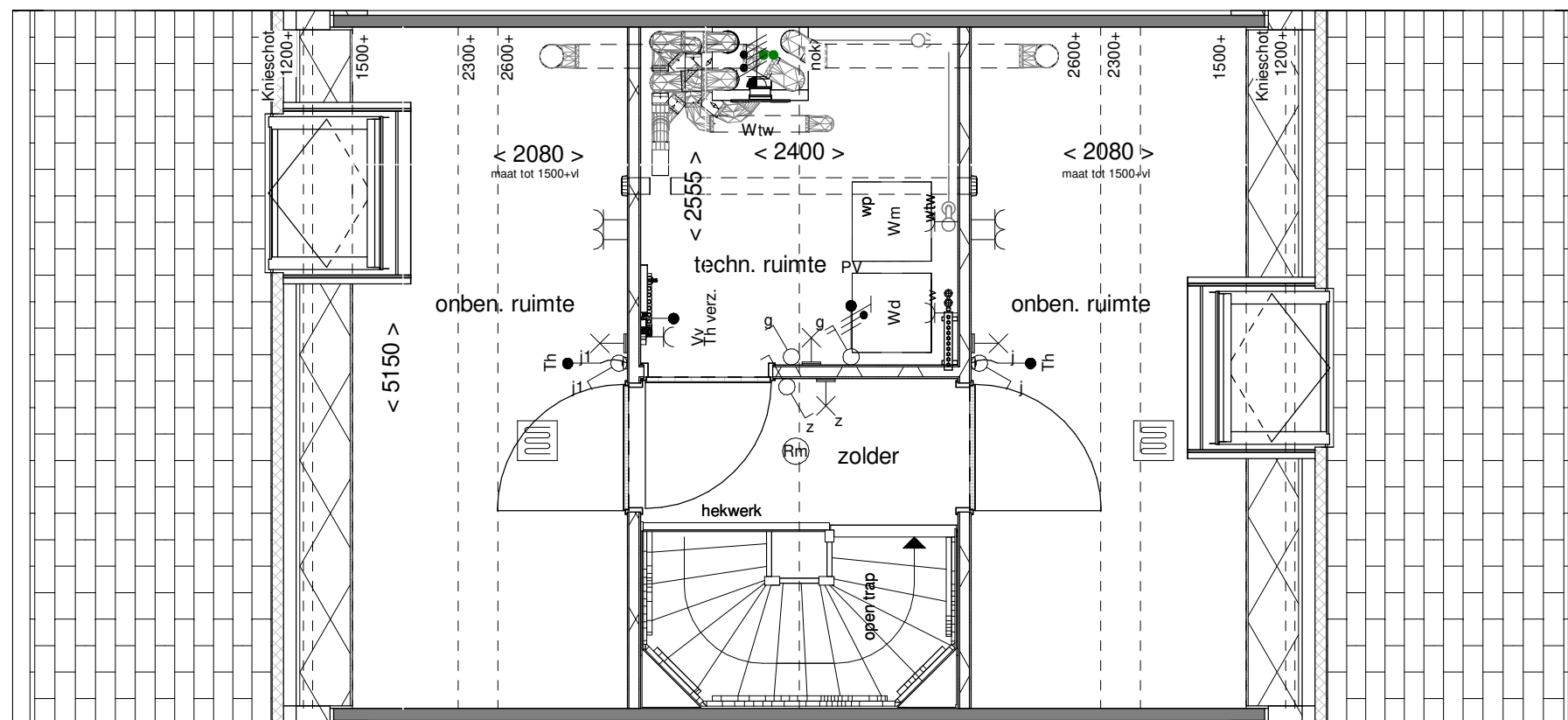

**ALLEMAAL
YIELEYAAL**

Optie: Indeling techn.- en 2
onb. ruimtes

Woningtype: X54

Bouwnummer: -

Optienummer: 1.C.X.78

Schaal: 1:50

Datum: 29-09-2021