

**ALLEMAAL  
YIELEYAAL**

Tekening: **Situatie totaal**

Woningtype:

Bouwnummer:

Bladnummer: **VT-S-01**

Schaal: **1:1000**

Datum: **27-10-2021**

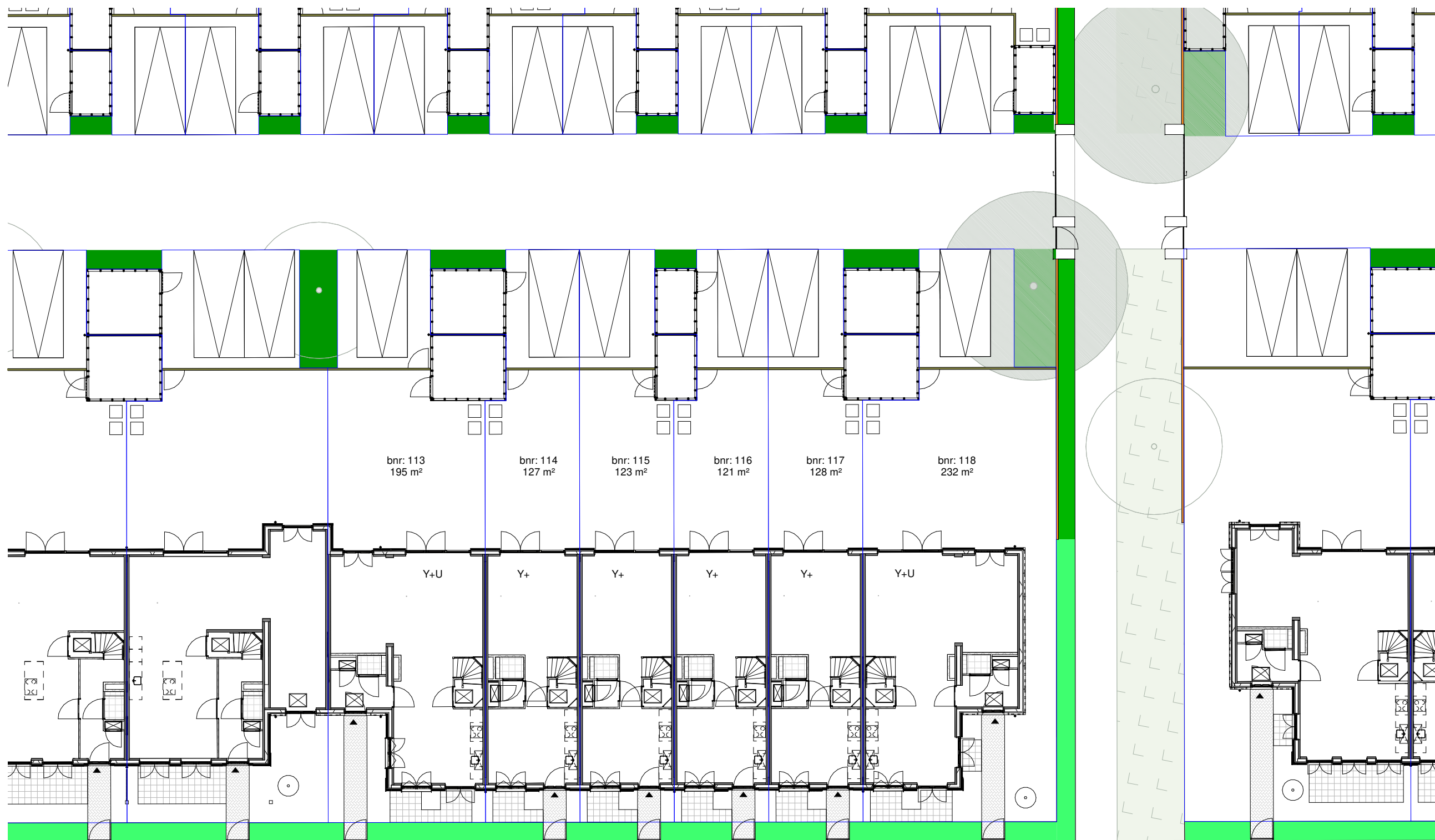

### Renvooi

-  - entree woning
-  - parkeervak eigen terrein
-  - erfgrans
-  - beplanting  
type n.t.b. koper
-  - opstelplaats klike
-  - tuinhekje
-  - klinkerbestrating
-  - betontegels  
300x300mm
-  - groen strook
-  - haag h=900mm
-  - haag h=1800mm
-  - bamboehok h=1800mm
-  - gaashek met klimplanten  
en poort h=1600mm

parkeerplekken en posities  
bomen en struiken zijn indicatief



Warmoldstraat

**ALLEMAAL  
YIELEYAAL**

Tekening: Situatie Blok D4

Woningtype: Y+U, Y+

Bouwnummer: 113-118











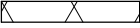

Bladnummer: VT-S-10

Schaal: 1:200



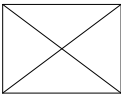

























Datum: 27-10-2021



## Renvooi bouwkundig

	metselwerk kleur A
	dakpannen kleur oranje
	entree woning
	metselwerk
	isolatie
	dragende wand
	niet dragende binnenwand
	binnendeurkozijn (met bovenlicht)
	kruipluik
	opstelplaats wasmachine
	opstelplaats wasdroger
	
	principe opstelling keukenblok

## Renvooi installaties

	aansluitpunt licht
	aansluitpunt licht, wand
	centraaldoos met lichtpunt
	armatuur aan de wand
	rookmelder
	aansluitpunt niet bedraad
	verdeelinrichting / meterkast / groepenkast
	beldrukker
	schel
	schakelaar, 1-polig
	werkschakelaar tbv PV-panelen
	schakelaar, 3-polig
	schakelaar, wissel
	schakelaar, kruis
	schakelaar, serie
	wandcontactdoos 1-voudig met beschermingscontact
	wandcontactdoos 2-voudig met beschermingscontact, verticaal
	wandcontactdoos 2-voudig met beschermingscontact
	thermostaatleiding, bedraad
	mechanische ventilatie-unit incl. warmteterugwinunit
	warmtepomp
	inblaasventiel mechanische ventilatie
	uitblaasventiel mechanische ventilatie
	verdeler vloerverwarming
	ruimte voorzien van vloerverwarming
	elektrische radiator
	kanalen in het zicht
	onbenoemde ruimte volgens krijstreepmethode

### Disclaimer

De op deze tekeningen aangegeven maten zijn circa maten in millimeters en tussen de wanden / vloeren gemeten, waarbij geen rekening is gehouden met enige wandafwerking, plinten, aftimmering, ect. In verband met de nauwkeurige uitwerking van details, constructie, maatvoering, materialen e.d. kunnen er kleine afwijkingen ontstaan ten opzichte van de nu vermelde gegevens. Deze geringe afwijkingen geven geen aanleiding tot verrekening. Aan de op deze tekening aangegeven maten kunnen derhalve geen rechten worden ontleend. De op deze tekeningen aangegeven maatvoering is niet geschikt voor opdrachten aan derden door koper(s). De posities van aansluitingen en installatie onderdelen zijn indicatief op tekening aangegeven. De exacte aantallen en posities zullen na berekening in het werk door de installateurs worden bepaald en kunnen afwijken van deze tekening.

**ALLEMAAL  
YIELEYAAL**

Tekening: Renvooi

Woningtype: -

Bouwnummer: -

Bladnummer: VT-0-00c

Schaal: -

Datum: 27-10-2021



Type: Y+U  
bwnr: 113

Type: Y+  
bwnr: 114

Type: Y+  
bwnr: 115

Type: Y+  
bwnr: 116

Type: Y+  
bwnr: 117

Type: Y+U  
bwnr: 118



Type: Y+U  
bwnr: 118

Type: Y+  
bwnr: 117

Type: Y+  
bwnr: 116

Type: Y+  
bwnr: 115

Type: Y+  
bwnr: 114

Type: Y+U  
bwnr: 113

ALLEMAAL  
YIELEYAAL

Tekening: Gevels blok D4

Woningtype: Y+, Y+U

Bouwnummer: 113 t/m 118

Bladnummer: VT-D4-00a

Schaal: 1:150

Datum: 27-10-2021





Type: Y+U  
Bouwnummer: 113

Linker zijgevel



Type: Y+U  
Bouwnummer: 118

Rechter zijgevel

ALLEMAAL  
YIELEYAAL

Tekening: Zijgevels blok D4

Woningtype: Y, Y+U

Bouwnummer: 113 t/m 118

Bladnummer: VT-D4-00b

Schaal: 1:100

Datum: 27-10-2021

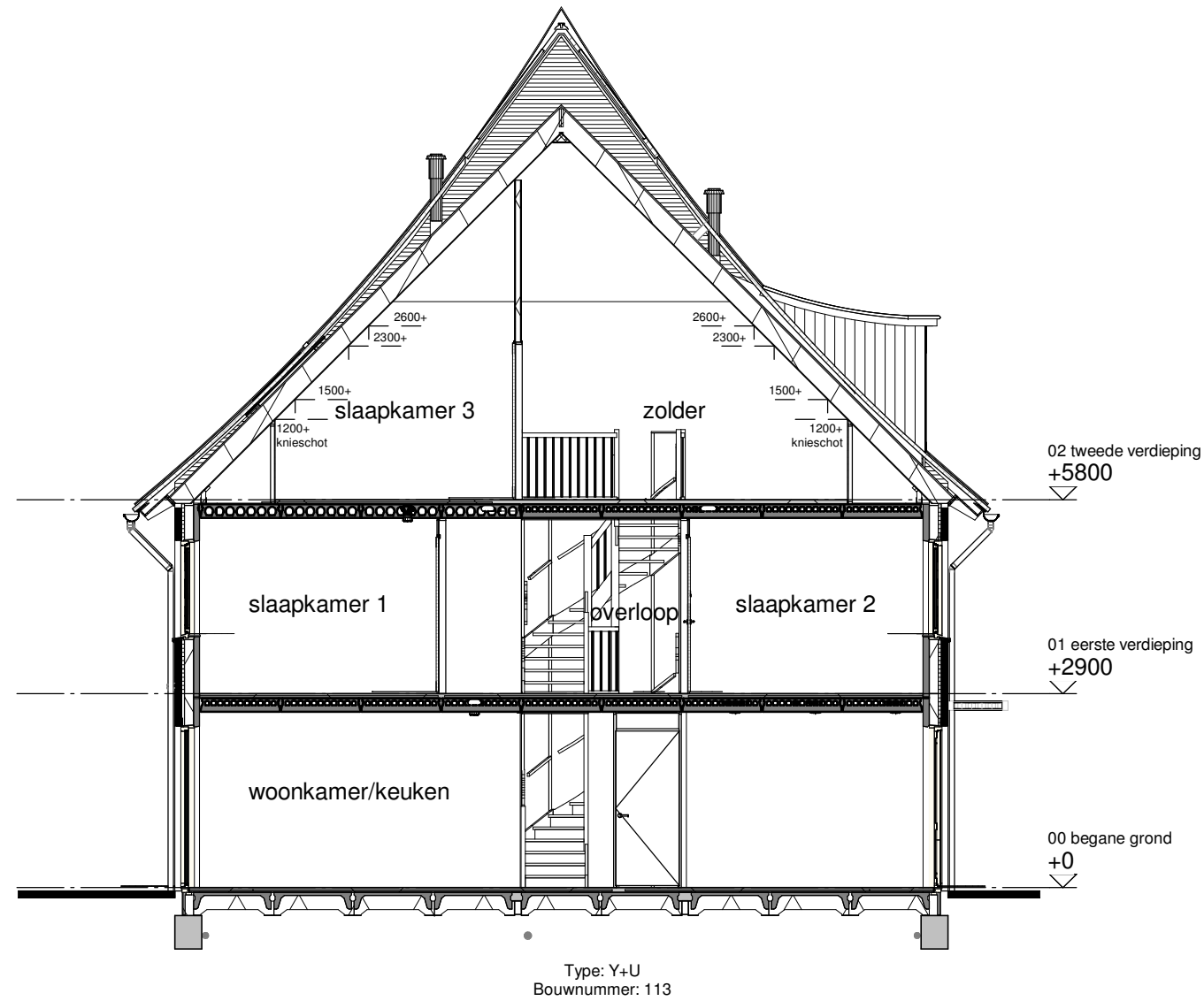

Doorsnede A

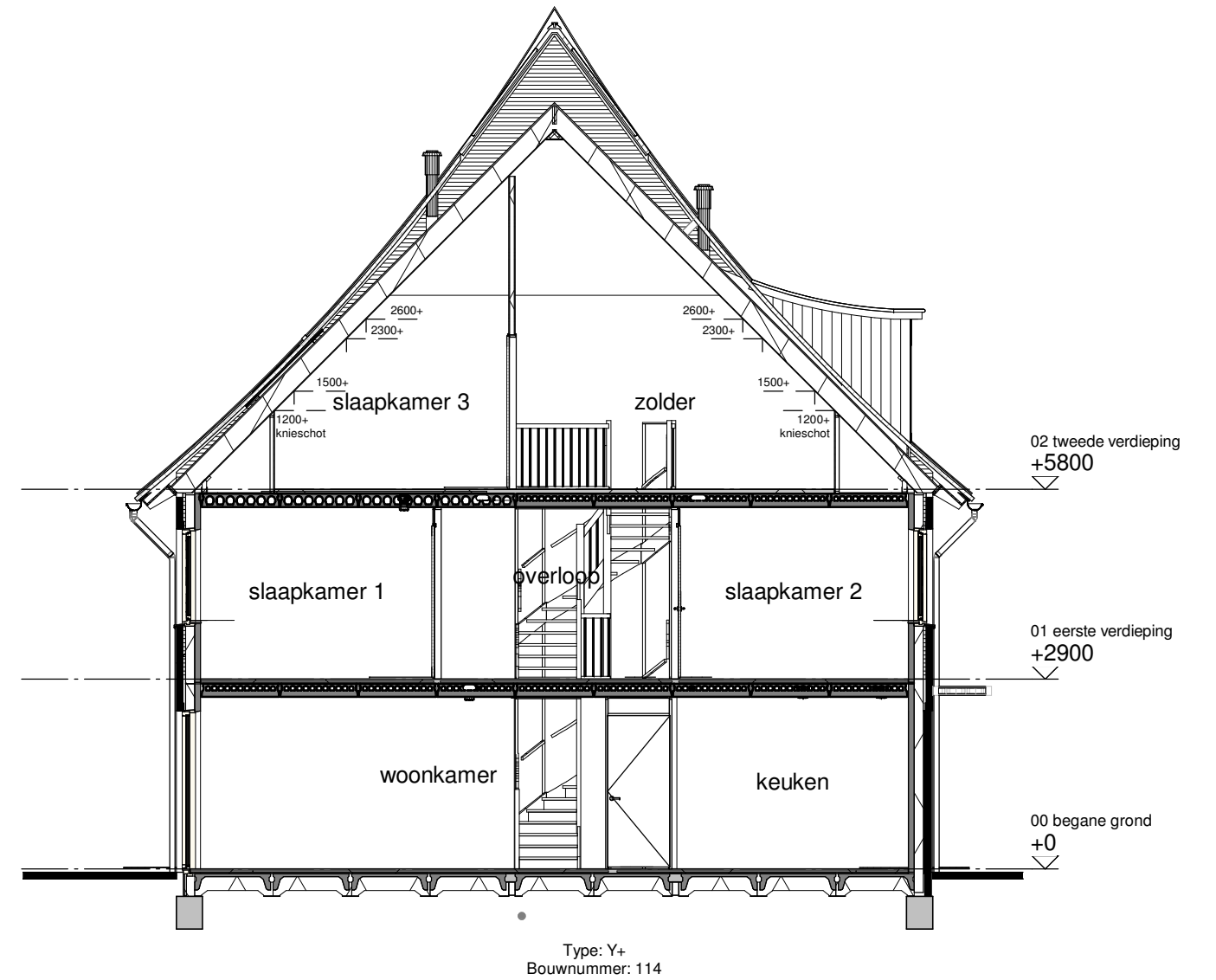

Doorsnede B

ALLEMAAL  
YIELEYAAL

Tekening: Doorsneden blok D4

Woningtype: Y+U, Y+

Bouwnummer: 113-118

Bladnummer: VT-D4-00c

Schaal: 1:100

Datum: 27-10-2021



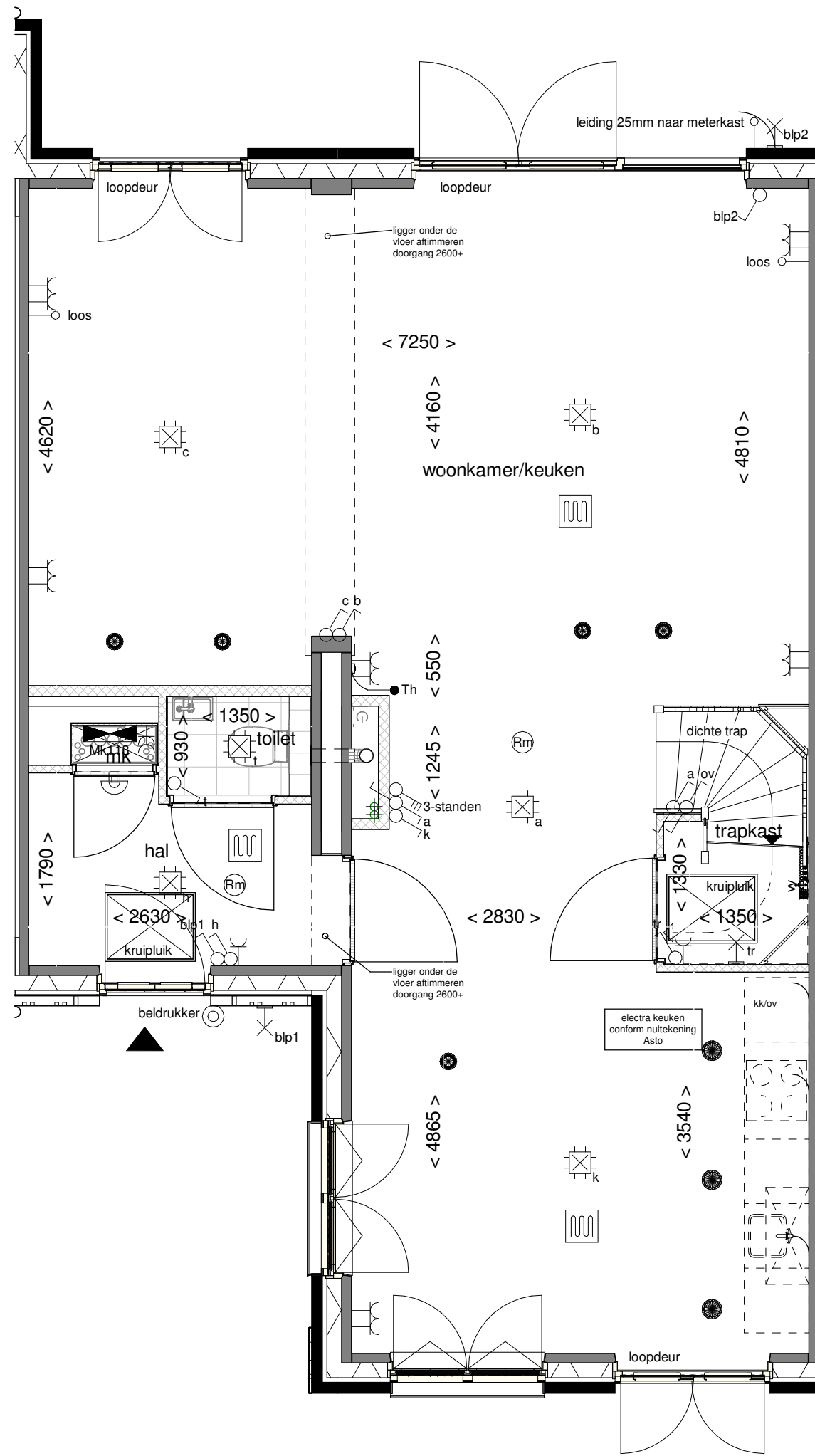

**ALLEMAAL  
YIELEYAAL**

Tekening: Begane grond  
 Woningtype: Y+U  
 Bouwnummer: 113  
 Bladnummer: VT-D4-113a  
 Schaal: 1:50  
 Datum: 27-10-2021

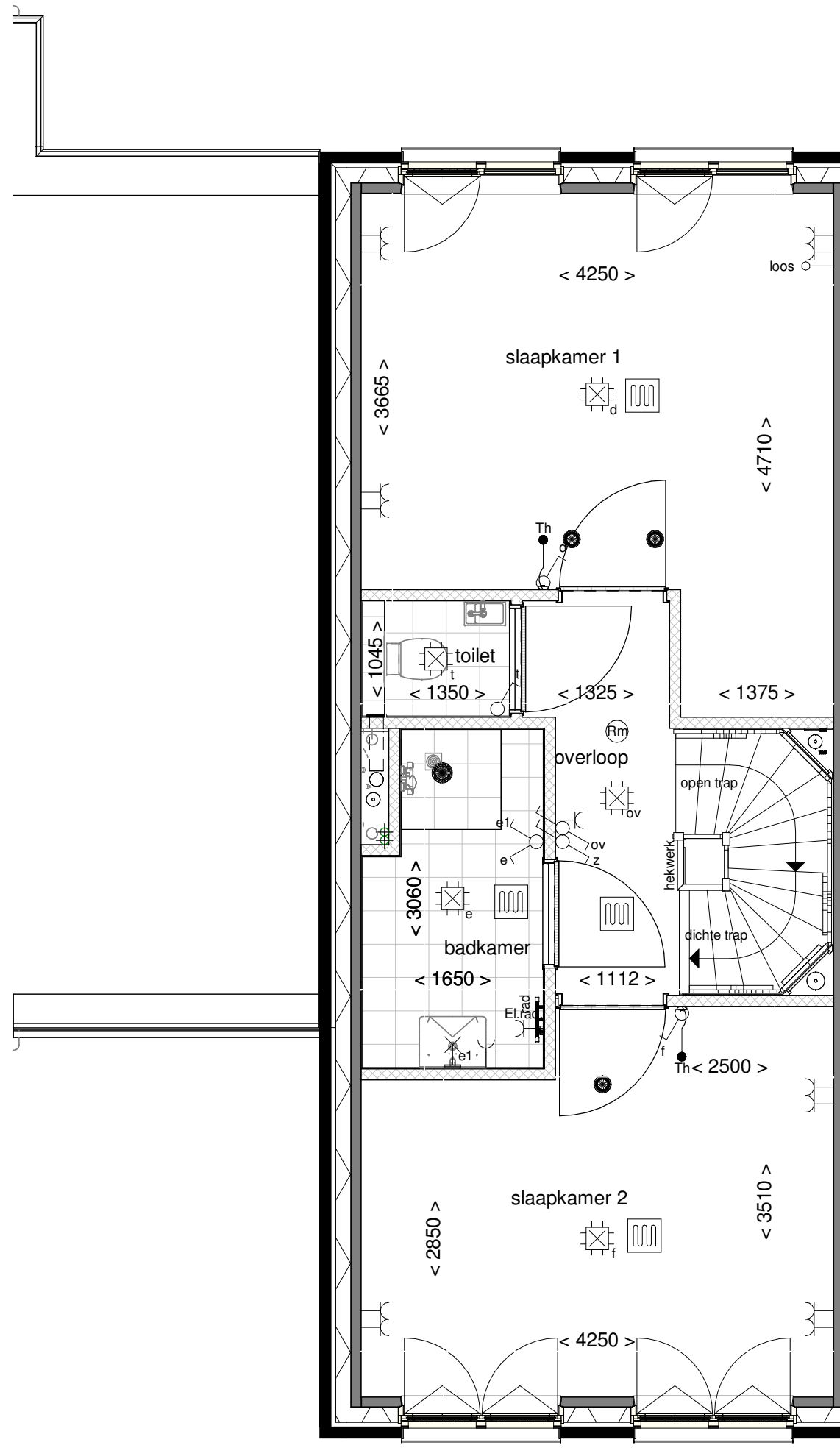

**ALLEMAAL  
YIELEYAAL**

Tekening: Eerste verdieping

Woningtype: Y+U

Bouwnummer: 113

Bladnummer: VT-D4-113b

Schaal: 1:50

Datum: 27-10-2021



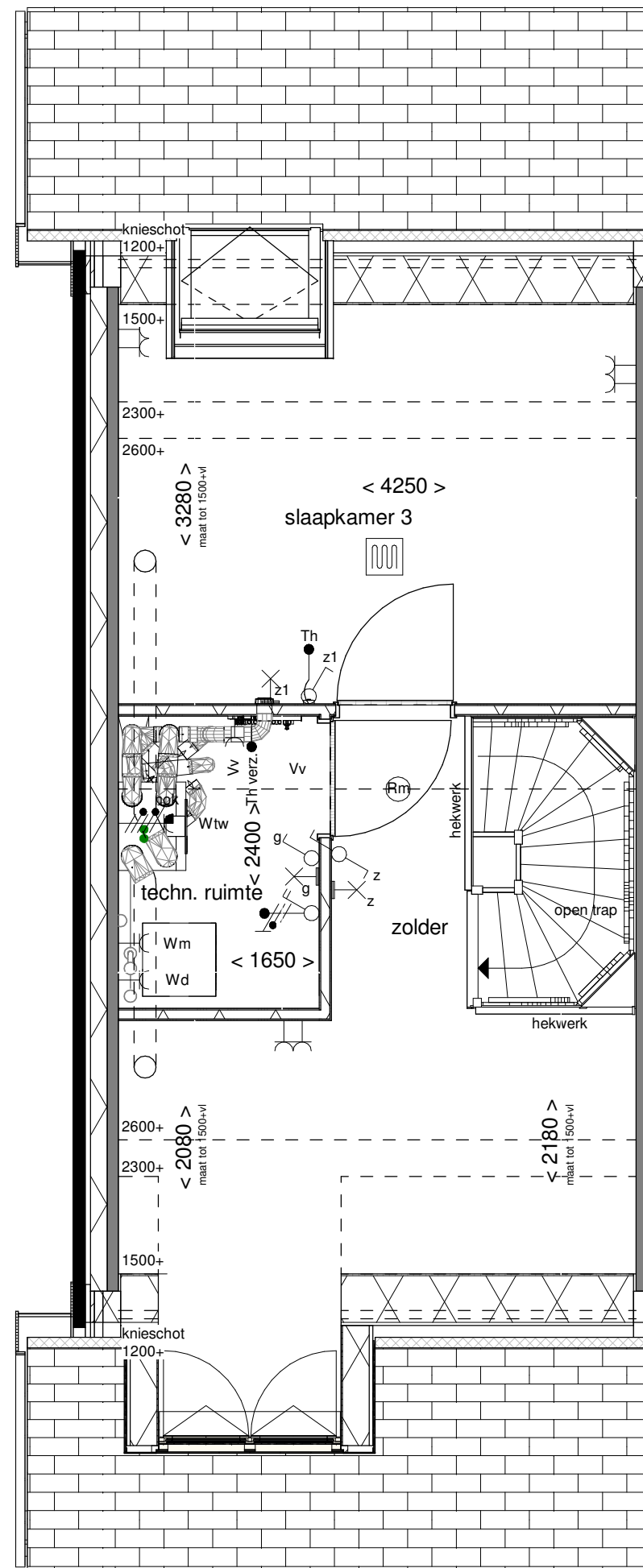

**ALLEMAAL  
YIELEYAAL**

Tekening: Tweede verdieping

Woningtype: Y+U

Bouwnummer: 113

Bladnummer: VT-D4-113c

Schaal: 1:50

Datum: 27-10-2021

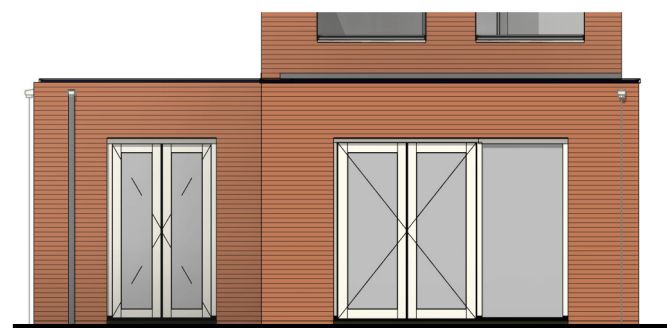
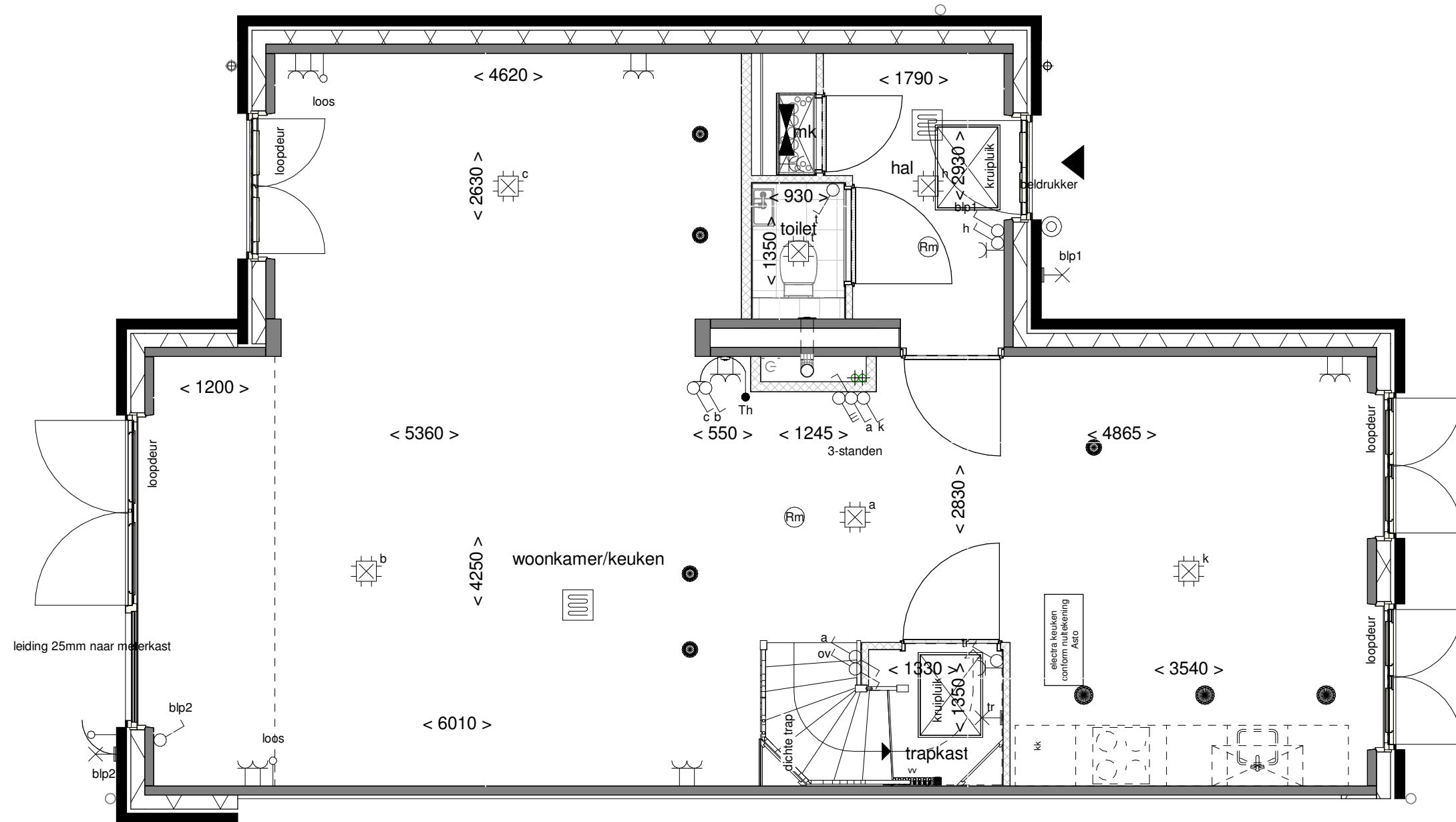

Achtergevel schaal 1:100

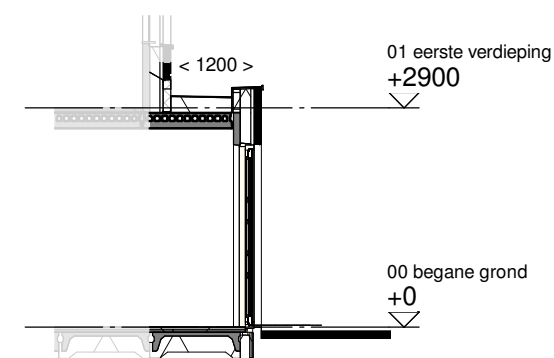

Doorsnede schaal 1:100

**ALLEMAAL  
YIELEYAAL**

Optie: **Uitbouw achtergevel  
1200mm**

Woningtype: **Y45+U**

Bouwnummer: -

Optienummer: **0.A.Y.14**

Schaal: **1:50 / 1:100**

Datum: **29-09-2021**



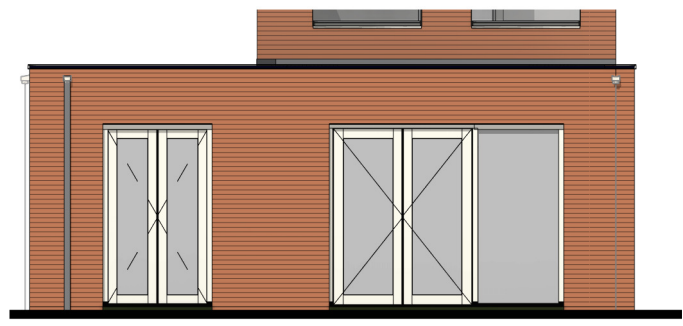
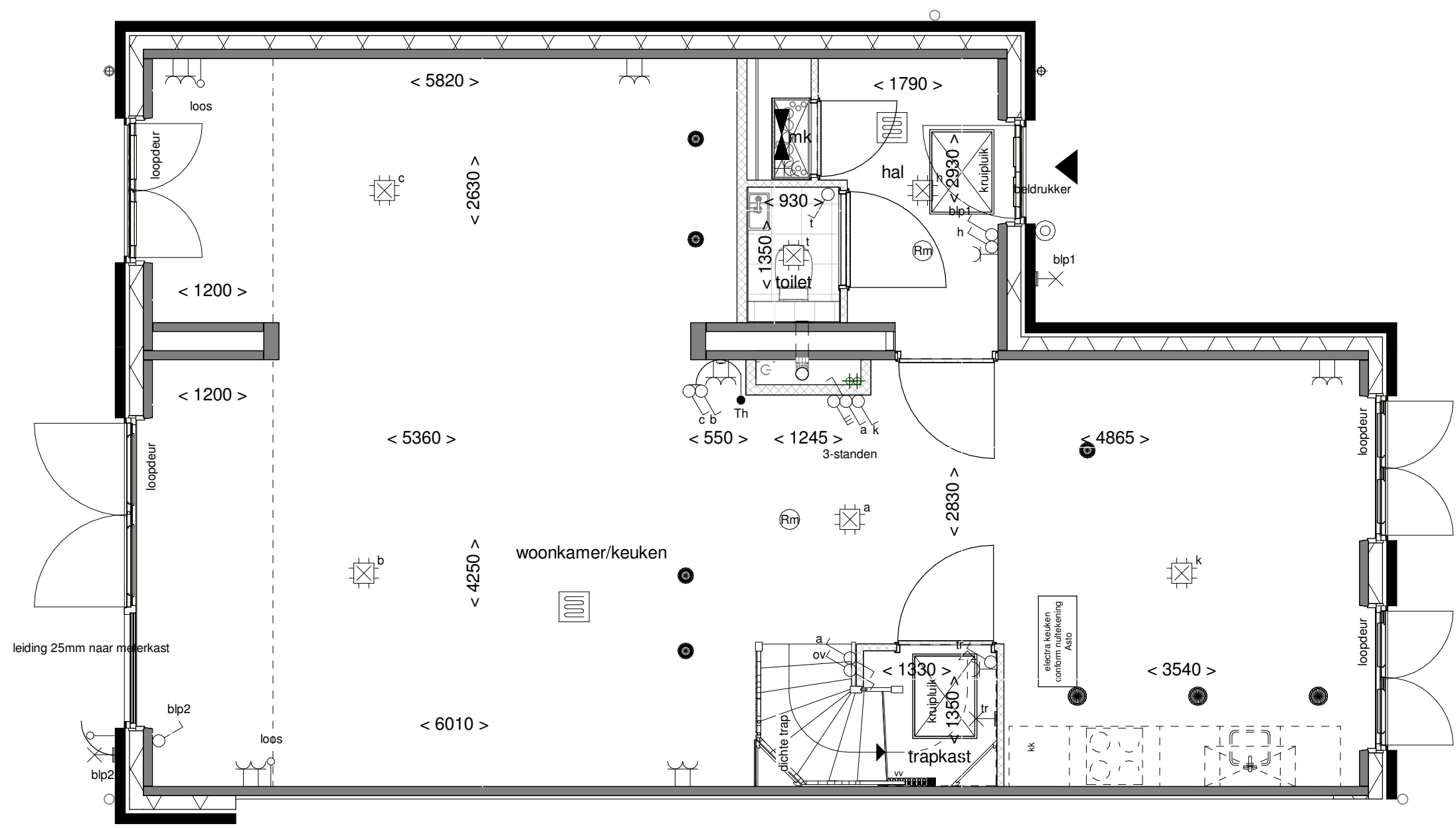

Achtergevel schaal 1:100

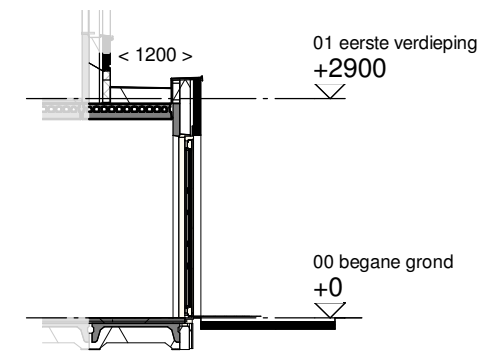

Doorsnede schaal 1:100

**ALLEMAAL  
YIELEYAAL**

Optie: **Uitbouw achtergevel + zijuitbouw**

---

Woningtype: **Y45+U**

---

Bouwnummer: -

---

Optienummer: **0.A.Y.52**

---

Schaal: **1:50 / 1:100**

---

Datum: **29-09-2021**

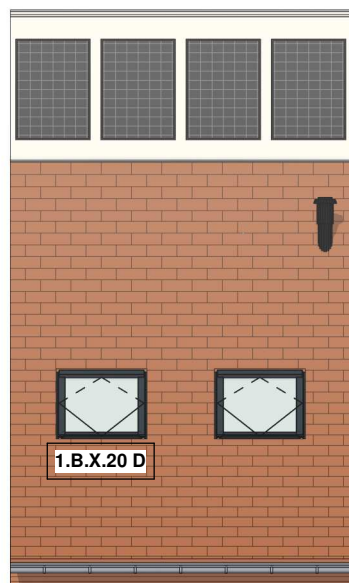
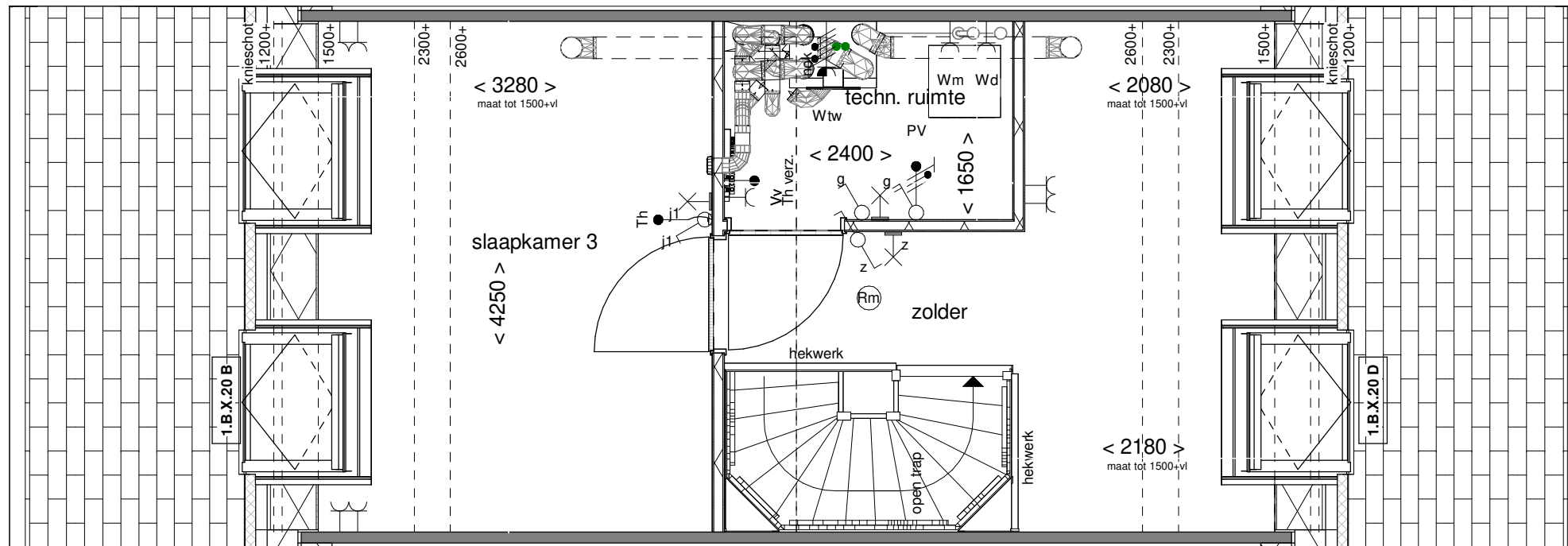

Voorgevel schaal 1:100

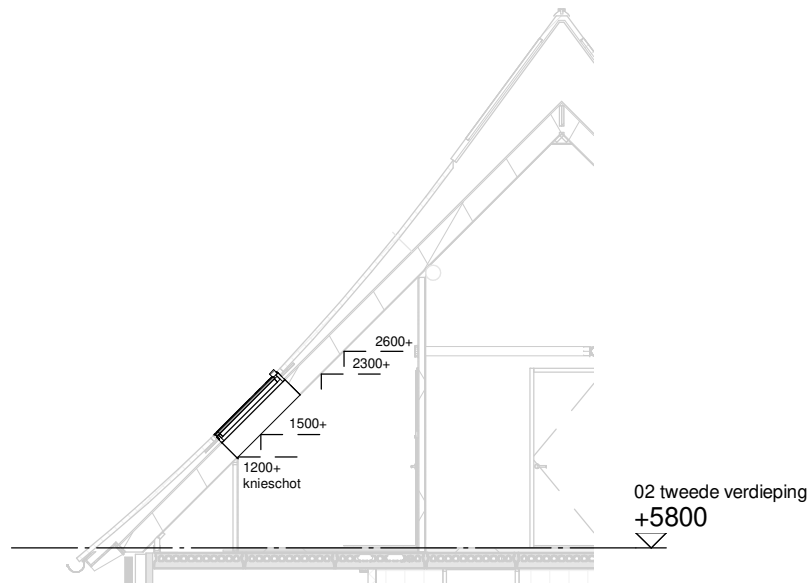

Doorsnede schaal 1:100

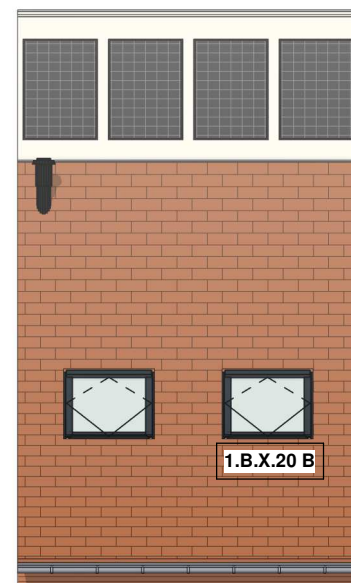

Achtergevel schaal 1:100

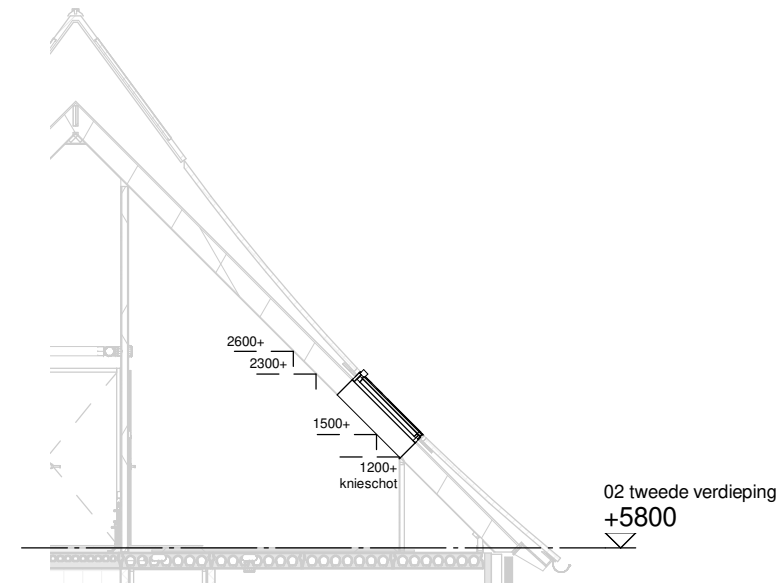

Doorsnede schaal 1:100

**ALLEMAAL  
YIELEYAAL**

Optie: Dakramen voor- en achtergevel

Woningtype: Y45+

Bouwnummer: -

Optienummer: 1.B.X.20

Schaal: 1:50 / 1:100

Datum: 29-09-2021

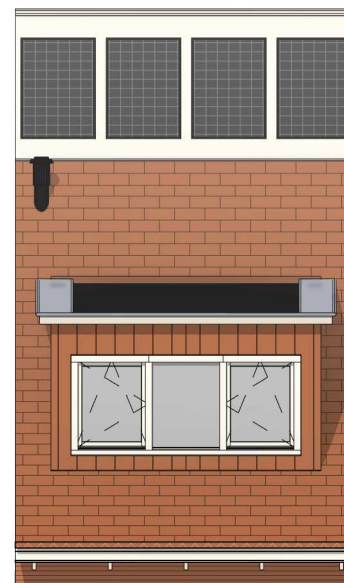
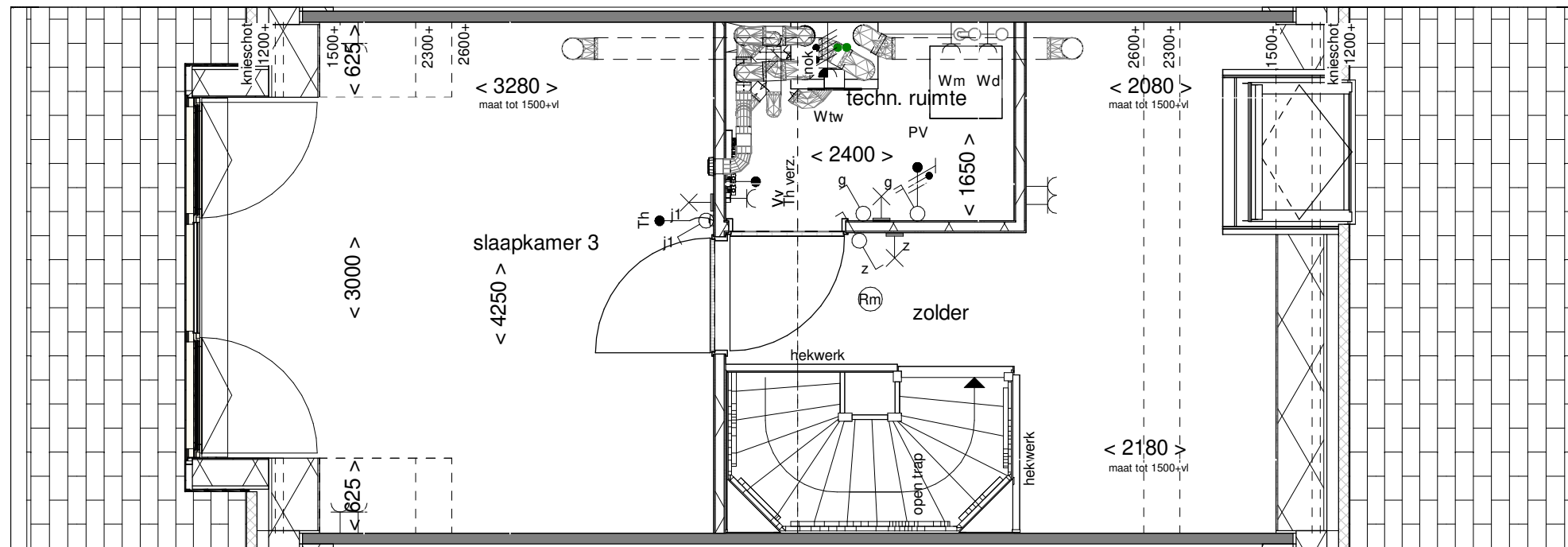

Achtergevel schaal 1:100

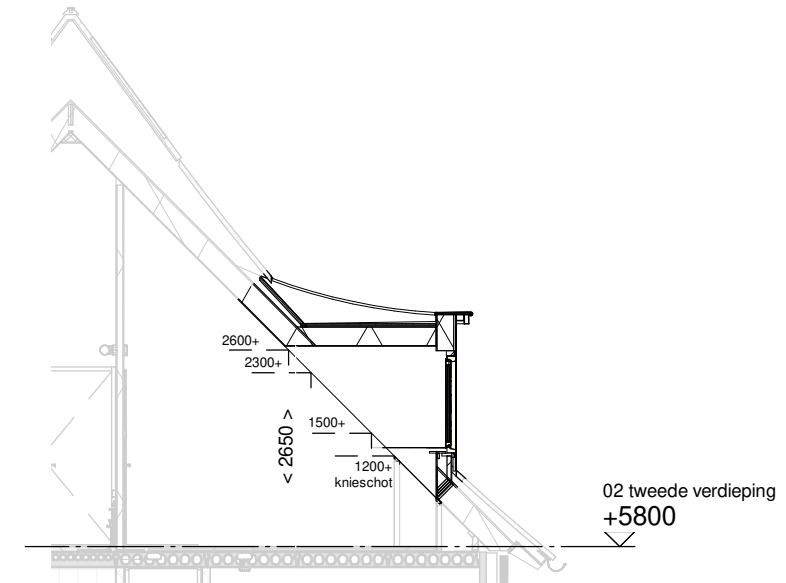

Doorsnede schaal 1:100

**ALLEMAAL  
YIELEYAAL**

Optie: Dakkapel  
achtergevel 3000mm

Woningtype: Y45+

Bouwnummer: -

Optienummer: 1.B.X.34

Schaal: 1:50 / 1:100

Datum: 29-09-2021

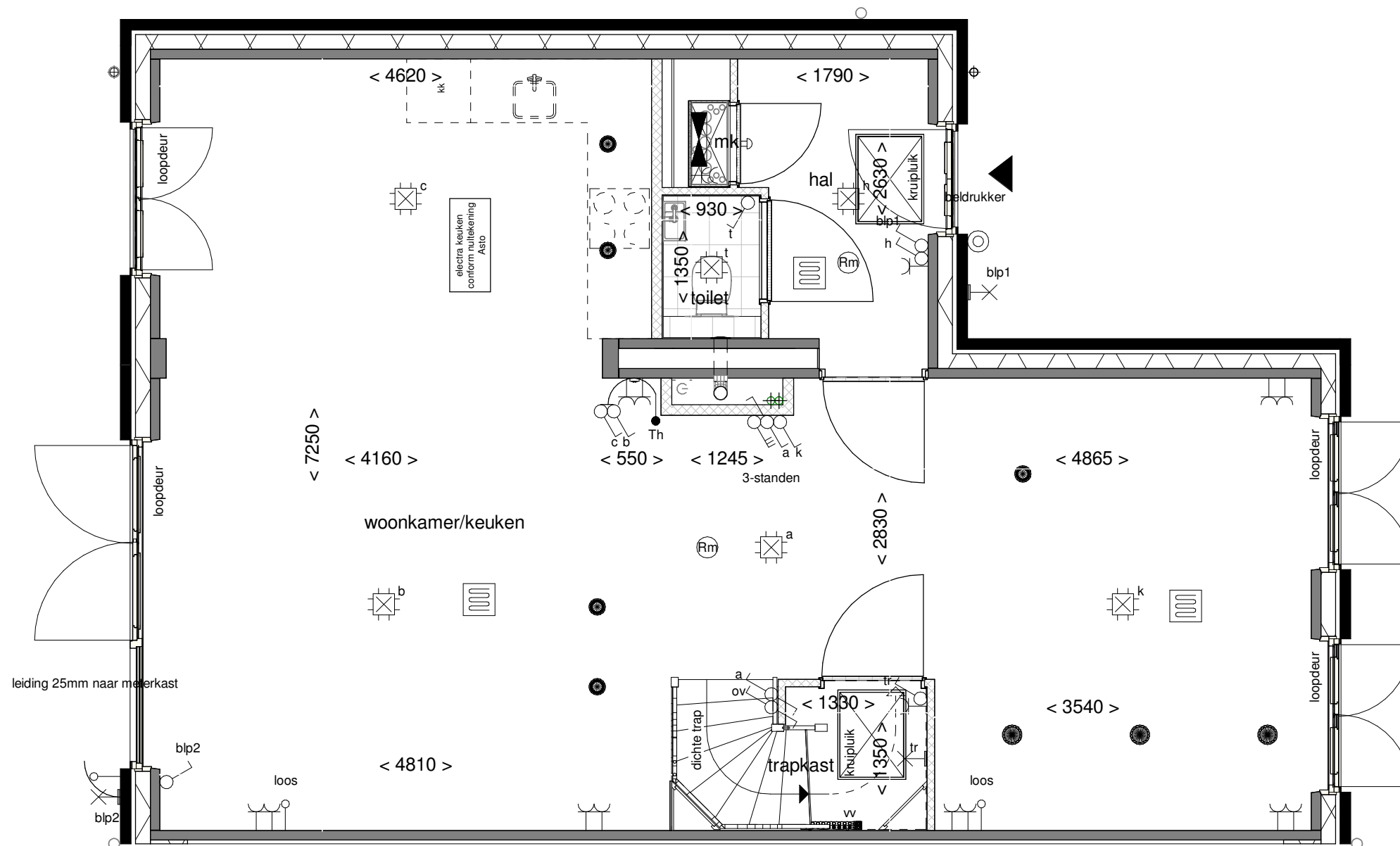

**ALLEMAAL  
YIELEYAAL**

Optie: Keuken in zij-uitbouw

Woningtype: Y45+U

Bouwnummer: -

Optienummer: 1.C.Y.12

Schaal: 1:50

Datum: 29-09-2021



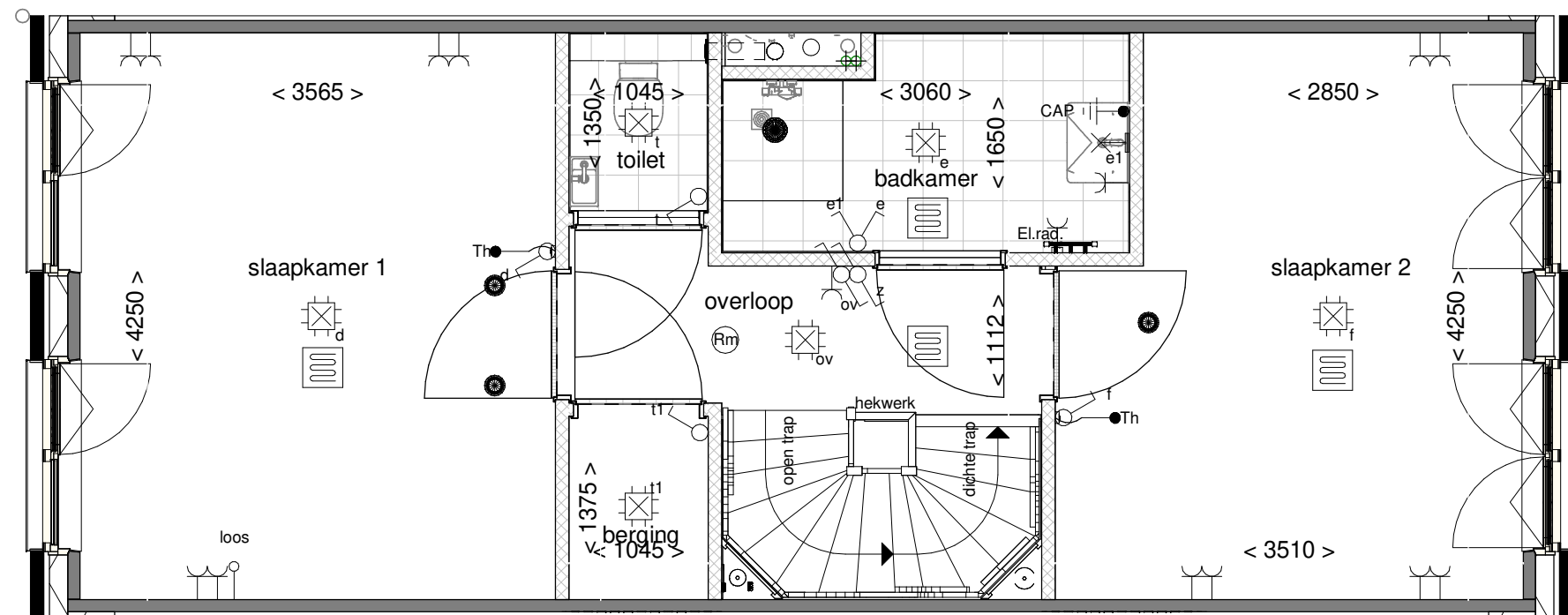

**ALLEMAAL  
YIELEYAAL**

Optie: Kast op overloop

Woningtype: Y45+

Bouwnummer: -

Optienummer: 1.C.Y.34

Schaal: 1:50

Datum: 29-09-2021

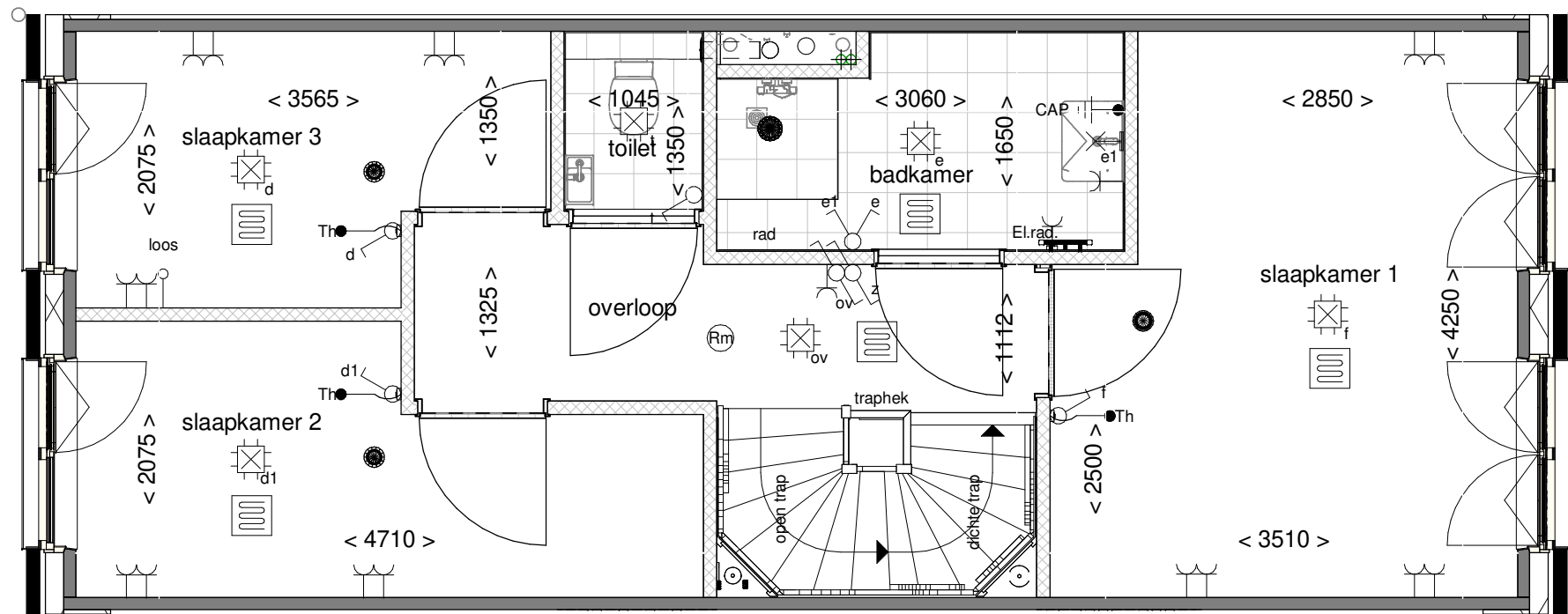

**ALLEMAAL  
YIELEYAAL**

Optie: Twee slaapkamers  
achterzijde

Woningtype: Y45+

Bouwnummer: -

Optienummer: 1.C.Y.36

Schaal: 1:50

Datum: 29-09-2021

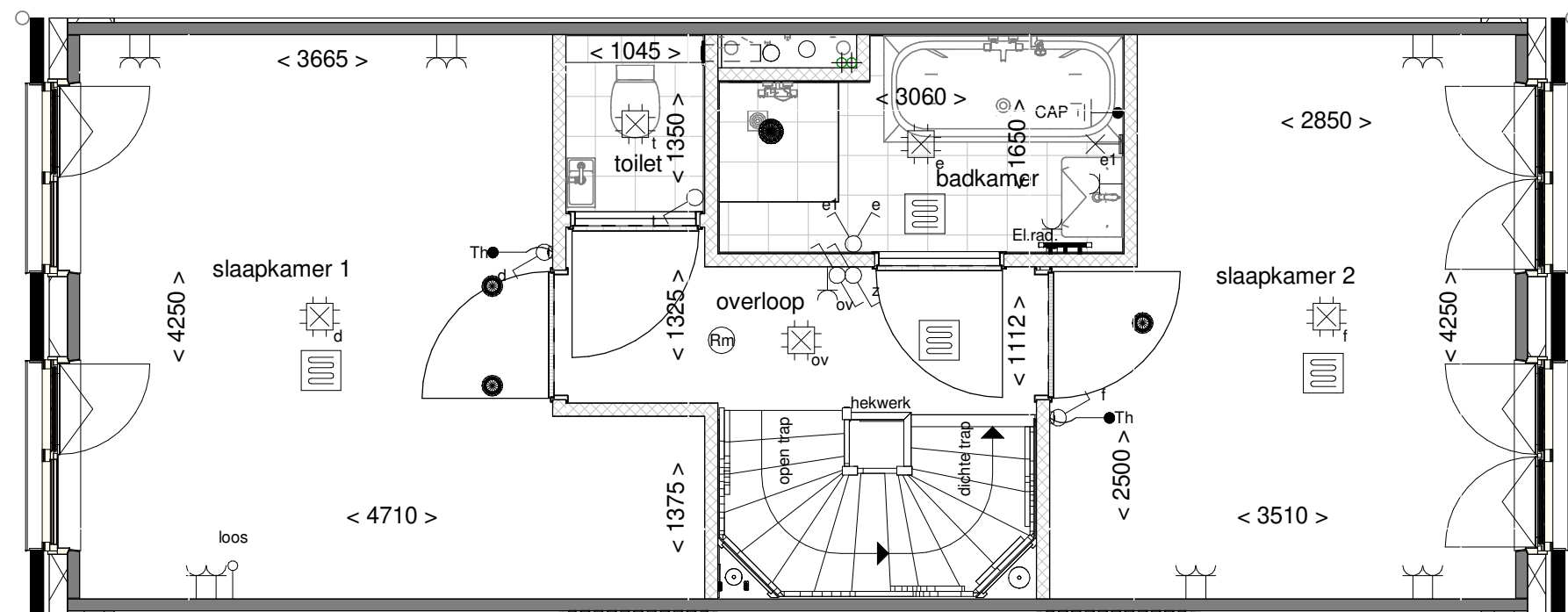

ALLEMAAL  
YIELEYAAL

Optie: Bad in badkamer

Woningtype: Y45+

Bouwnummer: -

Optienummer: 1.C.Y.40

Schaal: 1:50

Datum: 29-09-2021

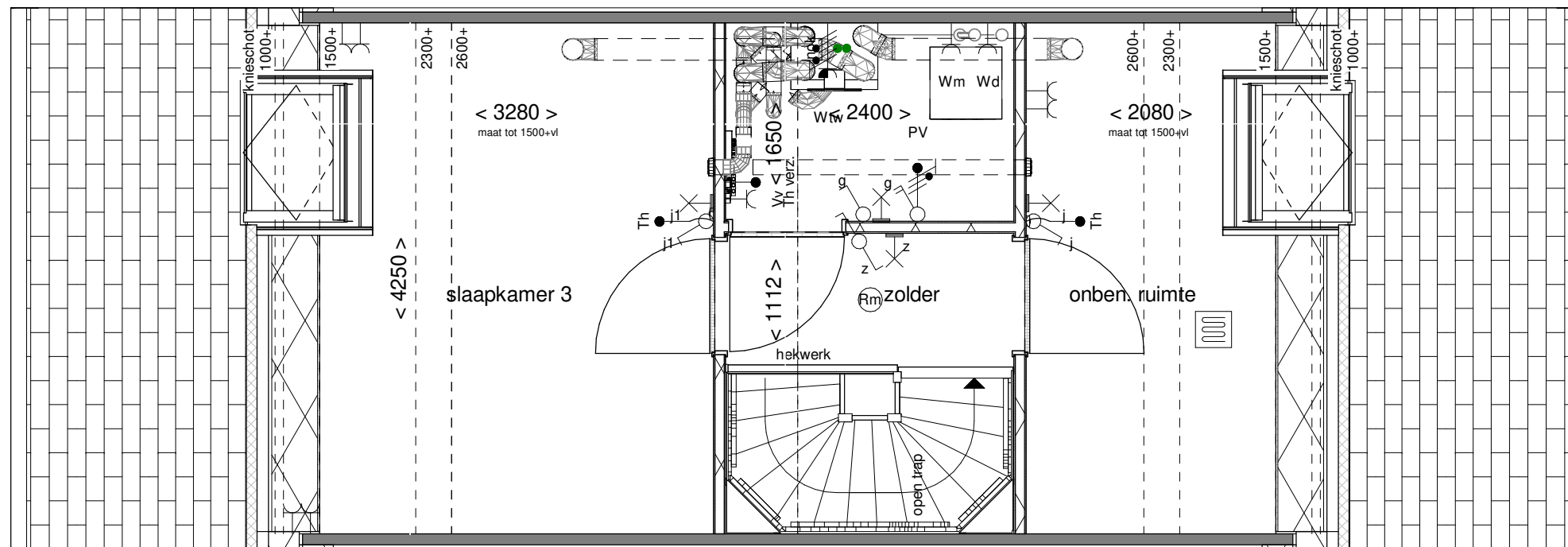

**ALLEMAAL  
YIELEYAAL**

Optie: Techn.- en onben.  
ruimte en slaapkamer

Woningtype: Y45+

Bouwnummer: -

Optienummer: 1.C.Y.78

Schaal: 1:50

Datum: 29-09-2021